

**BOOST COOLER™**

**INSTALLATION INSTRUCTIONS  
FOR PART #47103 Diesel TOW  
MAX™  
WATER / METHANOL INJECTION  
SYSTEM  
FOR UNIVERSAL TURBO DIESEL**



---

---

## CONTENTS

---

Kit Contents.....	3
Introduction.....	4
Nozzle Identification Chart.....	4
Installation - Mechanical.....	6
Installation - Electrical.....	12
Variable Controller Installation.....	12
Controller Operation.....	13
Variable Controller Tuning.....	15
Testing the System.....	16
Tuning Quick Reference.....	17
Fluid Level Switch.....	19
Install Notes.....	200
Warranty.....	21

Have a question?

FAQ: [www.snowperformance.net/faqs.php](http://www.snowperformance.net/faqs.php)

 **CAUTION**

You must completely read through these instructions before installing and operating this product. Failure to do so can result in damage to this product and the vehicle.

---

---

## Contact Us:

### Phone

Office	(719) 633-3811
Fax	(719) 633-3496
Tech Support Line (Toll Free)	(866) 365-2762

### Web

<http://www.snowperformance.net>

### Email

[sales@snowperformance.net](mailto:sales@snowperformance.net)  
[customerservice@snowperformance.net](mailto:customerservice@snowperformance.net)  
[tech@snowperformance.net](mailto:tech@snowperformance.net)

### Mail

Snow Performance, Inc  
1017-A East Highway 24  
Woodland Park, CO 80863

## Notes

The contents of this document are subject to change without prior notice. No part of or this entire document may be reproduced in any form without prior written permission of Snow Performance, Inc under the copyright except for private use.

The names, addresses and telephone numbers mentioned are current as of September 9, 2011. Note that this information is subject to change. Please refer to [www.snowperformance.net](http://www.snowperformance.net) for current information.

---

---

## LIMITATION OF LIABILITY

REPAIR OR REPLACEMENT OF A DEFECTIVE PRODUCT IS THE ORIGINAL RETAIL PURCHASER'S EXCLUSIVE REMEDY UNDER THIS WARRANTY. DAMAGE OR INJURY TO THE ORIGINAL RETAIL PURCHASER, TO HIS OR HER VEHICLE, CARGO, OR PROPERTY, AND/OR TO ANY OTHER PERSON OR PROPERTY IS NOT COVERED BY THIS WARRANTY. THIS WARRANTY IS EXPRESSLY MADE IN LIEU OF ANY AND ALL OTHER EXPRESS WARRANTIES, WHETHER ORAL OR WRITTEN. SNOW'S SOLE LIABILITY IS LIMITED TO THE REMEDY SET FORTH ABOVE. IN NO EVENT WILL SNOW BE LIABLE FOR ANY DIRECT, INDIRECT, CONSEQUENTIAL, INCIDENTAL, SPECIAL, EXEMPLARY, OR PUNITIVE DAMAGES OR FOR ANY OTHER DAMAGES OF ANY KIND OR NATURE (INCLUDING, BUT NOT LIMITED TO, LOST PROFITS OR LOST SALES). SOME STATES DO NOT ALLOW THE EXCLUSION OR LIMITATION OF INCIDENTAL OR CONSEQUENTIAL DAMAGES, SO THE ABOVE LIMITATIONS MAY NOT APPLY TO YOU.

## Non-Warranty Repair/Retest

Products returned due to damage or misuse and Products retested with no problem found are subject to repair/retest charges. Product will be returned to customer at customer's expense. A credit card number must be provided in order to obtain an RMA (Return Merchandise Authorization) number prior to returning Product.

---

---

## Kit Contents

---

### Parts

- UHO Pump (Ultra High Output)
- 7 Gallon Reservoir
- 25 ft High Pressure Tubing
- 3 ft Black Wire Loom
- 18" 1/8" Silicone Hose

### Electrical Pack

- 2 Blue Butt Connectors
- 3 Small Eyehooks
- 1 Male Connector
- 3 Female Connectors
- 10 Tie Wraps
- 1 Arm Switch
- 1 Brass Hose Barb
- 5" Double Sided Tape
- Diesel TOW MAX™ Controller
- Temperature Probe
- Yellow K-Type Temp Probe Connector

### Upgrades/Options

- 2.5 Gallon Reservoir
- Hose Adaptor or Bung
- Boost Juice
- Level Switch

### Mechanical Packets

- 1 Nozzle Holder
- 7 Gallon Fitting Set:
  - 90° Elbow
  - 3/8 Reducer Bushing w/ filter screen
- 4 #8x1&1/2" Screws
- 4 #8 Washers
- 1 Dual Nozzle Upgrade
- 1 Solenoid Upgrade
- 1 Temp Probe Compression Fitting – 3/16"
- 1 E-6000® (GOOP)
- 1 375ml/min Nozzle
- 2 625ml/min Nozzles

### Required Tools

Electric Drill w/ Drill Bits  
Utility Knife  
Screwdriver – Phillips  
Assorted Wrenches  
1/8" NPT Tap

---

---

## Introduction

The TOW MAX™ Diesel Boost Coolers™ are designed to maximize fuel economy and safe power while towing. This controller senses not only manifold boost pressure but also exhaust gas temperatures to control injection. Using two inputs allows for the smoothest injection control in the widest range of conditions.

More importantly, it also keeps the EGTs as low as possible – if they begin to climb, even if the boost stays constant, the TOW MAX™ controller will read this and inject more water-methanol to compensate.

The adjustments to the delivery on the fly are accomplished with two easy-to-use push buttons, allowing for more or less injection, or switching from both boost & EGT referenced injection (smoothest, best for towing and EGT control) to just boost referenced injection (most responsive, best for performance and racing).

Please refer to the following system diagram during install. Completely read through this instruction manual before attempting installation. Contact Snow Performance for any questions or concerns.

## Nozzle Identification Chart

Nozzle Number	Nozzle Size	Nozzle Number	Nozzle Size
1	60 ml/min	4	225 ml/min
2	100 ml/min	5	375 ml/min
3	175 ml/min	6	625 ml/min

---

---

## Warranty

### Warranty Policy

Snow Performance, Inc. warrants that the Product shall conform to and perform in accordance with published technical specifications and shall be free of defects in materials and workmanship for 90-days providing:

1. You are the original purchaser and provide proof of purchase.
2. For 1-year warranty, the Warranty Card that came with system (not applicable to separate parts purchases) is returned to Snow within 45-days of purchase. If valid warranty card not on file with Snow, the standard 90 day warranty applies from date of purchase.
3. For Lifetime warranty, the Warranty Card that came with system (not applicable to separate parts purchases) is returned to Snow within 45-days of purchase and Boost Juice® injection fluid is used exclusively.\*
3. An RMA # has been attained and is displayed on package containing returned part.
4. Parts Warranty ~ 90 day warranty on parts purchased separately if used in conjunction with a Snow System. No warranty implied if used with a non-Snow part/system.

Subject to Snow's inspection of the product, Snow will remedy defects in materials and/or workmanship by repairing or replacing, at Snow's option, the defective product without charge for parts or labor, subject to the limitations and exclusions described in this warranty.

This warranty does not cover problems caused by normal wear and tear including aesthetic oxidation of surfaces, accidents, unlawful vehicle operation, or modifications or repairs to product not performed or authorized by Snow. This includes any product that is disassembled or taken apart for any reason.

\* Boost Juice® usage evidenced by invoices/ receipts.

In addition, this warranty does not cover problems resulting from conditions beyond Snow's control including, but not limited to, theft, misuse, overloading, or failure to assemble, mount or use the product in accordance with Snow's written instructions or guidelines included with the product or made available to the original retail purchaser.

In the event of failure, Snow will repair or replace the part at Snow's sole discretion. Failures resulting from misapplication or misuse of the Product, failure to adhere to any specifications or instructions, or failure resulting from neglect, abuse, accidents, or act of nature are not covered under this warranty.

Warranty service may be obtained by calling 719-633-3811, getting an RMA (Return Merchandise Authorization), delivering the part to Snow along with proof of purchase. Customer agrees to insure the Product or assume the risk of loss or damage in transit, to prepay shipping charges to Snow, and to use the original shipping container or equivalent. Shipping for Warranty replacement parts shipped outside the continental US will be charged to customer.

### Non-Warranty Repair/Retest

Products returned due to damage or misuse and Products retested with no problem found will be returned to customer at customer's expense.

## Install Notes

Pump Setting \_\_\_\_\_ (psig)

Nozzle Size \_\_\_\_\_ (ml/min)

Controller Setting \_\_\_\_\_

Misc:

### Disclaimer

Do not use this product until you have carefully read the following agreement. This sets forth the terms and conditions for the use of this product. The installation of this product indicates that the BUYER has read and understands this agreement and accepts its terms and conditions. Performance products by their nature are designed to increase horsepower and performance not engineered in the original vehicle and the increased stress could result in damage to related systems. This is a high performance product – use at your own risk. Snow Performance Inc., Its agents, employees or owners shall not be under any liability whether in contract or otherwise whether or not resulting from our negligence or contents of information supplied for any damage or loss resulting from such information. The **BUYER** is responsible to fully understand the capability and limitations of his/her vehicle according to manufacturer specifications and agrees to hold the **SELLER** harmless from any damage resulting from failure to adhere to such specifications. The **SELLER** disclaims any warranty and expressly disclaims any liability for personal injury or damages. The **BUYER** acknowledges and agrees that the disclaimer of any liability for personal injury is a material term for this agreement and the **BUYER** agrees to indemnify the **SELLER** and to hold the **SELLER** harmless from any claim related to the item of the equipment purchased. Under no circumstances will the **SELLER** be liable for any damages or expenses by reason of use or sale of any such equipment. The **BUYER** is responsible to obey all applicable federal, state, and local laws, statutes, and ordinances when operating his/her vehicle, and the **BUYER** agrees to hold **SELLER** harmless from any violation thereof. The **SELLER** assumes no liability regarding the improper installation or misapplication of its products. It is the installer's responsibility to check for proper installation and if in doubt, contact the manufacturer.

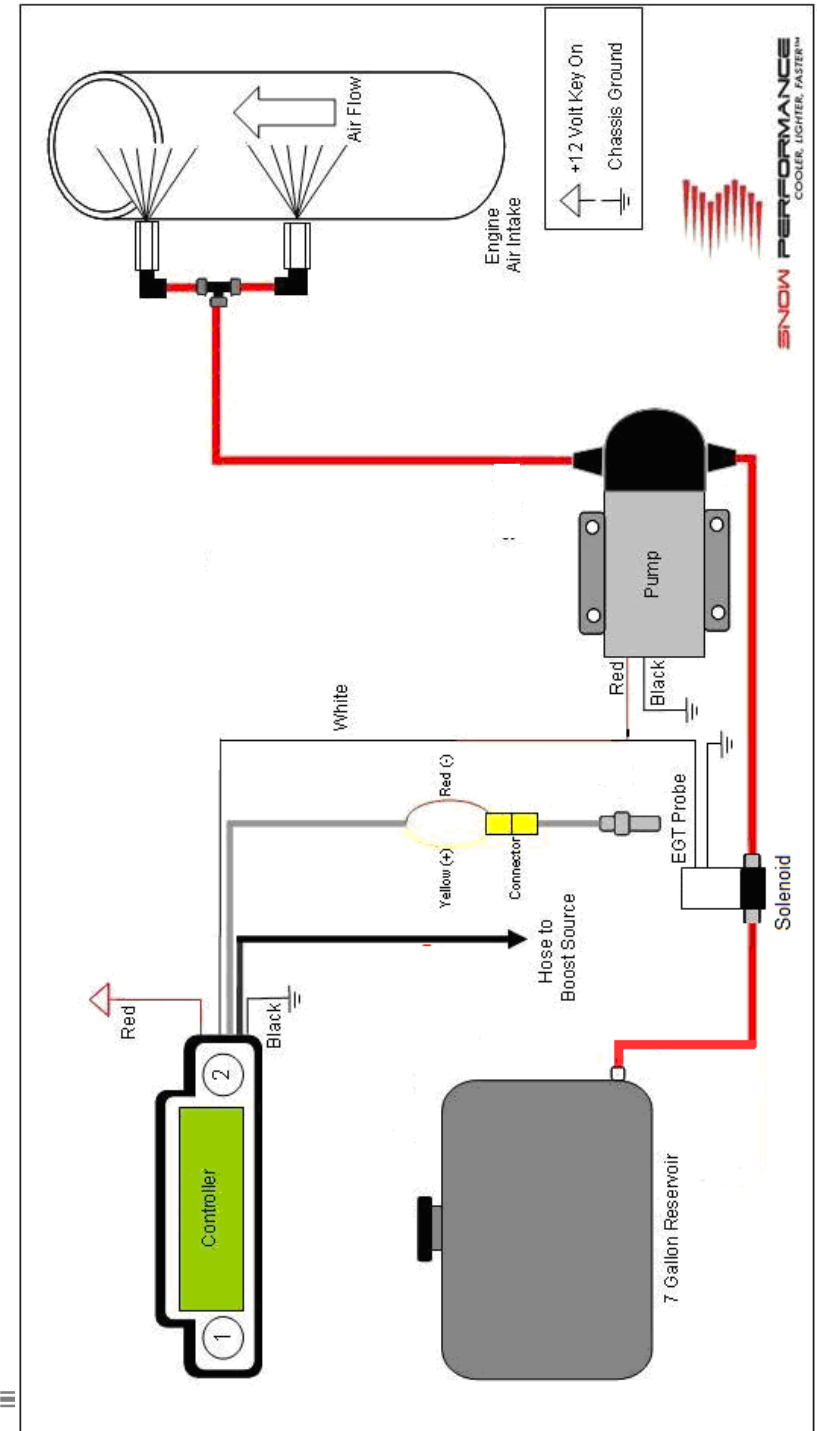

Note: The provided rocker switch is used on the controller power supply. The prong with the piece of plastic coming out with it connects to 12VDC key on power, the other prong connects to the RED wire on the controller.

Note: The system can use two nozzles simultaneously, but this is not always needed. Refer to the nozzle guide on page 8 for nozzle selection.

## Installation - Mechanical

### Step 1 Reservoir Install

- Install 90 degree elbow into reducer bushing using E6000 sealant. Turn ½ turn past finger tight. Do not use Teflon sealants on Snow Performance fittings. Install reducer bushing into reservoir outlet using E6000 sealant. Turn ½ turn past finger tight.



- Test fit reservoir in desired mounting location. Typical placement is tucked up along the side of a pickup bed or in a bed mounted tool box.
- Check the area under the bed near the desired mounting location. Note the location of fuel tanks, fuel lines, and wiring.
- Mark the location of the four aluminum mounting strap tab bolt holes.
- Drill through bed with appropriately sized drill bit. USE CAUTION WHILE DRILLING.

## Fluid Level Switch (optional)

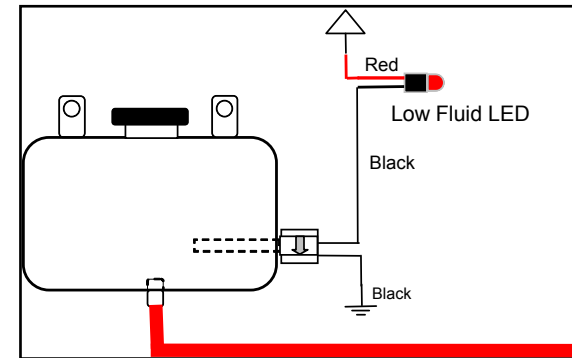

### Instructions

- Locate desired level switch mounting position. Suggested placement is 1/5 of max reservoir height.
- Carefully drill side of reservoir using 13/16" bit. A step bit is recommended for best drilling results. Hole must be free of nicks or shavings for proper sealing.
- Remove rubber seal from level switch. Insert seal into reservoir until fully seated. Goop can be used around the edges of the hole.
- Lubricate exterior of level switch with water and insert into seal until fully seated. Position level switch so **GT** symbol is at six o'clock position.
- Wait 30 minutes for Goop to cure, then test for leaks. With fluid level above level switch, float should be angled up. With fluid level below level switch, float should be in horizontal position.
- Connect one black wire from level switch to ground.
- Connect other black wire from level switch to white wire from LED.
- Connect red wire from LED to +12 volt key on power source.



---

---

## Caution\*\*\*\*\*

Prolonged quench may cause lower engine damage over a period of time.

---

Also, fresh methanol – less than 1 month old when exposed to atmosphere – and using a greater methanol concentration – up to 50% - will reduce combustion quench.

100% water will cool combustion and EGTs and will increase power approx 20-30 HP.

75/25 water/methanol will reduce EGTs and power will increase approximately 40 HP.

50/50 water/methanol will reduce EGTs and increase power approximately 70+ HP.

**Caution:** To avoid “pooling” in the it is recommended that:

1. The engine be run without water/methanol for at least 5 minutes after injection before turning the engine off.

2. The “armed switch” is turned to the off position when the engine is off.

**Caution:** Do not attempt to inject water/methanol until the engine has reach operating temperature. A cold engine is more susceptible to quench and poor performance.

**Maintenance – Remove nozzle(s) and clean screen filters at least once per year using carb cleaner.**

The Boost Cooler® has been designed to operate with high concentrations of methanol. Oil or other additives are not required for system lubrication.

For best performance, cooling and system life it is recommend that Snow Performance Boost Juice™ (#40008) be the exclusive fluid used in the system.

- 
- 
- Mount reservoir with aluminum mounting straps using appropriate hardware.
- 

## Caution\*\*\*\*\*

To avoid gravity feeding of fluid with rear mount reservoirs, it is essential to use a solenoid in-line between the reservoir and pump. **Do not operate** your rear mount equipped vehicle without a solenoid installed.

---

### Step 2 Pump Install

Mount pump so the pump inlet is positioned at the lowest point of the reservoir or lower. Pump can be mounted horizontally or vertically using the supplied screws and washers. Ensure that no sharp bends in the high pressure tube occur near the pump. Sharp bends can cause stress on the inlet and outlet ports of the pump, causing leaks. Trim tube with a utility knife or razor blade, making sure to eliminate any burrs or kinks on the end. Insert firmly into the pump about ½ inch through the light grey locking collar. Note the arrows indicating flow direction on the top of the pump. To remove the hose, gently and evenly push the light grey locking collar into the head unit of the pump, then pull on the hose gently.



---

---

Measure the distance from the reservoir outlet to the pump inlet. Cut the ¼" red tubing using utility knife. Make cuts are as square as possible.

Ensure there are no kinks in the tubing and insert tubing into quick disconnects at pump and reservoir until fully seated. Keep the pump within 2 feet of the reservoir. The pump can be mounted under the truck bed in a place protected from road spray.

---

## Caution\*\*\*\*\*

Pump must be shielded from road debris and tire wash. Failure to do so will result in pump failure

---



If pump goes on and fluid level doesn't go down, there is an obstruction in the tube or nozzle. Activation of pump for short periods (1 - 5 sec.) will purge air bubbles from the system after installation. This can be accomplished during initial use.

### Step 3 Test Controller

- With the nozzles removed from the intake, place the controller in "boost only" mode by disabling the EGT Control mode. Set gain to 100.
- Disconnect the silicone boost line from the 'T' fitting at the intake boost line.
- Using a hand pump, apply 10-20 psig of pressure to the boost line.
- Pump should activate, fluid should flow, and tank level should go down.

## Tuning Quick Reference

If combustion quench occurs as evidenced by engine "bucking", reduce the injection quantity. This can be done by:

1. Using a smaller nozzle(s).
2. Using Screen 10 and Screen 11 to adjust the gain.



in racing and day to day applications where more immediate injection is desired.

- Toggle to Screen 8. Set EGT Control to OFF.
- If combustion quench occurs as evidenced by engine “bucking”, reduce the injection quantity or lower the gain setting on the module. This can be done by:
  - Using a smaller nozzle(s).
  - Adjusting the gain.
- To adjust gain down, toggle to screen 11. Adjust the gain down until engine runs smooth with no bucking.

#### Example:

For a truck making 30-35 PSI maximum boost and about 400HP, use a 625 and a 375 nozzle. Set the boost range to High and leave gain at 100%.

## Testing the System

### Step 1 for best results, prime pump before use

To clear air from the pump and insure that the system is primed:

- Fill reservoir with water approx ¼ full.
- Remove tubing from nozzle (or solenoid if solenoid used in-line between pump and nozzle) and run tube into separate container.
- Apply 12 VDC to red pump wire for approximately 5 seconds or until fluid flow is consistent.
- Pump is now primed. Reconnect tubing from pump outlet to nozzle (or solenoid).

**If using a solenoid in between the pump and the reservoir:** Remove the solenoid and place a solid piece of tube between the pump and the reservoir and prime the system. Then replace the solenoid in between the pump and reservoir.

### Step 2 Test Pump and Mechanical System

Disconnect pump from controller. Using a 12 volt source, apply power to red wire of pump. Pump should activate and fluid level in tank should go down. It is recommended to also check the nozzle spray pattern while following this procedure. Also check for leaks.

## Step 3 Nozzle Selection

Nozzle sizing is a function of horsepower, which approximates the engine airflow, and boost, which approximates intake charge heat. Recommended starting points:

250 - 400 WHP	625 ml/min nozzle
425 - 525 WHP	375 & 625 ml/min nozzle
550 - 650 WHP	2 X 625 ml/min nozzles

**TECH TIP** Seal the nozzle into the nozzle holder using included GOOP® sealant. Using a sealant that is not permanent will allow for nozzle changes during tuning. Simply remove the nozzle, clean the threads, and reinstall using sealant.

Assemble desired nozzle into nozzle holder using E6000® sealant. **The end of the nozzle with the fine mesh screen is to be inserted into the nozzle holder.** Torque 1/2 turn past finger tight. Do not use Teflon sealants on Snow Performance fittings.



Correct



Incorrect

**NOTE:** If nozzle is mounted lower than the reservoir, a solenoid (#40060) must be used to prevent draining.

---

---

## Step 4 Nozzle Mounting

The nozzle assembly should be installed 90° to the direction of airflow. On round intake tubes, this is 360° around the tube meaning the nozzle can be mounted in any direction. This will ensure maximum cooling as the nozzle sprays in a cone pattern. Choose and mark mounting location for nozzle placement. Nozzles can be placed in a variety of places on the charge pipe between the intercooler outlet and the intake inlet, so long as they have a clear spray pattern into the airflow, and the nozzle tip is flush with the inside wall of the tube or protruding slightly into the airflow.

Drill and tap (11/32" pre-drill, 1/8"-27 NPT tap) for nozzle(s).



**Optional Weld-In Bung Shown**

The nozzle is mounted using its external 1/8 NPT threads. Tighten the nozzle and nozzle holder assembly one half turn past finger tight using E6000® sealant.

---

---

## Screen 9

Boost Range  
Change

This screen is used to select between LOW, MED, and HI boost mode. **For vehicles making 8-18 psi of boost, use LOW mode. For vehicles making 18-25 psi of boost, use MED mode. For vehicles making 25+ psi of boost, use HI mode.**

## Screen 10

Injection Gain  
Increase

This screen is used to increase the injection gain setting. Pressing and releasing Button 2 will increase the gain setting. This setting is also remembered on power up.

## Screen 11

Injection Gain  
Decrease

This screen is used to decrease the injection gain setting. Pressing and releasing Button 2 will decrease the gain setting. This setting is also remembered on power up. **5%-10% changes in Gain have a significant impact on injection.**

## Variable Controller Tuning

### EGT Control Mode

When EGT Control mode is enabled, the controller will measure EGTs and boost pressure to calculate the injection rate. This is ideal for towing or heavily loaded situations. In this mode, a high gain setting will result in a larger injection rate.

- Toggle to Screen 8. Set EGT Control to ON.
- Toggle to Screen 10. Adjust the gain up to 100.
- If combustion quench occurs as evidenced by engine “bucking”, reduce the injection quantity or lower the gain setting on the module. This can be done by:
  - Using a smaller nozzle(s).
  - Adjusting the gain.
- To adjust gain down, toggle to screen 11. Adjust the gain down until engine runs smooth with no bucking.

### Boost Only Mode

The controller has a “boost only” mode. When EGT Control mode is disabled, injection is a function of boost pressure only which is desirable

### Screen 1

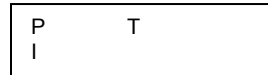

This mode displays Boost Pressure (P), Temperature (T) and Injection percentage (I) as three independent bar graphs. The pressure scale is scaled proportional to the Lo/Hi boost selection.

### Screen 2

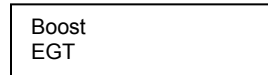

This mode displays the boost pressure and EGT temperature in PSI and °F.

### Screen 3



This mode displays the boost pressure and EGT temperature in BAR and °C.

### Screen 4

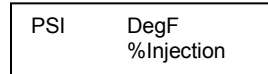

This mode displays the boost, EGT and injection in English units.

### Screen 5

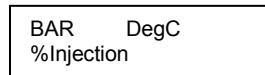

This mode displays the boost, EGT and injection in Metric units

### Screen 6

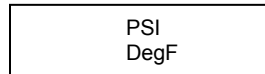

This display shows both digital and bar graph readings for boost and EGT in English units.

### Screen 7

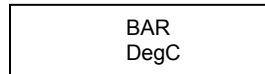

This display shows both digital and bar graph readings for boost and EGT in Metric units.

### Screen 8

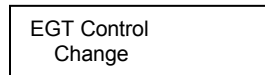

This is the setup screen for the “Boost Only” control mode. Pressing the right Button (button 2) will toggle the setting between EGT Control ON and OFF. If the “EGT Control” is ON, the matrix value for the injection is used. If the “EGT Control” is OFF, the “Boost Only” injection setting will be used. The selection of this function is also stored in system memory and recalled on power on. EGT Control is useful during towing or on long grades.

## Step 5 Nozzle Connection and Solenoid Connection

Solenoid is flow directional. Be sure to note which port is the INLET/PRESSURE port (2 or IN) and which is the OUTLET port (1 or OUT).

**The main outlet line coming from the Reservoir connects to the solenoids inlet. The outlet of the solenoid connects to the inlet of the pump.**

Measure the distance from the pump outlet to the nozzle holder. Cut the ¼” red tubing using utility knife. Make cuts are as square as possible. Ensure there are no kinks in the tubing and insert tubing into quick disconnects until fully seated. Gently pull on tubing to ensure a good connection.

Use tie wraps to help route tubing and to ensure it doesn't contact moving or hot parts in the engine compartment. Have tubing connect to quick connect fittings at shallow angles. Having an immediate sharp bend may unseat the tubing from the internal o-ring and create a leak.

Continual insertion and removal from quick connect fittings will mar the end of the tubing. Over time the internal gripping teeth may lose their hold of the tubing which may create a leak. If this occurs simply remove the tubing and make a fresh cut using a razor blade.

## Step 6 Install EGT Probe

Drill and tap exhaust manifold pre-turbo. If this is performed with the exhaust manifold still on the engine, start the engine and let it idle while drilling and tapping. This will prevent shavings from entering the exhaust and turbo. During tapping, coat tap with heavy grease so it will collect metal shavings.



Mount the Temp Probe using the compression fitting (provided).

## Installation - Electrical

### Variable Controller Installation



Attach controller to secure location with easy access in driver's compartment using supplied tape. Connect black silicone tubing from intake plenum boost line (using the included 'T' fitting) to clear tubing coming from the controller and secure with tie wraps.

**⚠ CAUTION: Disconnect the negative battery terminal while connecting wires to prevent electrical fire or damage to controller.**

- Connect BLACK wire to a good ground location.

- Connect WHITE wire to Pump RED power wire.
- Connect RED wire to +12 volt key on source with inline switch.
- Wire the Yellow "K" type temp probe connector to temp probe installed in Step 6 above. The YELLOW wire connects to the POSITIVE terminal, the RED wire connects to the NEGATIVE terminal of the connector. Connect to the lead from control module.

**TECH TIP** Always have a good electrical ground connection. Poor ground will result in erratic operation of controller.

### Controller Operation

The controller has an LCD display screen. The display software allows for seven different display "modes" and four control/setup screens.

To control the screen selection, the unit has two operator buttons; one to the left of the screen (Button 1) and one to the right of the screen (Button 2). Pressing and releasing Button 1 will cause the display to sequence to the next mode. Button 2 is only active in the control/setup screens, and is used to change the setting on the setup screen displayed.

The system memory will remember the current display setting even if the unit is turned off. The controller will turn on at the last used display setting.

Additionally, Button 2 is used for the "Injection ON/OFF" function.

**Pressing and holding Button 2, then pressing Button 1, then releasing both buttons will change the system to read only without changing the display screen. The pump will not activate in read only. All screen display functions will remain active even when the injection is turned off. To get the controller out of read only mode, just repeat the procedure.**