

with Installation Instructions

Owner's Manual

Banks Techni-Cooler® Intercooler System

2006-2010 Chevy/GMC Turbo-Diesel Pickup Trucks

THIS MANUAL IS FOR USE WITH TECHNI-COOLER INTERCOOLER
SYSTEM 25982

Gale Banks Engineering
546 Duggan Avenue • Azusa, CA 91702
(626) 969-9600 • Fax (626) 334-1743

Product Information & Sales: (888) 635-4565

bankspower.com

General Installation Practices

Dear Customer,

If you have any questions concerning the installation of your Banks Techni-Cooler, please call our Technical Service Hotline at (888) 839-2700 between 7:00 am and 5:00 pm (PT). If you have any questions relating to shipping or billing, please contact our Customer Service Department at (888) 839-5600.

Thank you.

- 1.** Before starting work, familiarize yourself with the installation procedure by reading all of the instructions.
- 2.** Throughout this manual, the left side of the vehicle refers to the driver's side, and the right side to the passenger's side.
- 3.** Disconnect the negative (ground) cable from the battery (or batteries, if there are two) before beginning work.
- 4.** Route and tie wires and hoses a minimum of 6" away from exhaust heat, moving parts and sharp edges. Clearance of 8" or more is recommended where possible.
- 5.** When raising the vehicle, support it on properly weight-rated safety stands, ramps or a commercial hoist. Follow the manufacturer's safety precautions. Take care to balance the vehicle to prevent it from slipping or falling. When using ramps, be sure the front wheels are centered squarely on

the topsides. When raising the front of the vehicle, put the transmission in park (automatic) or reverse (manual), set the parking brake, and block the rear wheels. When raising the back of the vehicle, be sure the vehicle is on level ground and the front wheels are blocked securely.

Caution! Do not use floor jacks to support the vehicle while working under it. Do not raise the vehicle onto concrete blocks, masonry or any other item not intended specifically for this use.

6. During installation, keep the work area clean. Do not allow anything to be dropped into intake, exhaust, or lubrication system components while performing the installation, as foreign objects will cause immediate engine damage upon start-up.

TOOLS REQUIRED:

- Drive ratchet
- Ratchet extension
- Inch and metric deep sockets
- Pliers
- Phillips and flat blade screwdrivers
- Torx bits

HIGHLY RECOMMENDED TOOLS:

- Foot-pound torque wrench
- Inch-pound torque wrench

REMOVE STOCK INTERCOOLER

1. Disconnect the ground cables from both the driver and passenger side batteries. Position the loose cables so that they do not come into contact with their respective battery posts during the installation.

2. Remove air box filter assembly.

Loosen the hose clamp from the stock intake tube on the turbo inlet. Separate the stock intake tube connected to the turbo inlet. Remove the Air Flow (MAF) sensor connector from stock air box filter cover. Remove stock air box by lifting the air box up and out. The bottom of the stock air box is held in place by rubber grommets. There may be some slight resistance when removing the stock air box. See **Figure 1**.

NOTE: Be careful not to damage the connector or the MAF sensor.

3. Remove the upper grill baffle.

Remove the upper grill baffle that mounts between the grill and radiator cross brace. The baffle is held in place by 7 push-in retainers. The retainers are removed by pulling up on the center pin, then prying the retainer out of it's hole as shown in **Figure 2**.

4. Pull the grill from the vehicle.

2006-07 LBZ: Remove the grill by disengaging the 6 snaps at the outboard ends of the grill.

07-10 LMM: Remove the grill by disengaging the 8 clips at the outboard ends of the grill and (4), 10mm bolts at located on top of grill.

NOTE: Some 08 Models may require that you remove the trim from the top of the bumper for ease of installation.

Figure 1



Figure 2 Removal of Push-In Retaining Pins

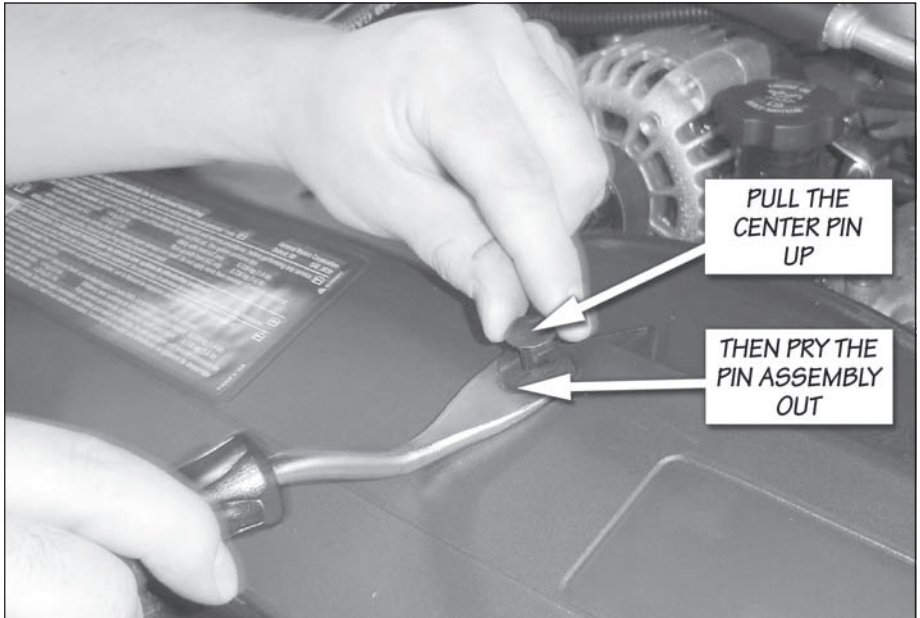

5. Remove the inner fenderwell.

2006-07 LBZ: Remove the 8 pushpin fasteners and 2 large head plastic fasteners that attach both driver's and passenger's side fenderwell.

07-10 LMM: Remove the 6 pushpin fasteners and (4) 7mm and (1) 10mm bolts from both driver's and passenger's side fenderwell.

NOTE: ALL YEARS The fasteners are accessed through the wheel arch opening. Pull the fenderwell down approximately 6 inches once the fasteners are removed. Disconnect the wire harness retaining clips on top of the fenderwell, and then remove the fenderwell from the vehicle.

6. Disconnect connectors from headlamp assemblies and remove headlamp assemblies.

2006-07 LBZ: Rotate the headlamp retaining pin, then remove the pin

as shown in **Figure 3**. Disconnect the connectors from the backside of the headlamp assembly, and remove both driver's and passenger headlamp assemblies from the vehicle. Next, remove the park/turn signal lamp assembly by depressing the outboard retaining clip, then rotating the assembly outward as shown in **Figure 4**. Remove the bulbs from the turn signal lamp assembly by turning the lamp sockets a quarter turn counterclockwise.

NOTE: The headlamp is easily disengaged and does not require force to be removed once the outboard clip has been depressed.

07-10 LMM: The headlamp assembly is secured with 3 bolts. Remove the bolts to the headlamp assembly.

Attention: Number and location of bolts on the headlamp assembly may vary by model and year.

Figure 3 2006-07 LBZ: Headlamp Assembly Removal

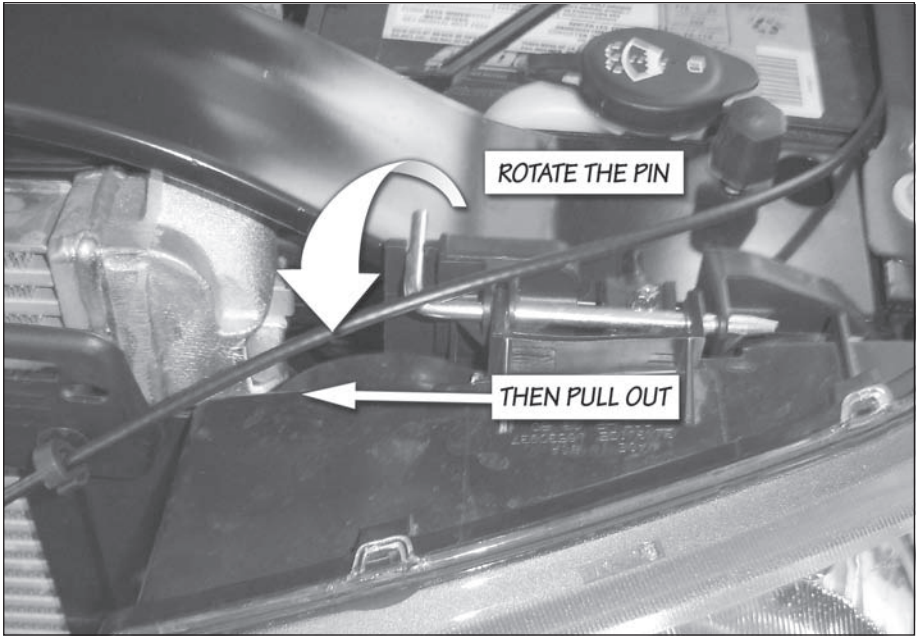

Figure 4 2006-07 LBZ: Parking Lamp Assembly Removal

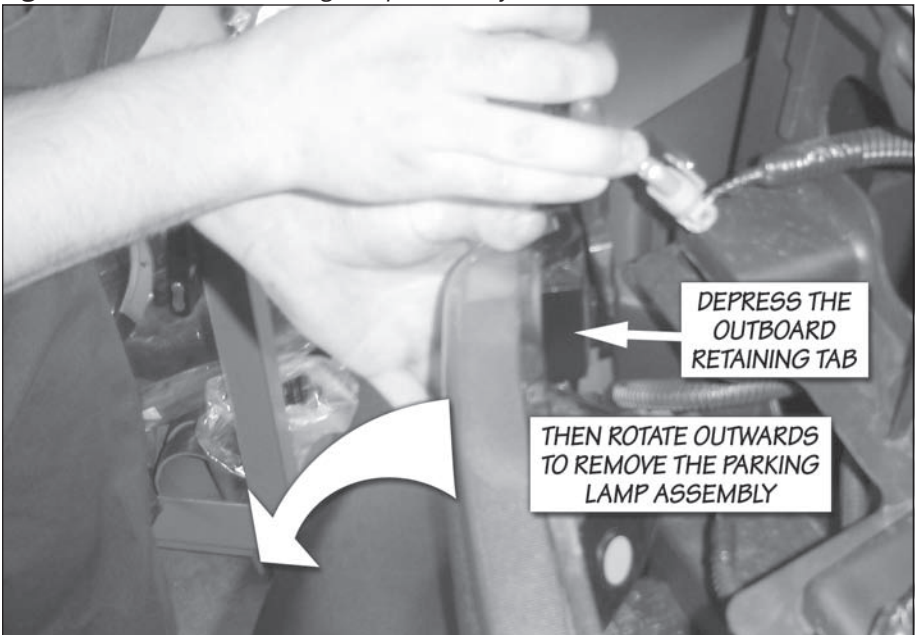
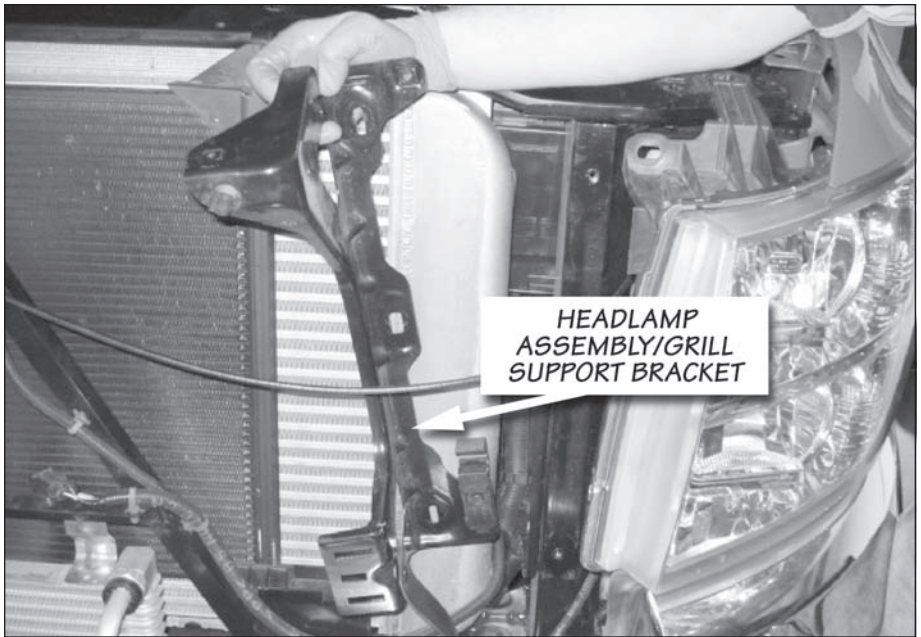

Figure 5 07-10 LMM: Headlamp Assembly/Grill Support Bracket



*NOTE: The inner fenderwell cover must be removed to access the bottom bolt. Next, remove the (3 per side) bolts to the head assembly / grill support bracket. See **Figure 5**. Disconnect the connectors from the backside of the headlamp assembly from both driver and passenger headlamp assemblies. Remove the headlamp assemblies.*

NOTE: Slide the headlamp assembly toward the center and forward of the vehicle to remove. The turn signals are built into the headlamp assembly.

7. Remove the plastic headlamp mounting structure. (2006-07 LBZ only)

2006-07 LBZ: Remove the plastic headlamp mounting structure on the driver and passenger side of the vehicle shown in **Figure 6**. There are (6x) bolts, (2x) torx head bolts, (1x) push-in retainer and (1x) large clip that must be disconnected to remove

the piece from the vehicle, per side. The plastic piece that resides by the bumper must be detached from the headlamp mounting structure, but will remain on the vehicle. The retaining clip that attaches the hood latch cable to the support structure must also be removed on the driver's side.

8. Remove the two bolts that secure the upper fan shroud to the upper radiator cross brace. Remove the four push-in retainers (2 per side) that attach the upper section to the lower section of the fan shroud. These retainers are removed by pulling up on the center pin then prying the entire retainer assembly out as shown in **Figure 2**.

9. Carefully remove the transmission module from the upper fan shroud. Lay the module to the side. See **Figure 7**.

Figure 6 '06-07 LBZ: Removal of Headlamp/Parking Lamp Assembly Support Structures.

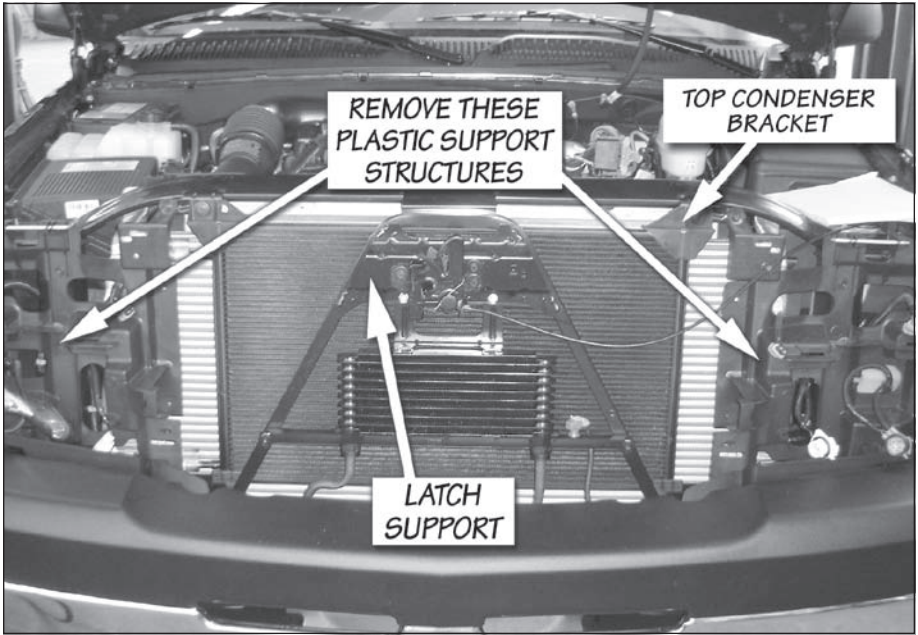
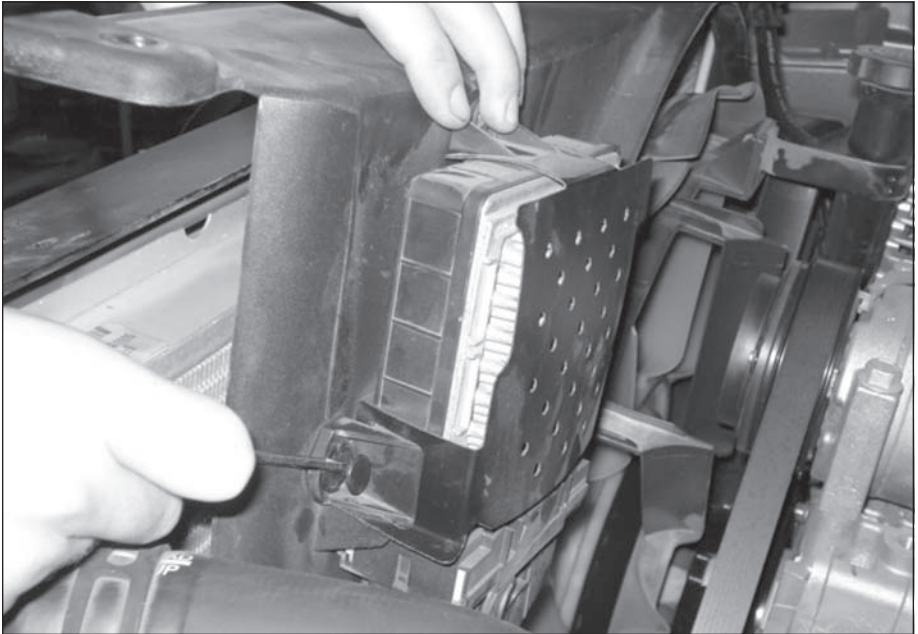

Figure 7 Transmission module



10. Remove the low pressure A/C condenser line from the line retainer attached to the upper fan shroud.

11. Remove the upper section of the fan shroud from the vehicle. Take care not to damage the face of the radiator when removing the shroud.

12. Remove the two upper condenser mounting bolts that attach to the radiator cross brace.

13. Mark the location of the hood latch, then remove the hood latch from the latch support. The latch is held in place by three bolts. The latch support is shown in **Figure 6**. It is not necessary to remove the cable from the latch, just place the latch and cable assembly out of the way.

14. Remove the two bolts that attach the latch support to the radiator cross brace and the 4 lower attachment bolts (2 per side). The two bolts that attach the upper support to the radiator cross brace are accessed from the engine compartment side of the vehicle.

15. 07-10 LMM: Only Remove the (2) top oil cooler bracket to free the oil cooler from the latch support bracket. See **Figure 8**.

16. Swing the latch support forward as shown in **Figure 9**.

17. Pull the air conditioning condenser out of it's lower mounts, and place it against the latch support.

18. Remove the two upper Charge Air Cooler (CAC) mounting bolts and unfasten the fender support rod from the cross brace as shown in **Figure 10**.

19. Remove the 6 bolts (3 per side) that secure the radiator cross brace. The cross brace is shown in **Figure 10**. The bolts are on the bottom side at each end of the support. Remove the cross brace from the vehicle.

20. Remove the air box-mounting tray from the vehicle shown in **Figure 11**.

Figure 8 07-09 LMM: Shown

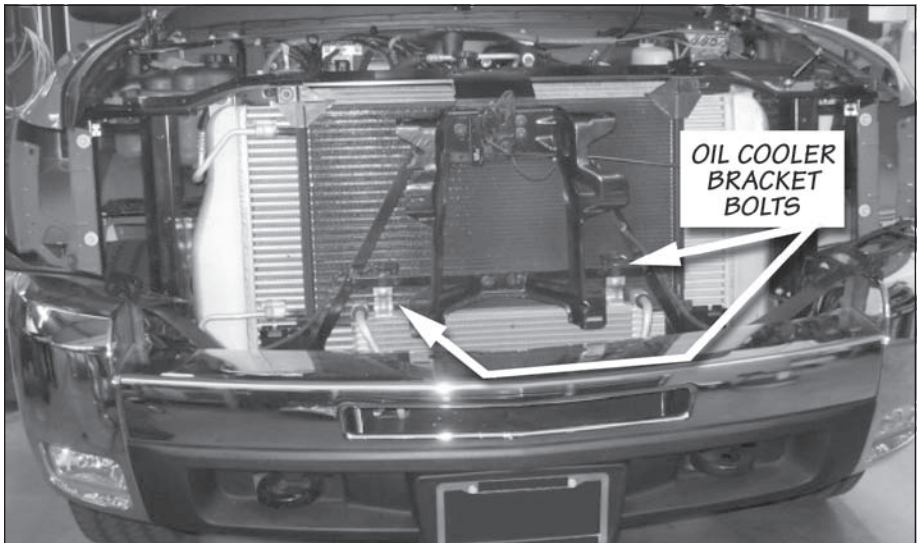

This page left blank intentionally

Fig 13. Trim template for the air box-mounting bracket.

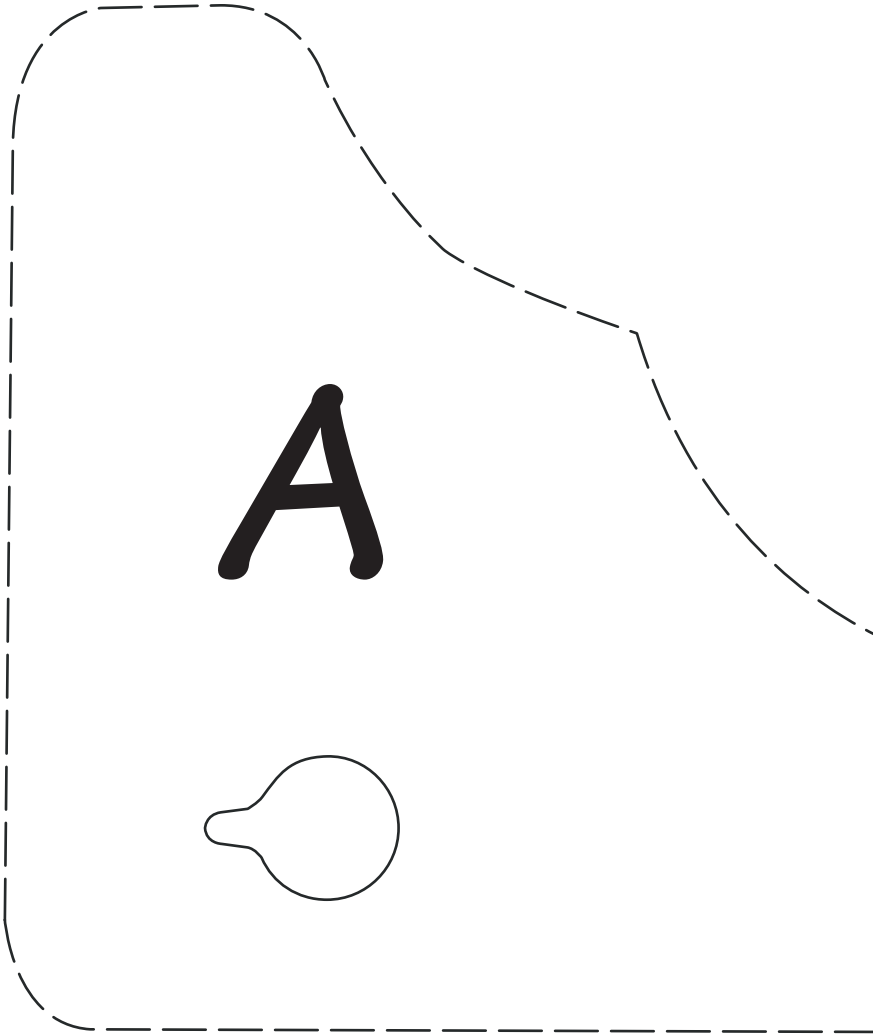

This page left blank intentionally

Fig 14. Trim template for the air box-mounting bracket.

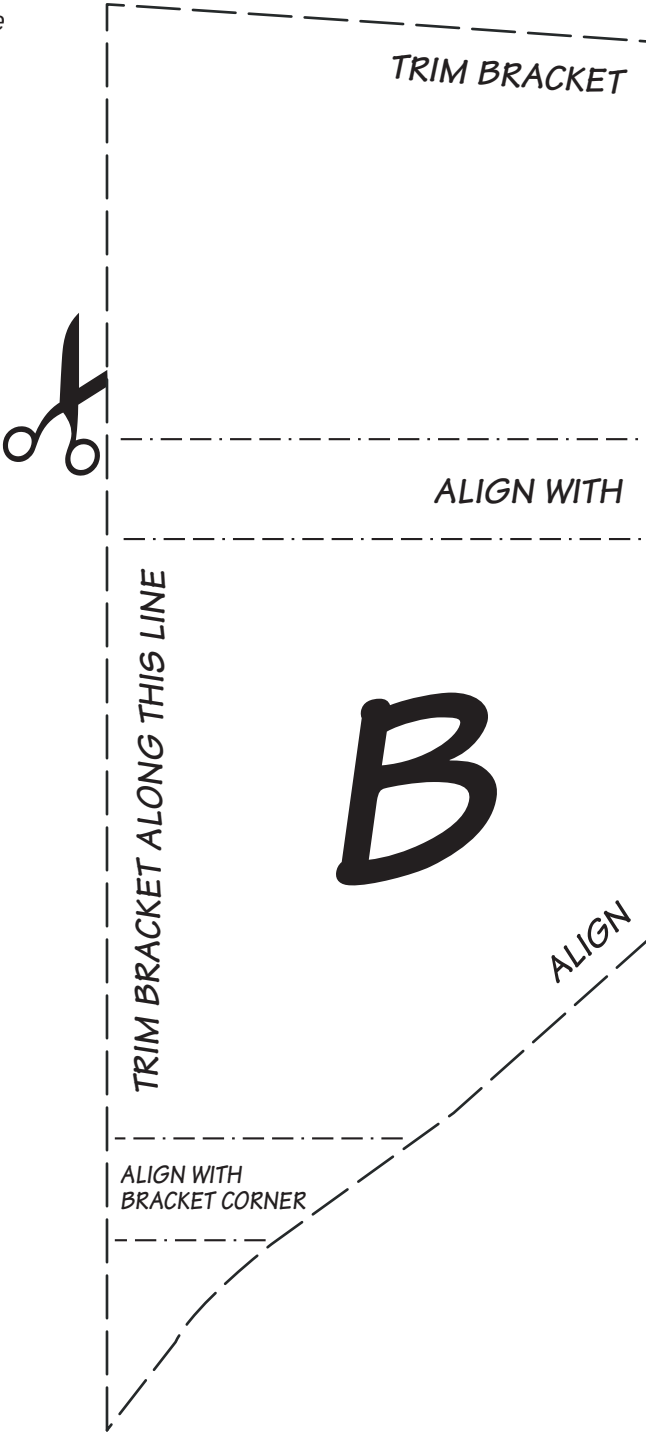

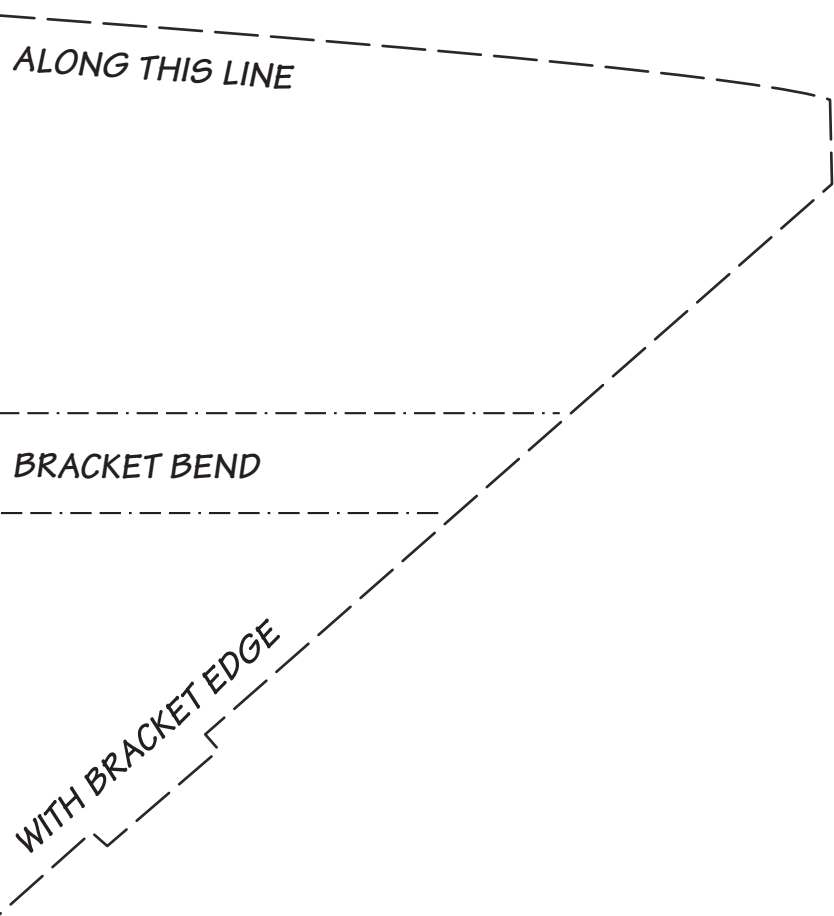

This page left blank intentionally

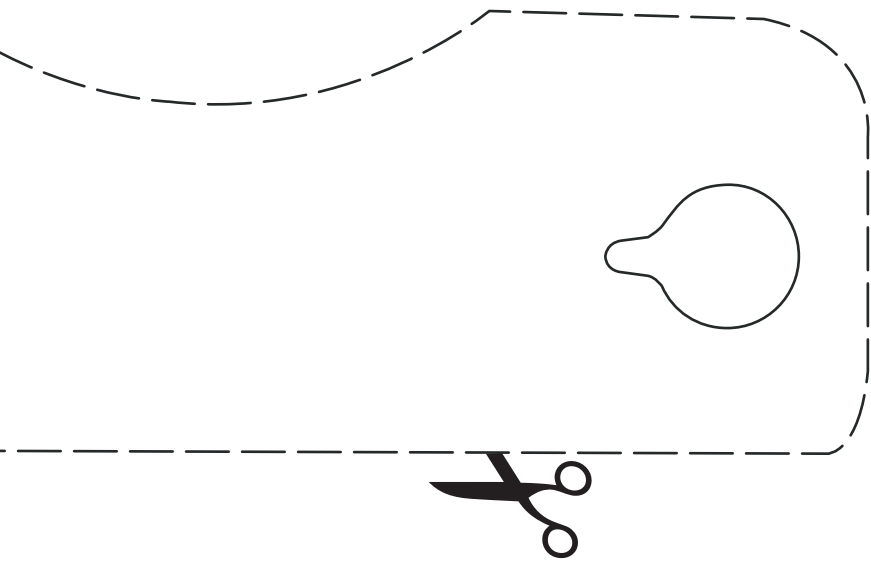

This page left blank intentionally

Figure 9 Latch Support Moved Out of the Way

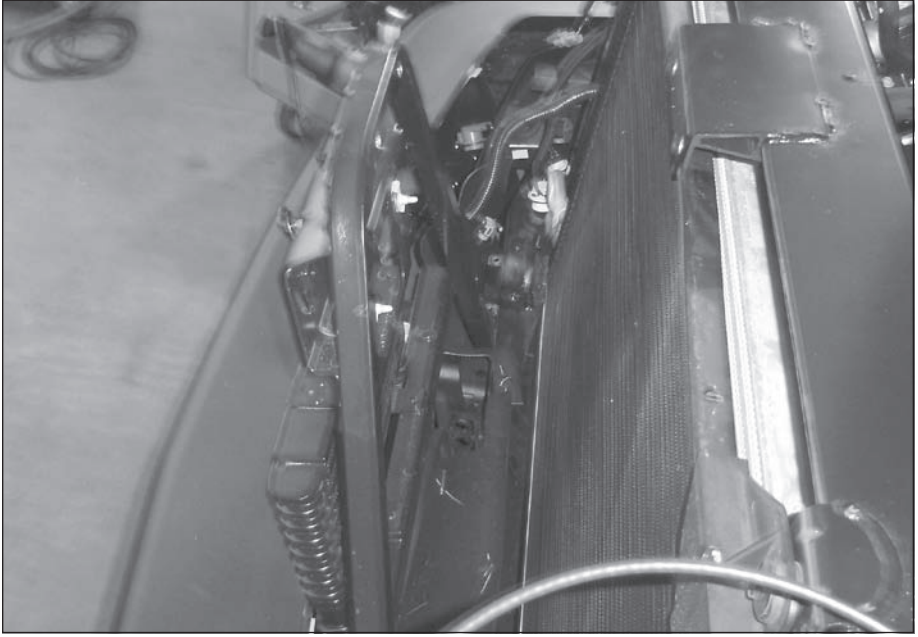

Figure 10 Upper Intercooler (CAC) Attachment Bolt.

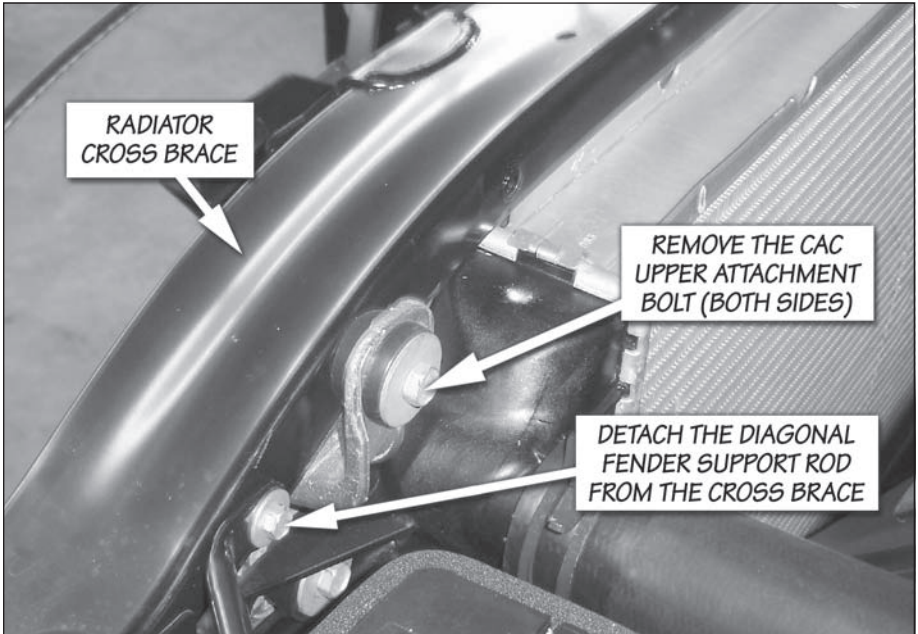

Figure 11 Air box tray

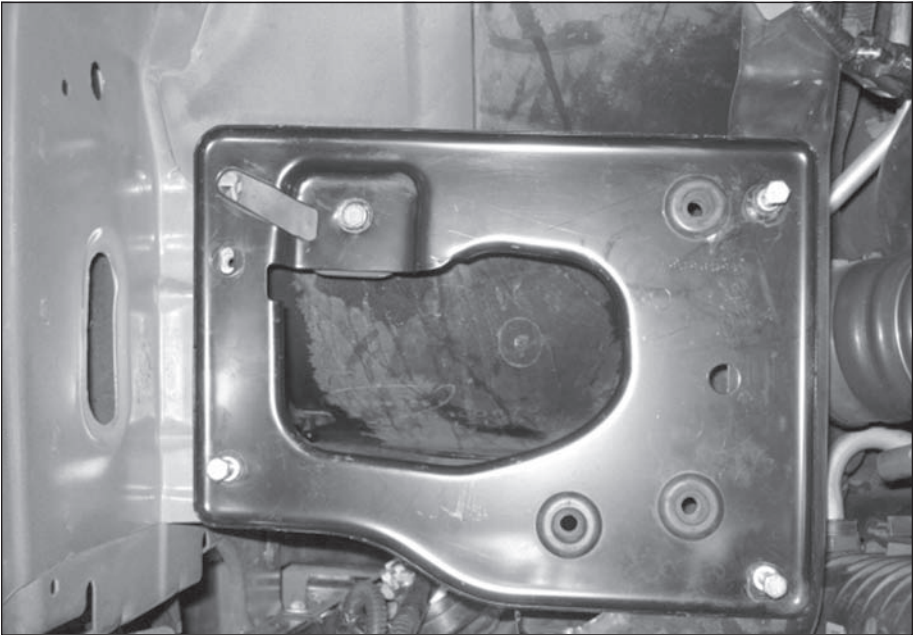

Figure 12 Air box support bracket

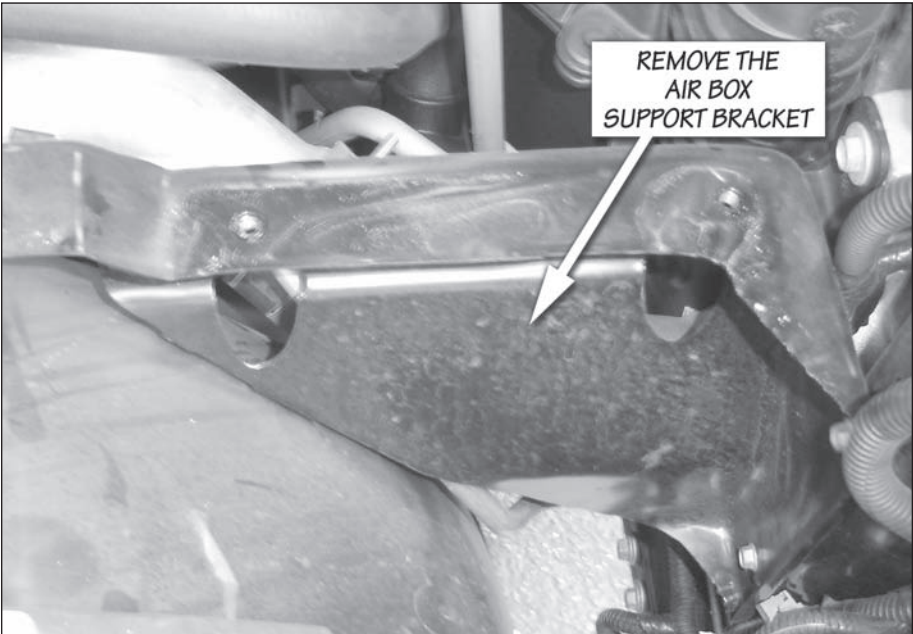
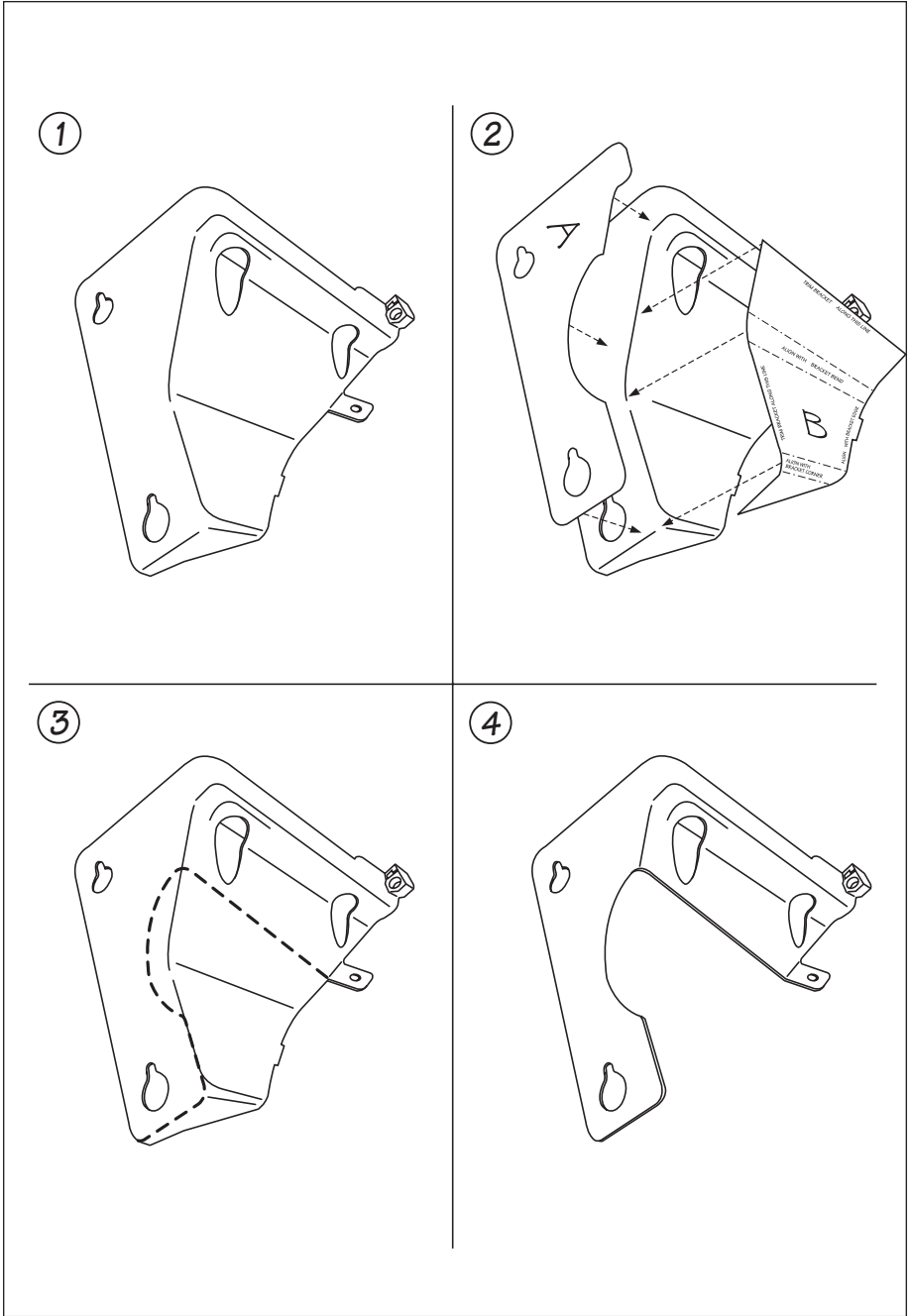

Figure 15



21. Remove the air box support bracket shown in **Figure 12**. There is an a/c condenser line retaining clip and a plastic fastener that attaches to the inner fenderwell that must be removed before the bracket can be liberated from the vehicle.

22. Trim the air box support bracket per the template in **Figure 13** and **Figure 14**. **Figure 15** shows the bracket before and after trimming.

NOTE: Paint trimmed edge to protect from rust.

23. Loosen the driver side boost tube hose clamps. Remove the boost tube off the charge air cooler (CAC). Do not damage the hoses that attach to the charge air cooler (CAC) as it will be reused. Cover the hose opening to prevent foreign debris from entering. See **Figure 16**.

24. Remove the passenger side boost tube hose. Use a hook or small screwdriver to remove wire-retaining clip. Remove the lower then the upper wire-retaining clip. Use a prying device to detach lower coupling hose connection. Pull off by twisting upper (hose coupler). Cover the intake manifold and turbocharger discharge to prevent foreign debris from entering during the installation. See **Figure 17** and **Figure 18**.

25. Remove the radiator attachment bolts. There are four 13mm socket bolts securing the radiator.

26. Lift the radiator out of it's lower saddle mounts and position it towards the engine so that it is no longer attached to the charge air cooler. Take care not to damage the radiator cooling fins.

Figure 16 Drivers side boost hose

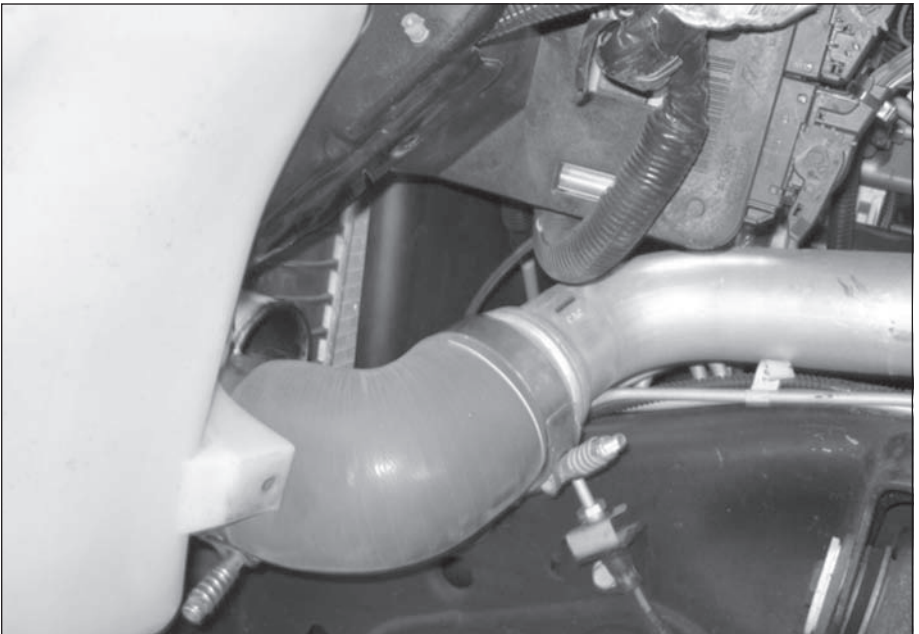

Figure 17 Passenger side boost tube



Figure 18 Passenger side boost tube



27. Remove the charge air cooler from the vehicle. Check that the lower mounting peg grommets are removed from the stock intercooler and place to the side. The lower rubber grommet will be transferred to the Banks intercooler in the next step.

INSTALL BANKS TECHNI-COOLER

28. Locate the supplied Banks charge air cooler and transfer both top and bottom rubber grommets and corresponding metal sleeve into position on the Banks charge air cooler.

29. Install the Banks CAC into the vehicle. Align the lower CAC mounting pegs with the rubber mounts in the vehicle's frame. There is a significant amount of play in the rubber mounts that can allow them to be aligned with the CAC as required.

30. Reinstall the radiator cross brace. Leave the attachment bolts loose to aid in aligning the CAC with the support.

31. Reinstall the radiator onto CAC. Secure the radiator to the Banks CAC with $\frac{5}{16}$ "-18 by $1\frac{1}{8}$ long bolts and large OD washers supplied in the Banks system. Tighten to 10-12 ft-lbs.

NOTE: Install the top two bolts 1st then install bottom two bolts. It may be helpful to use a pry bar or similar to assist in aligning the screw holes between the radiator and the Banks charge air cooler.

32. Install the upper CAC attachment bolts that were previously removed. There is enough play in the lower mounting pads, that the CAC can be positioned to align with the upper cross brace. Tighten the bolts.

33. Check that the engine-cooling fan can freely spin without contacting the lower fan shroud. If the fan contacts

the shroud, the shroud must be realigned with the radiator.

34. Tighten the 6 radiator-cross brace bolts to 80 in-lbs. Install the diagonal fender support brace and tighten the bolts.

35. Install the upper fan shroud. The push-in retainers that secure the upper shroud to the lower shroud are secured by inserting the retainer with the center pin pulled out. Once the retainer is inserted, press the center pin down to secure the retainer. Install and upper fan shroud bolts. The stock upper fan shroud bolts are reused and should be tighten to 80 in-lbs.

36. Install the transmission control module to the upper fan shroud.

37. Install the a/c condenser and tighten it's upper mounting bolts to 80 in-lbs.

38. Install the latch support. Tighten it's six attachment bolts to 80 in-lbs.

39. Install the hood latch. Position it so that it aligns with the marks that were previously made on the latch support prior to it's removal. Tighten it's bolts to 80 in-lbs.

40. Install the driver and passenger side plastic headlamp support structures. Tighten the screws to 80 in-lbs.

41. Install the light bulbs into the park/turn signal lamp assemblies. These are held in place by turning them clockwise. Install the park/turn signal lamp assembly onto the vehicle for both the driver and passenger side.

42. Install the electrical connectors to the headlamp assembly. Install the headlamp assemblies and secure them with their retaining pins.

43. Install the grill by snapping in the tabs into the retainer clips.

44. Install the upper grill baffle and secure with the seven push-in retainers that were previously removed. The push-in retainers that secure the grill baffle are secured by inserting the retainer with the center pin pulled out. Once the retainer is inserted, press the center pin down to secure the retainer.

45. Install the driver and passenger side boost tubes. Tighten the driver side hose clamps to 75 in-lbs. Make sure when reinstalling the passenger side boost tube that the hose coupler fits tight and flush to its respective mounting location, then reinstall the wire retaining clip.

NOTE: Before slipping any boost tubes and the corresponding hoses, into position, ensure that all connection ends are clean and free of any oil residue and contaminates. Clean compressor outlet and all connection points with a non-oil based solvent such as Acetone, Mineral Spirits, Denatured Alcohol or Lacquer Thinner. Read and follow the manufactures operation instruction for non-oil based solvent cleaner.

NOTE: The a/c line that runs near the intake manifold will need to be bent

downward to provide clearance for the boost tube. The a/c line can be bent by placing a wooden block on the a/c line, then lightly tapping the block with a hammer.

46. Install the driver side and passenger side fenderwell. The charge air temperature before the CAC approaches 400°F at full load. So, take care to route wiring away from the driver side boost tube and re-install the factory wire retainers on the fenderwell cover.

47. Install the lower air cleaner support bracket. Tighten the bolts to 80 in-lbs. Install the air cleaner mounting tray. Tighten the bolts to 80-in-lbs.

48. Install the air box assembly on it's mounting tray. Install the air duct on the turbocharger inlet and tighten it's hose clamp.

49. Re-install the connector on the MAF sensor at the air box assembly

50. Re-connect the ground cables on both batteries

Gale Banks Engineering
546 Duggan Avenue • Azusa, ca 91702
(626) 969-9600 • Fax (626) 334-1743

Product Information & Sales: (888) 635-4565

bankspower.com