

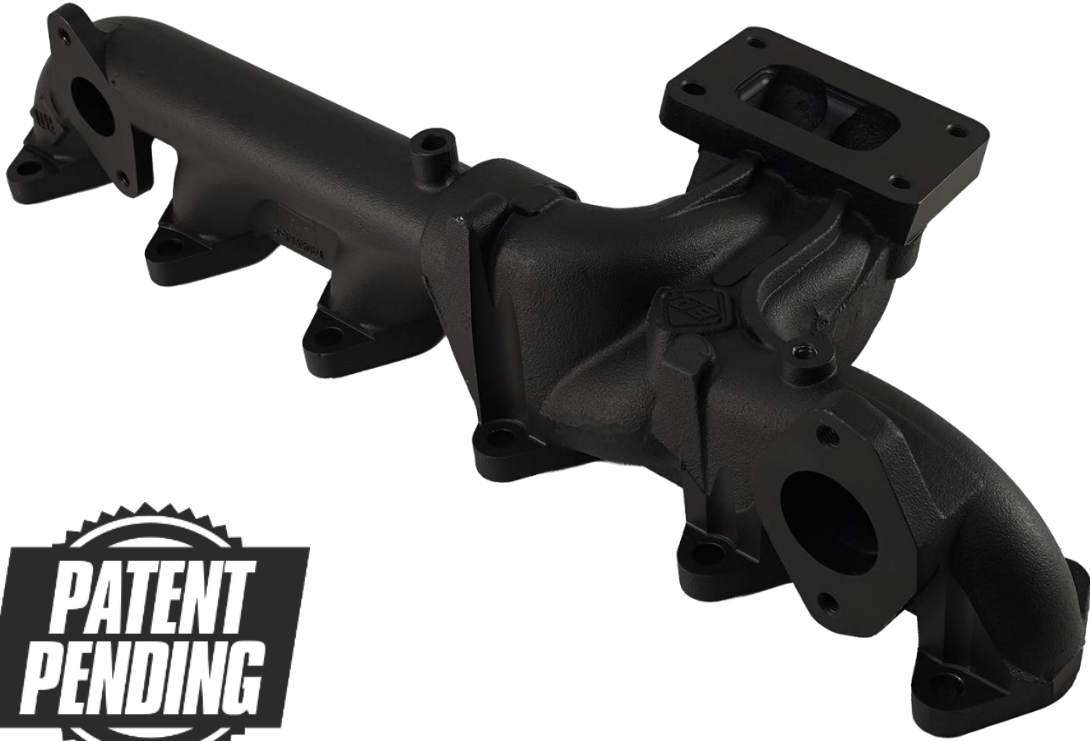

**DOWNLOAD COLOUR
INSTALL MANUALS AT
www.bddiesel.com**



Exhaust Manifold Kit

2019-2024 Ram Cummins 6.7L

1045969	2019-2024 Pickup
1045970	2019-2024 Cab & Chassis
1046069	2019-2024 Pickup Complete Kit
1046070	2019-2024 C&C Complete Kit

Please read all instructions before installation.

Table of Contents

Table of Contents.....2

Kit Contents2

Instructions6

 Airbox and Battery Removal6

 EGR Removal for Pickups9

 EGR Removal for Cab Chassis.....13

 Turbo Assembly Removal.....18

 Installation Preparation22

 Manifold and Turbo Installation23

 EGR Installation for Pickup25

 EGR Installation for Cab Chassis.....31





 Airbox and Battery Installation36

Kit Contents



Please check to make sure that you have all the parts listed in this kit before you start the disassembly of your truck.













1045969 Pickup Manifold		
1406069	1462430	
		
Pickup Manifold	Stud; M10-1.5 x 30mm	
Qty: 1	Qty: 3	
1200208	1462441	1462431
		
Plug; 1/8" NPT Hex	Nut; M10-1.5	Stud; M10-1.5 x 26mm
Qty: 1	Qty: 7	Qty: 4

1045970 Cab and Chassis Manifold				
1406070	1453149	1405971	FT-11115722	
				
Cab and Chassis Manifold	Fitting; 1/8 NPT to M12	Bracket; EBP Tube	M8-1.25 x 16	
Qty: 1	Qty: 1	Qty: 1	Qty:1	
1462430	1200208	1462441	1462431	1403106
				
Stud; M10-1.5x30	Plug; 1/8" NPT Hex	Nut; M10-1.5	Stud; M10-1.5 x 26	M8-1.25 x 20
Qty: 3	Qty: 1	Qty: 5	Qty:2	Qty.1

1046069 Complete Pickup Kit (Includes 1045969)			
1405900	1405902	4933225	
			
Manifold Gasket 6-Pack	Rear EGR Gasket	Front EGR Gasket	
Qty: 1	Qty: 1	Qty: 1	
1405937	FK-1045982		
			
Bolt Spacers	M10-1.5x60	M10-1.5x35	M10 Washer
Qty: 12	Qty: 12	Qty: 2	Qty:2

1045999 HE3XX 19+ Ram Turbo Kit				
4891288	5339363	68437471AA	1462441	
				
Oil Drain Gasket	Turbine Housing Gasket	Exhaust Outlet Elbow Gasket	Nut; M10-1.5	
Qty: 1	Qty: 1	Qty: 1	Qty: 1	
HE551-V80G2	1406853	1300131	3678603	1462430
				
Speed Sensor O-ring	Seal; Bonded 16.7mm	Cable Ties	Oil Feed Fitting O-ring	Stud; M10-1.5x30
Qty: 1	Qty: 4	Qty: 3	Qty: 1	Qty: 1
FT-920156020	FT-99604856	9464K19	1405788	
				
Oil Fitting Face O-ring	Oil Drain Tube O-ring	Coolant Fitting Face O-ring	Coolant Fitting O-ring	
Qty: 2	Qty: 2	Qty: 2	Qty: 1	

1046070 Complete Cab and Chassis Kit (Includes 1045970)	
1405900	1405904
	
Manifold Gasket 6-Pack	Rear EGR Gasket
Qty: 1	Qty: 1

1405937		FK-1045982		
				
Bolt Spacers		M10x60	M10x35	M10 Washer
Qty: 11		Qty: 12	Qty: 2	Qty: 2
1045999 HE3XX 19+ Ram Turbo Kit				
4891288	5339363	68437471AA	1462441	
				
Oil Drain Gasket	Turbine Housing Gasket	Exhaust Outlet Elbow Gasket	Nut; M10-1.5	
Qty: 1	Qty: 1	Qty: 1	Qty: 1	
HE551-V80G2	1406853	1300131	3678603	1462430
				
Speed Sensor O-ring	Seal; Bonded 16.7mm	Cable Ties	Oil Feed Fitting O-ring	Stud; M10-1.5x30
Qty: 1	Qty: 4	Qty: 3	Qty: 1	Qty: 1
FT-920156020	FT-99604856	9464K19	1405788	
				
Oil Fitting Face O-ring	Oil Drain Tube O-ring	Coolant Fitting Face O-ring	Coolant Fitting O-ring	
Qty: 2	Qty: 2	Qty: 2	Qty: 1	

Instructions

Before installation, drain the coolant and raise and secure vehicle on hoist.

Airbox and Battery Removal

1. Disconnect the Intelligent Battery Sensor (IBS) wire harness connector.
2. Disconnect and isolate both of the negative battery cables.

Important! IBS must be disconnected before battery cables to avoid damage!

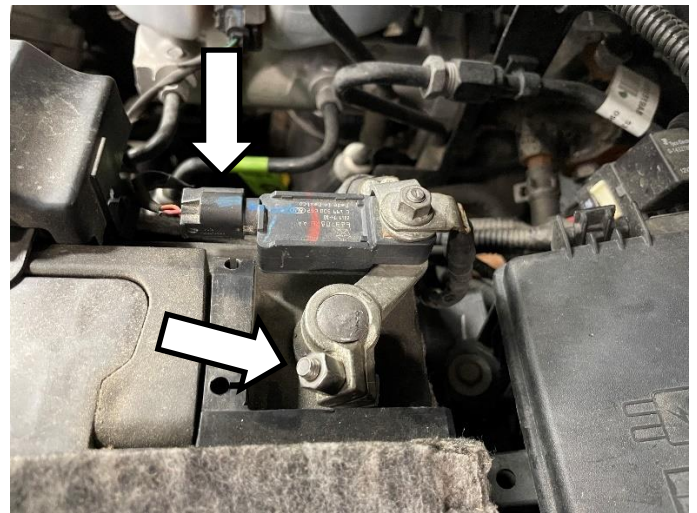

3. Disconnect the Mass Air Flow (MAF) sensor wire harness connector.
4. Disconnect the Temperature / Barometric Absolute Pressure (T/BAP) sensor wire harness connector.
5. Detach the wire harness from the air intake box.

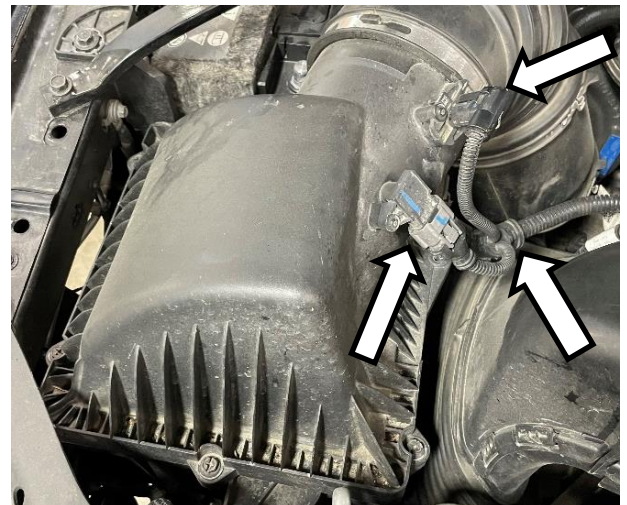

6. Loosen the clamp and remove the intake tube from turbocharger.
7. Loosen the clamp and remove the intake tube from the air cleaner.

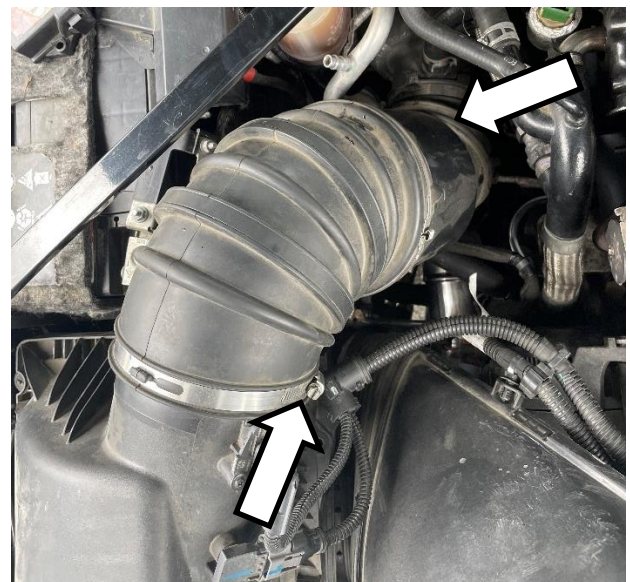

8. Spread the two locking tabs on the air inlet duct and separate the clean air duct from it.
9. Remove the air cleaner and intake tube assembly by lifting up on the air cleaner.

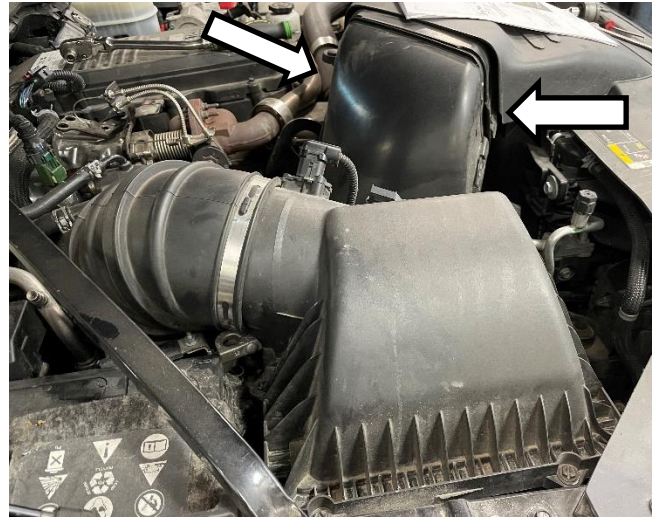

10. Remove the 4 bolts securing the engine cover.

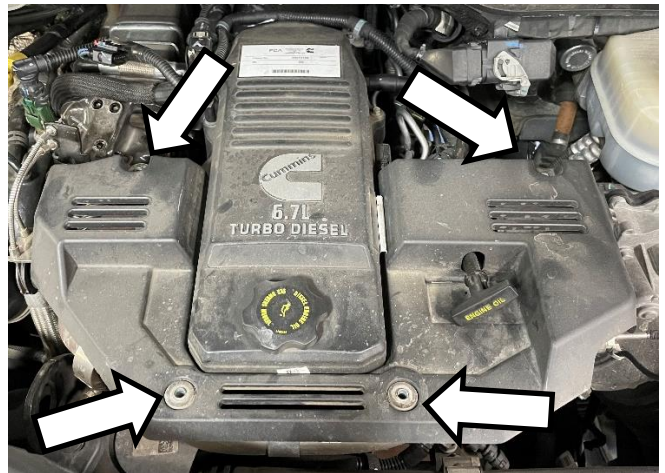

11. Remove the passenger side wheel and inner fender.



12. Remove passenger side reinforcement beam.
13. Remove the passenger side battery hold-down and remove the battery.



14. Remove the two fasteners that secure the heater relay and set aside.



15. Remove the 4 fasteners that secure the battery tray.

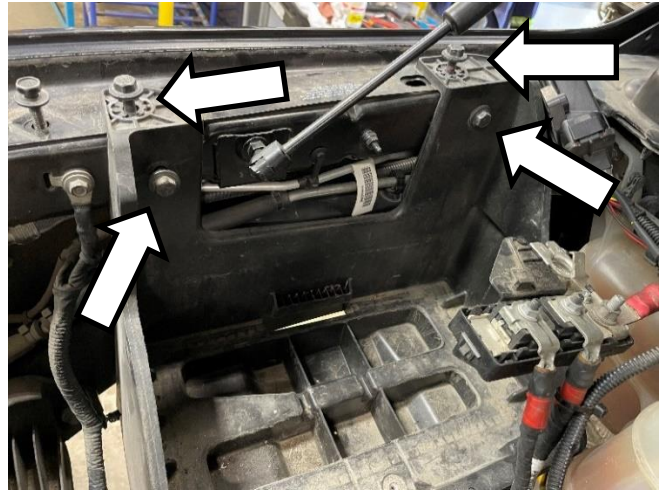

16. Remove the 2 fasteners that secure the bottom of the battery tray, then lift the battery tray out of the engine compartment and remove it from the vehicle.

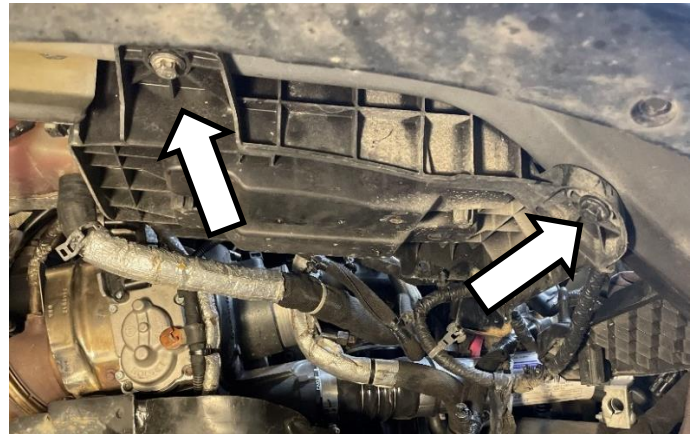

EGR Removal for Pickups

Skip to page 13 for cabin chassis EGR removal.

1. Remove the heater hose, vent hose and turbocharger return coolant line from EGR cooler outlet tube.
2. Remove the upper mounting bolt and disconnect the front EGR cooler outlet tube from water inlet connection by gently pulling it off the outlet.

Note: EGR outlet plastic collar does not need to be removed for disassembly.

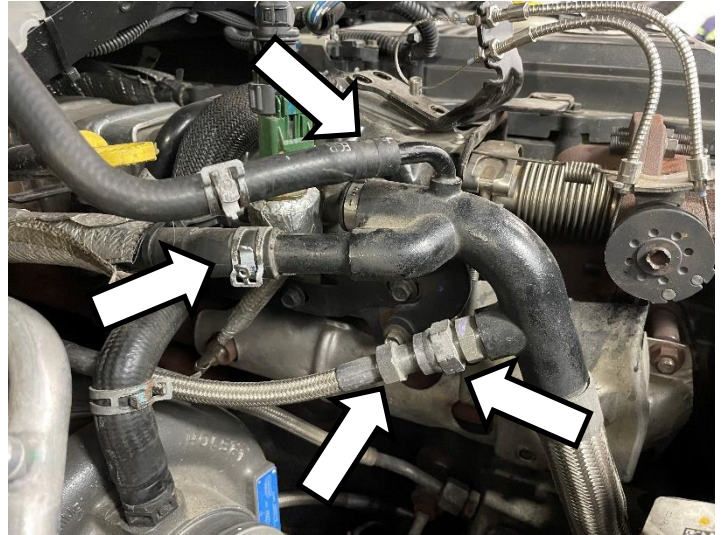

3. Remove the coolant bottle hose from the EGR coolant outlet tube.
4. Remove the lower mounting bolt and remove the EGR cooler outlet tube.
5. Remove the oil feed line.

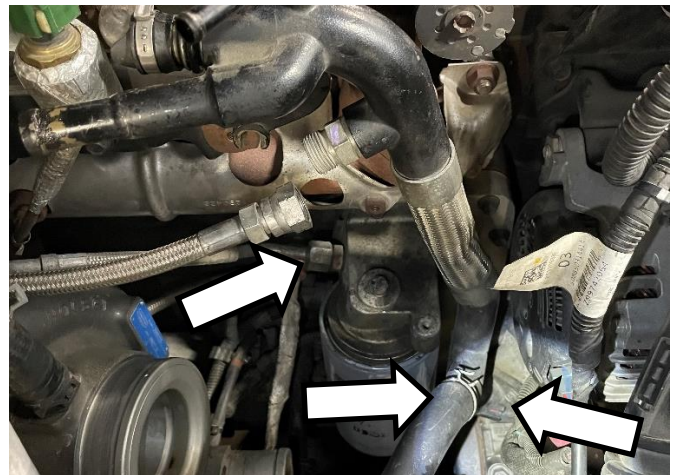

6. Remove the oil feed and coolant return lines from the turbocharger.

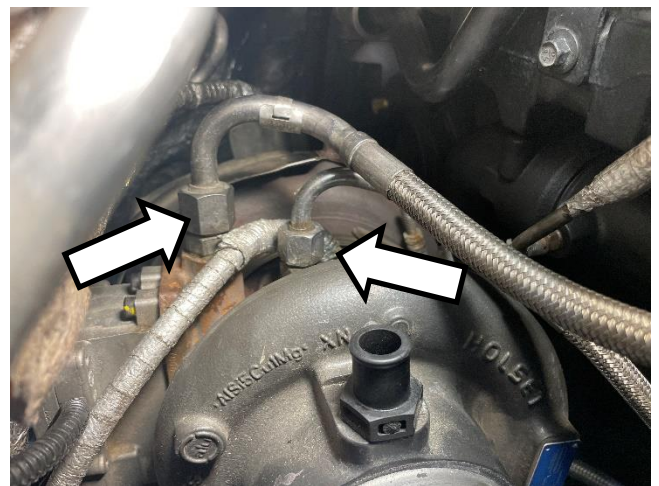

7. Remove EGR lower heat shield.

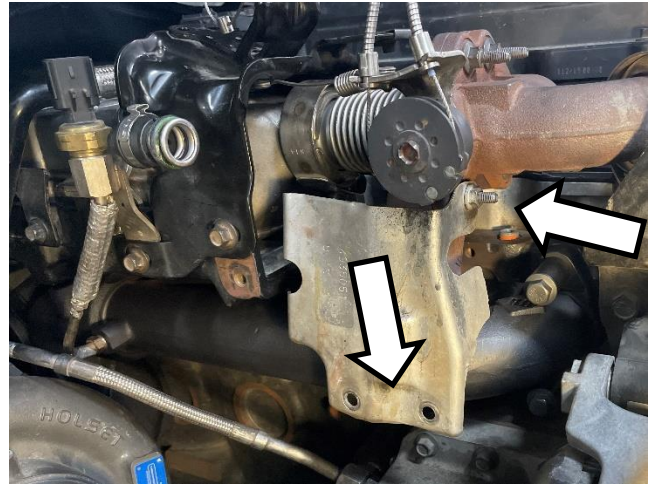

8. Remove upper EGR heat shield.

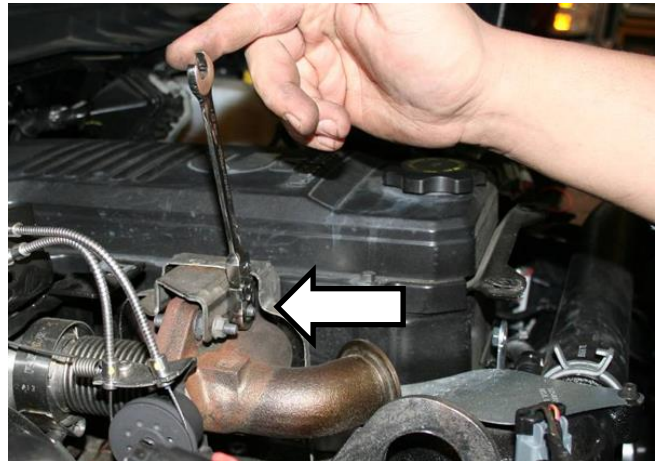

9. Disconnect EGR servo motor connector.



10. Remove the breather hose from the Closed Crankcase Ventilation (CCV) cover and turbocharger.

11. Disconnect exhaust back pressure sensor connector.

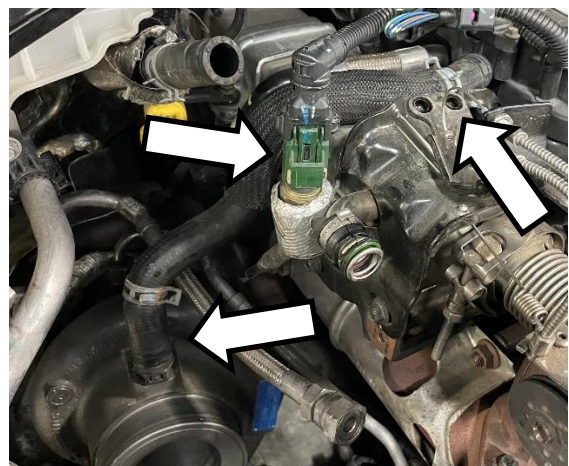

12. Remove the rear coolant tube outer bolt and remove the tube from EGR cooler by gently pulling it off.

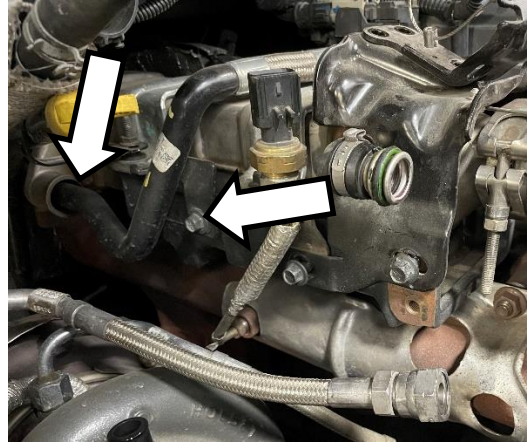

13. Remove the rear coolant tube inner bolt and remove the tube from the engine.

Note: Tube can be removed without removing CCV cover, pull tube off toward passenger side of vehicle.



14. Remove the 4 servo mounting bracket bolts and prop the bracket up on the cooler.

Note: Servo motor removed for clarity.

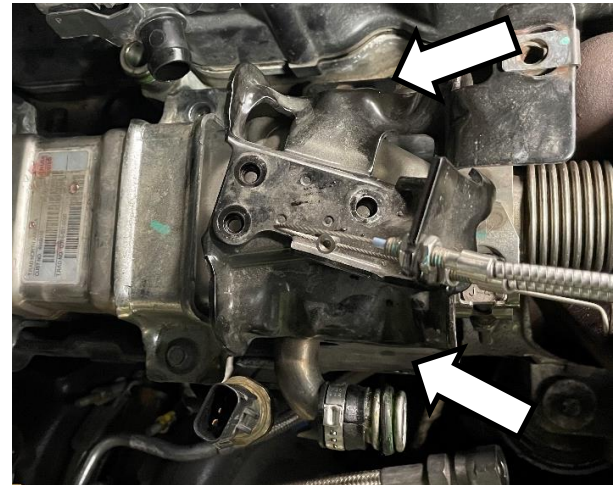

15. Remove the EGR expansion joint clamp.

16. For 68RFE only, remove the transmission dipstick hold down nut.

17. Disconnect the exhaust back pressure sensor tube from the manifold and remove.

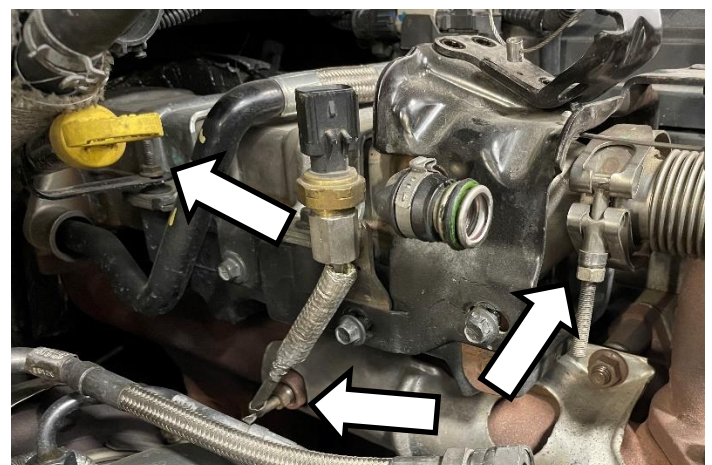

18. Remove the EGR cooler nuts (1).

19. Remove the 3 EGR cooler mount bolts (3) and the EGR cooler.

20. Remove EGR cooler and discard the flange gasket.

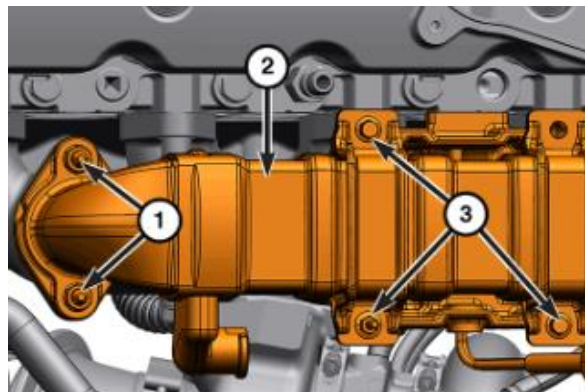

21. Remove the bolts and the EGR cooler mounting bracket.

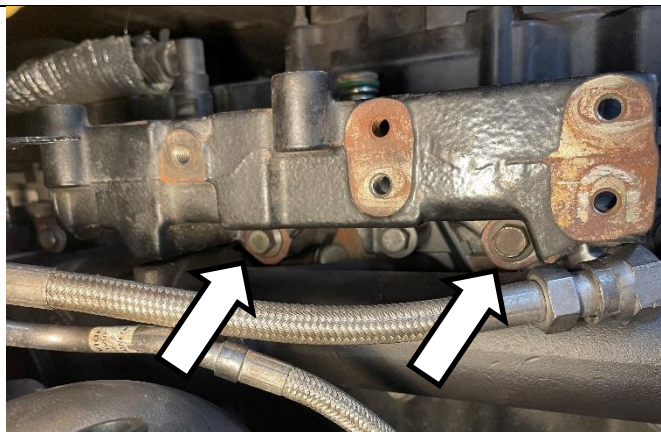

22. Remove the passenger side EGR transfer tube clamp.

23. Remove the 2 nuts that secure the transfer manifold.

24. Remove the bypass valve, transfer manifold and servo motor assembly together.

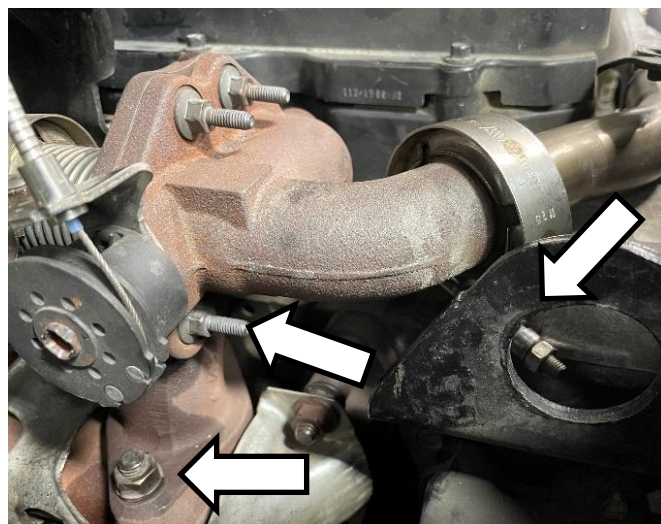

EGR Removal for Cab Chassis

1. Disconnect the coolant bottle hose (1).
2. Remove the banjo bolt securing the coolant hose (2).
3. Remove the coolant hose (3).
4. Remove the turbocharger coolant return tube union nut (4) from the coolant outlet tube, and position turbocharger coolant return tube to the side.

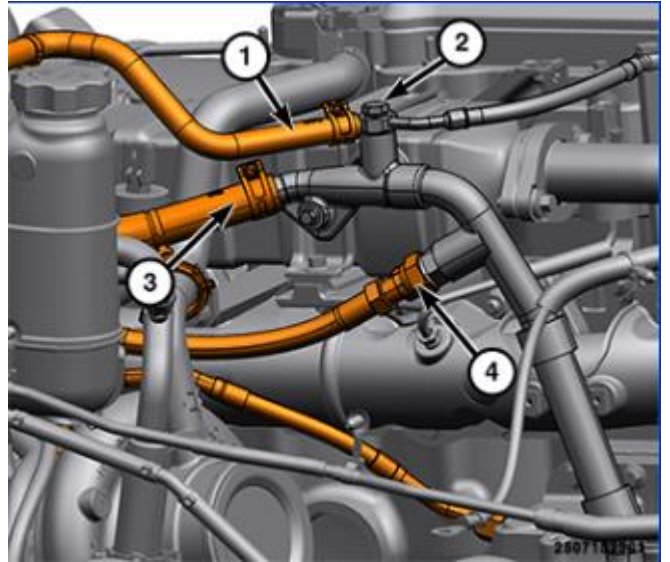

5. Remove the bolts, and the coolant outlet tube.

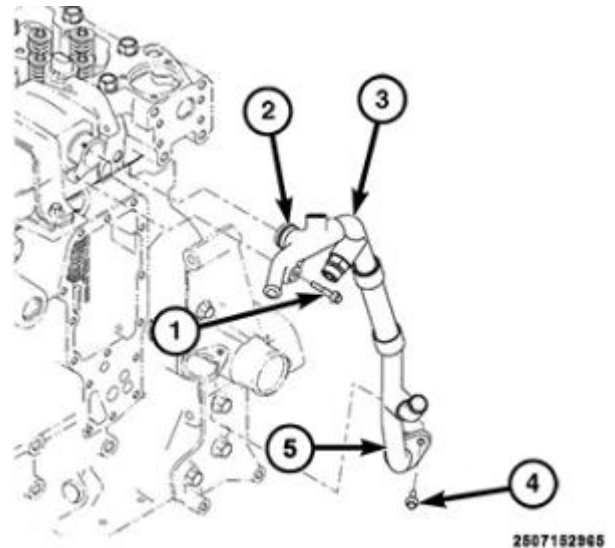

6. Remove the bolt (1), and the rear coolant inlet tube (2).

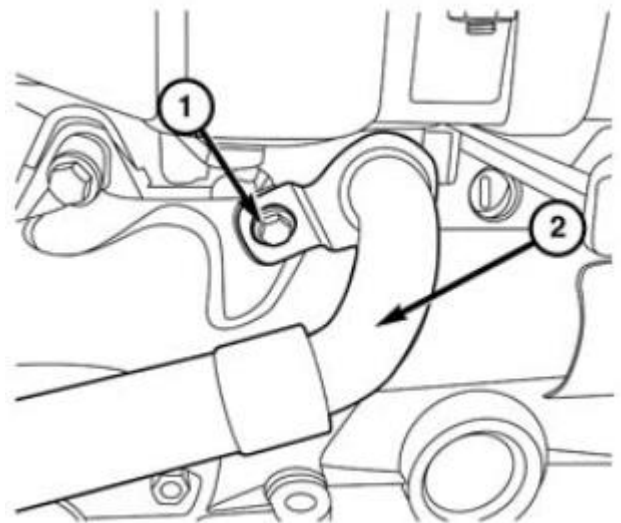

7. Remove the bolt and the rear EGR cooler inlet tube.

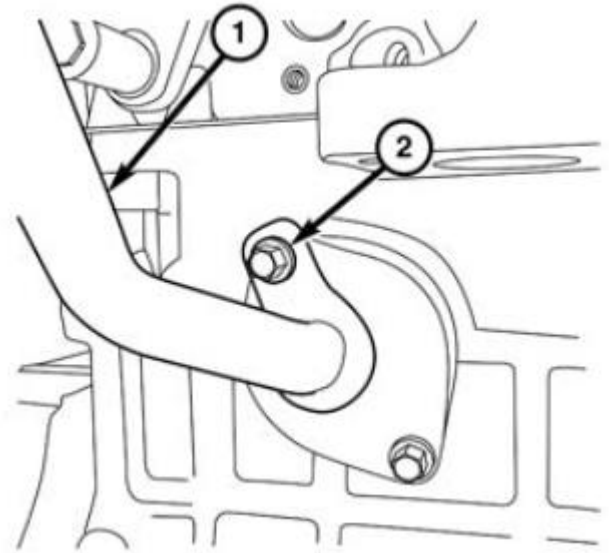

8. Disconnect the EGR temperature sensor harness connector (1).

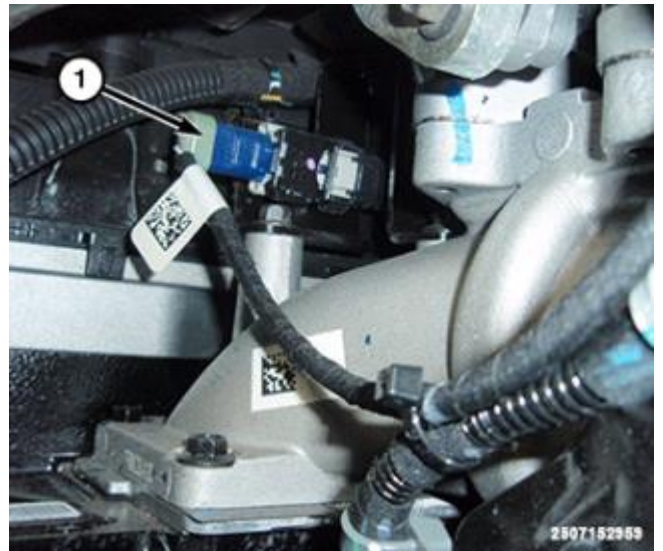

9. Cut the cable ties securing the wire harness retainers (2).

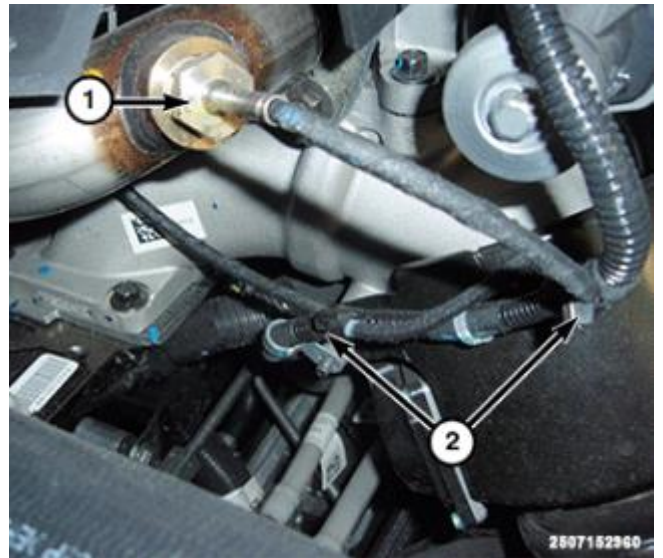

10. Remove the EGR tube support bracket bolt (1).

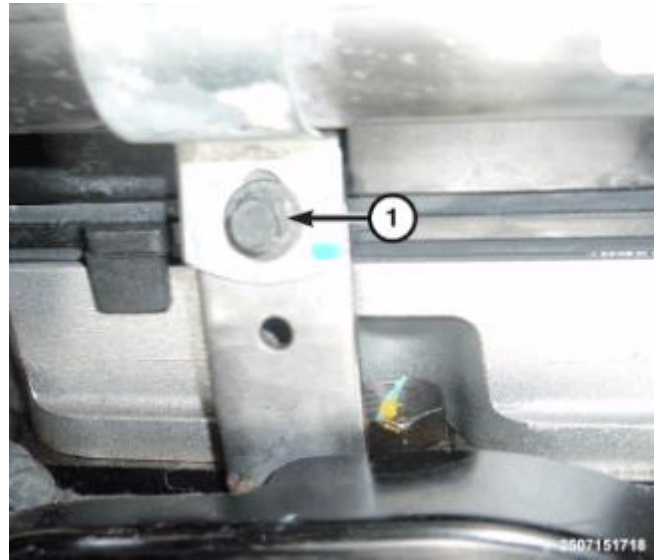

11. Remove the EGR crossover tube bolts on the EGR valve side (3).

12. Remove EGR crossover tube bolts on the EGR cooler side (1).

13. Remove EGR crossover tube and seals at each end (2). Reuse seals if undamaged.

14. If necessary, remove the EGR temperature sensor.

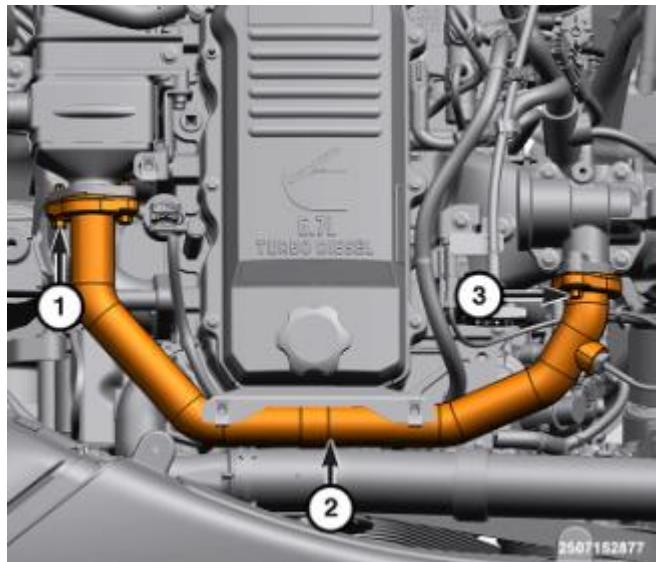

15. Remove the EGR cooler mount bolts.

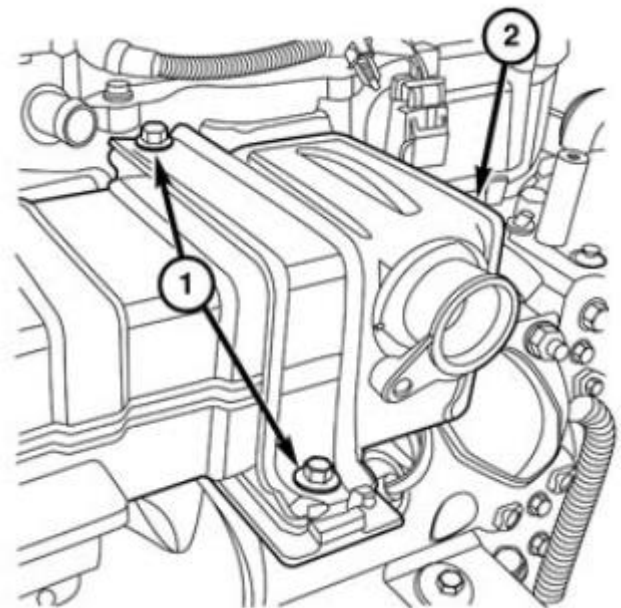

16. Remove nuts and the EGR cooler.

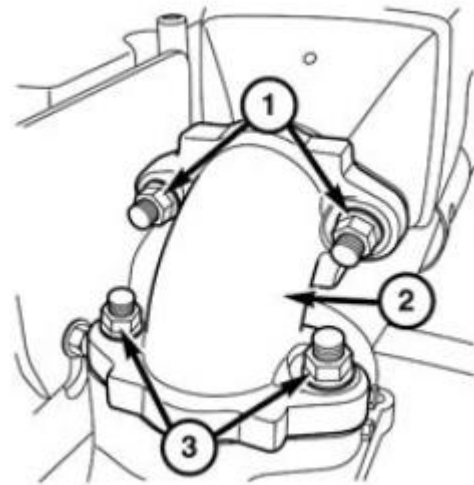

17. Remove the exhaust manifold flange gasket.

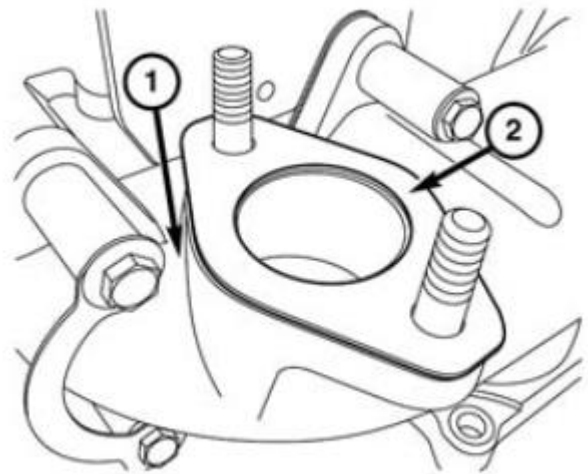

18. Disconnect the front exhaust pressure sensor wire harness connector (1).

19. Remove the front exhaust pressure sensor heat shield (2).

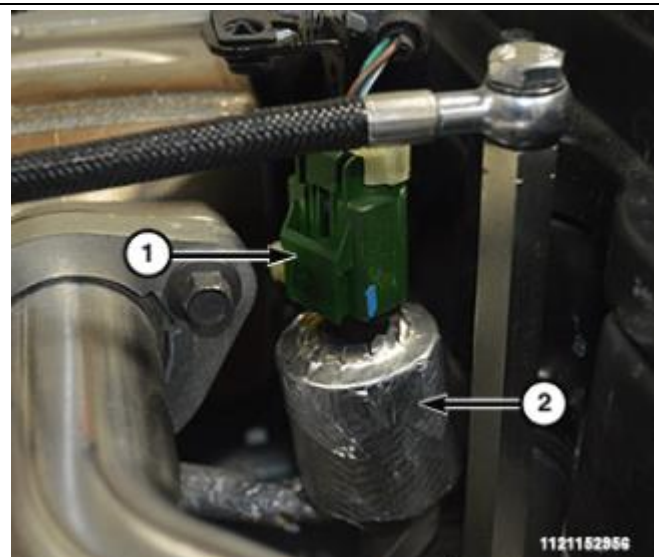

20. Remove the front exhaust pressure sensor.

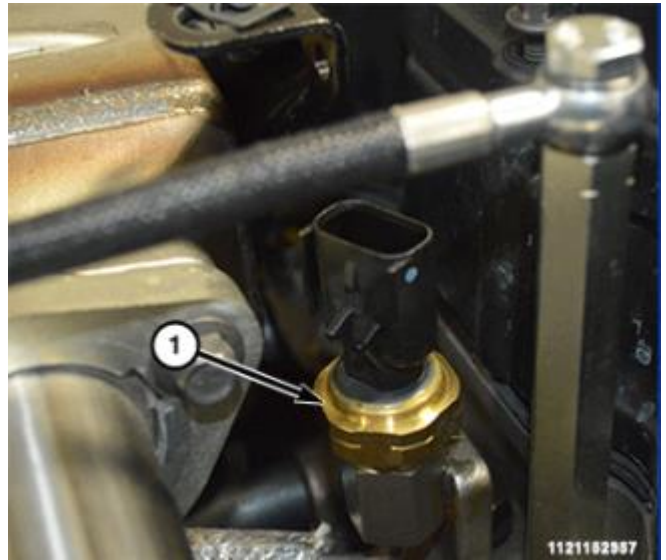

21. Remove the bolt securing the front exhaust pressure sensor tube to the EGR cooler bracket.
22. Unscrew fitting and remove the front exhaust pressure sensor tube.

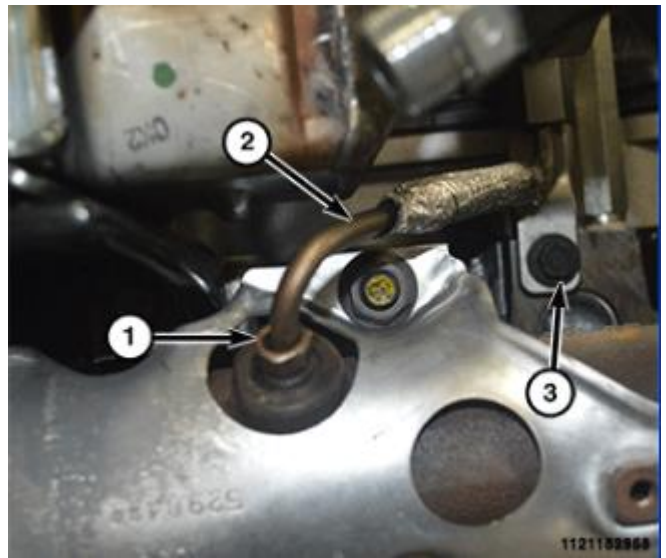

23. Disconnect rear exhaust pressure sensor wire harness connector (1).

24. Remove the rear exhaust pressure sensor heat shield (2).

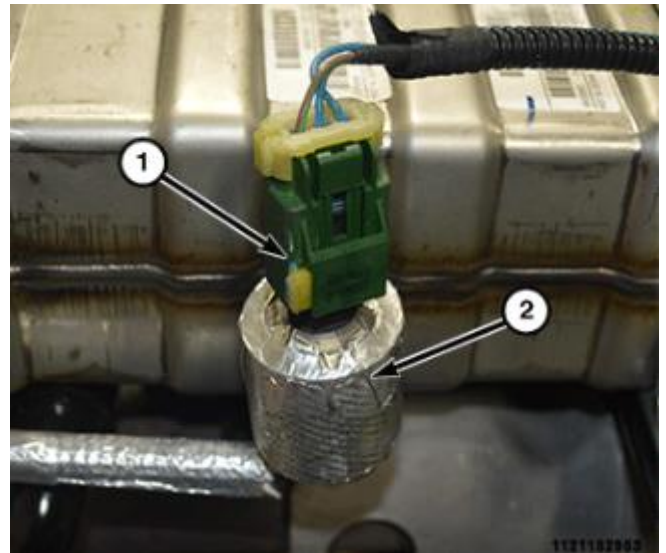

25. Remove the rear exhaust pressure sensor.

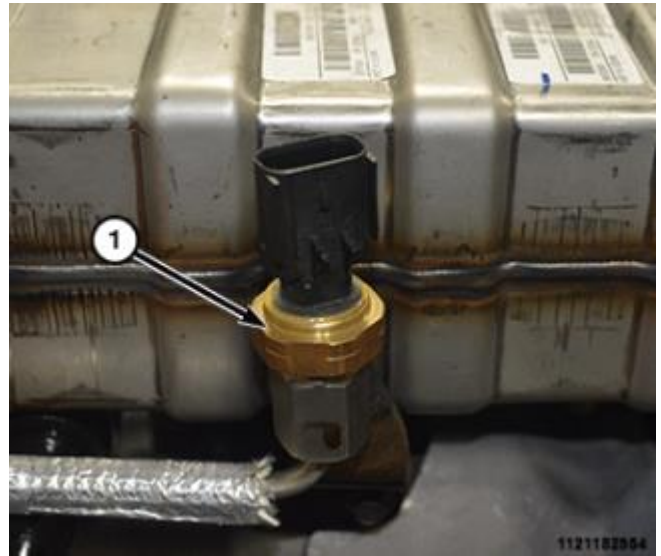

26. Remove the bolt and the nut securing the exhaust pressure sensor tube (3) (4).
27. Unscrew fitting (1) and remove the exhaust pressure sensor tube (2).

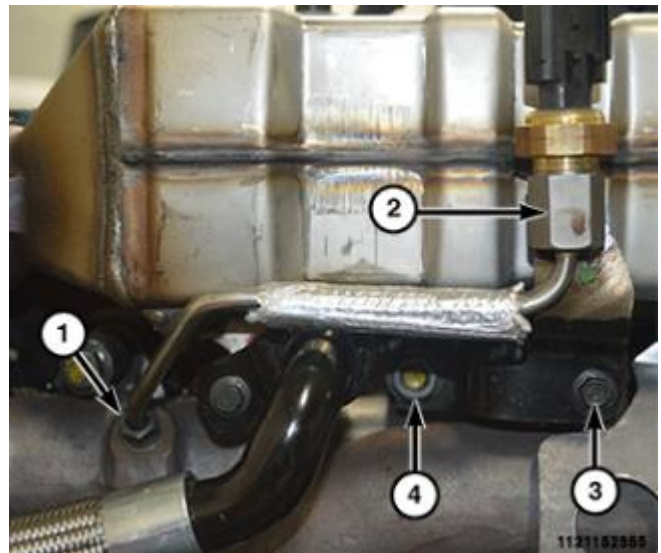

Turbo Assembly Removal

1. Loosen clamps at the turbocharger compressor inlet and breather cover, and remove the breather hose.

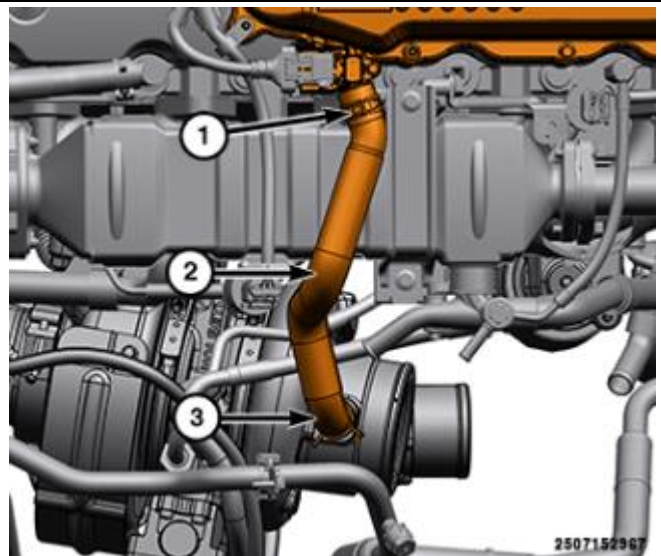

2. Remove the right CAC tube.

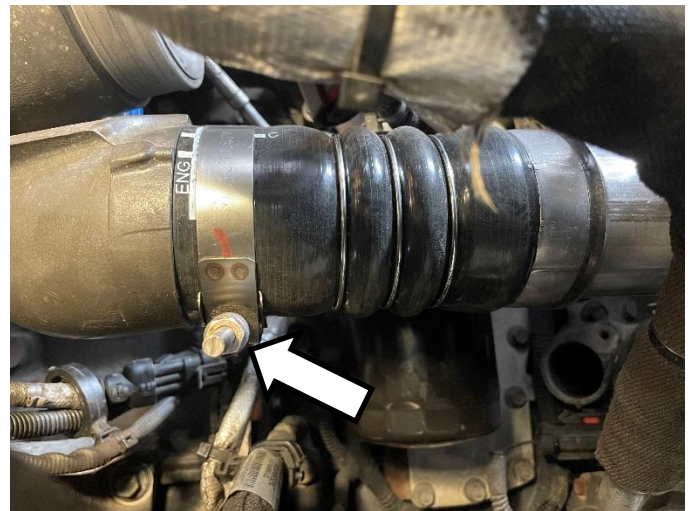

3. Cut the cable ties (1, 2) securing the NOx sensor wire harness, actuator harness, and turbo speed sensor harness.

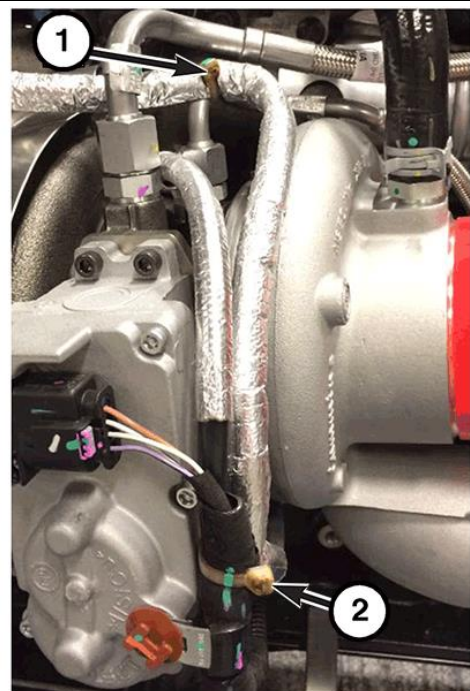

4. Cut the cable tie (1) securing the NOx sensor harness, actuator wire harness and turbo speed sensor harness to the oil drain tube.
5. Carefully separate the clip (2) securing the speed sensor harness connector.
6. Disconnect the speed sensor harness connector (4).

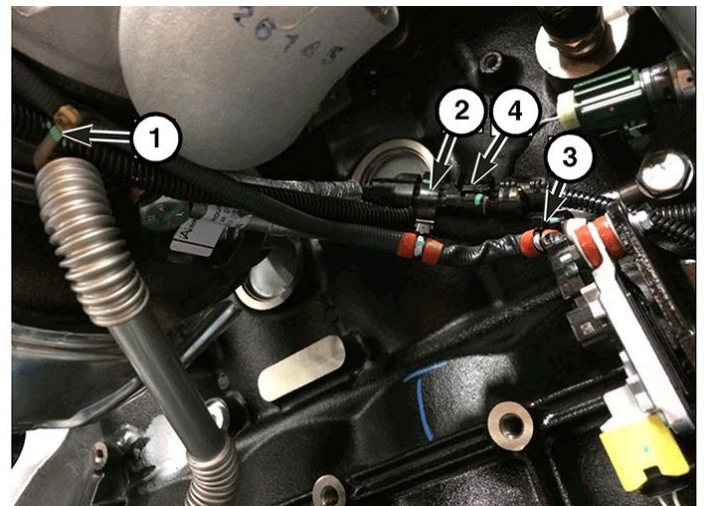

7. Remove the plastic clip (2) securing harness to actuator.
8. Disconnect actuator harness connector (1) by cleaning the connector to remove debris, pulling the light gray release lever away from the locked position with your thumb nail until it clicks into the unlocked position, then holding the light grey release lever down while pulling the connector apart.

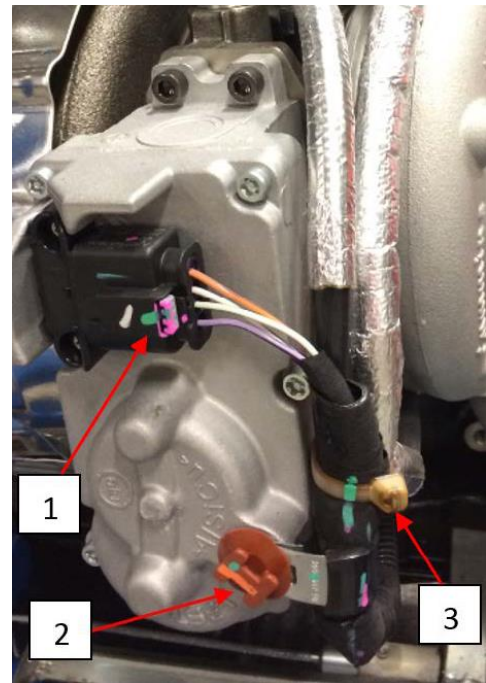

9. Remove the bolts and the oil drain tube from the turbocharger.
10. Remove the banjo bolts and the coolant supply tube.

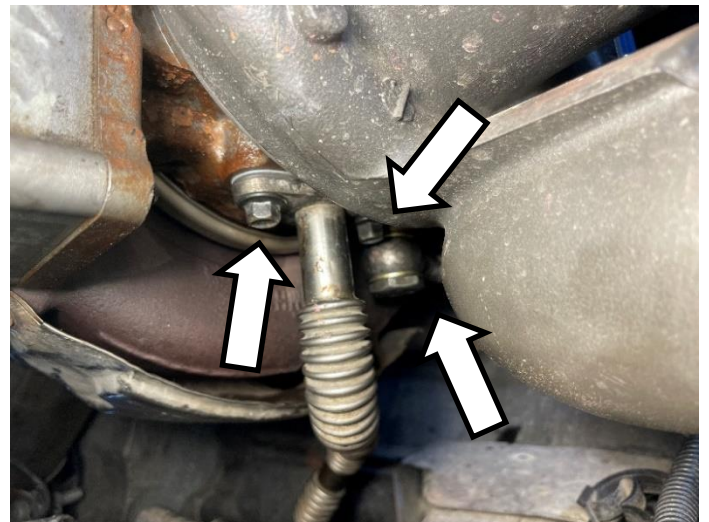

11. Remove both band clamps from the exhaust outlet connector elbow, and then reposition the elbow out of the way.

Note: The NOx sensor does not need to be removed for this step.

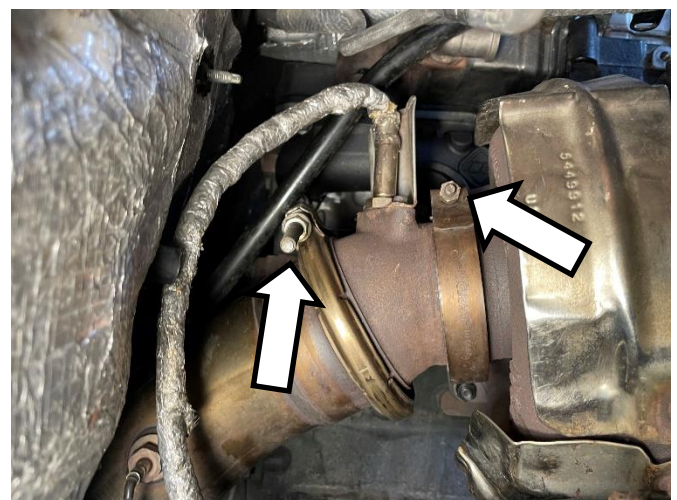

12. Remove the right-side turbocharger to exhaust manifold nuts.

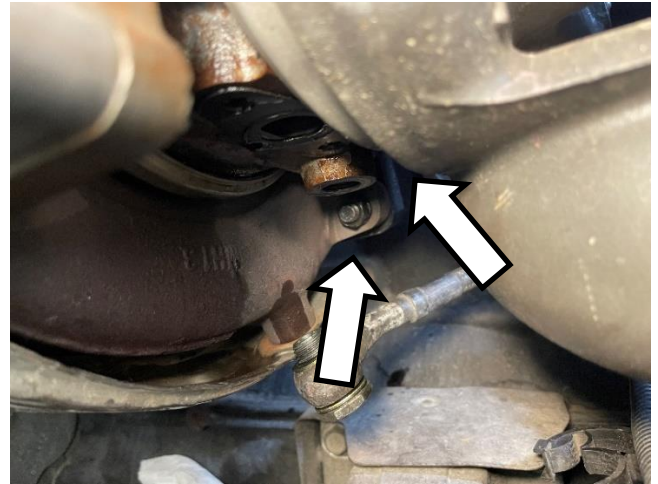

13. Remove the left side turbocharger to exhaust manifold nuts and remove the turbocharger from the vehicle.

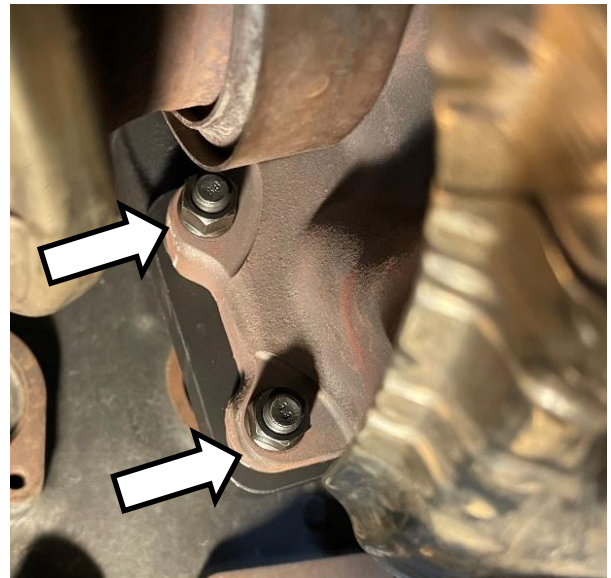

14. Remove the nuts (1) and the exhaust manifold heat shield (3).

15. Remove the rear exhaust manifold bolt lock plate (4) and discard.

16. Remove the exhaust manifold bolts (5,6) and spacers (2) and remove the manifold from the vehicle.

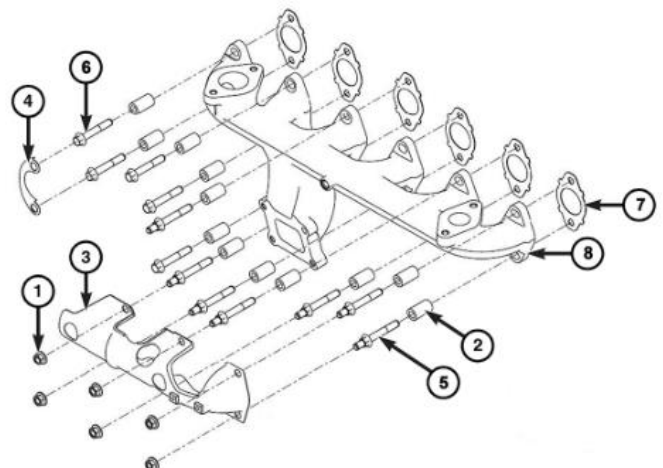

Note: For cab chassis only, keep one of the heat shield exhaust manifold bolt, nut, and spacer which will be used for EBP tube bracket installation.



Installation Preparation

1. Clean the cylinder head exhaust port gasket surfaces and the mounting flange on the turbocharger.
2. Install three of the included studs in the flange for the turbocharger and two studs on each EGR port. Torque studs to **24 Nm (18 ft-lbs)**.



3. Install the 1/8" NPT plug on the rear manifold section if not using with pyrometer probe. Torque plug to **0.79 Nm (7.0in-lbs)**.



Important! For the cab chassis, the EGR cooler bracket **MUST** be installed prior to the installation of the manifold. The EGR bracket will not slide into position if this is not done. Tighten the EGR cooler mounting bracket to cylinder head bolts to **36 Nm (27 ft-lbs)**.



Manifold and Turbo Installation

1. Install the exhaust manifold and gasket and secure. Starting with cylinder No. 4 upper bolt hole, tighten the nuts finger tight. Tighten the nuts from the center of the manifold out to **53 N·m (39 ft. lbs.)**. Re-tighten the four center nuts to **53 N·m (39 ft. lbs.)**.

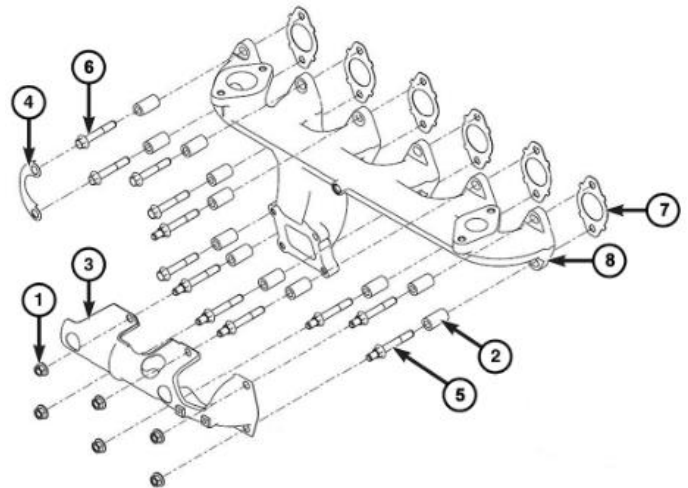

2. Install the turbocharger and turbo gasket onto the exhaust manifold studs by coming through the wheel well, and tighten with the supplied nuts finger tight.
3. Torque the nuts to **43 Nm (32ft-lbs)** using a cross pattern.

Important! Improper flange torque can lead to exhaust leak, gasket failure and flange damage.



4. Install gasket at the rear of the exhaust outlet connector elbow, correctly align the elbow and pipe, and then tighten the forward band clamp to **17 Nm (13 ft-lbs)**, and the rear clamp to **61 Nm (45 ft-lbs)**.



5. Lubricate the drain tube o-rings (2) with clean engine oil, and install the turbocharger drain tube (1) into the engine block.



6. Install the turbo oil drain tube with gasket and tighten the bolts to **24 Nm (18 ft-lbs)**.
7. Install the turbo coolant supply line and tighten the banjo bolts to **35 Nm (26 ft-lbs)**.

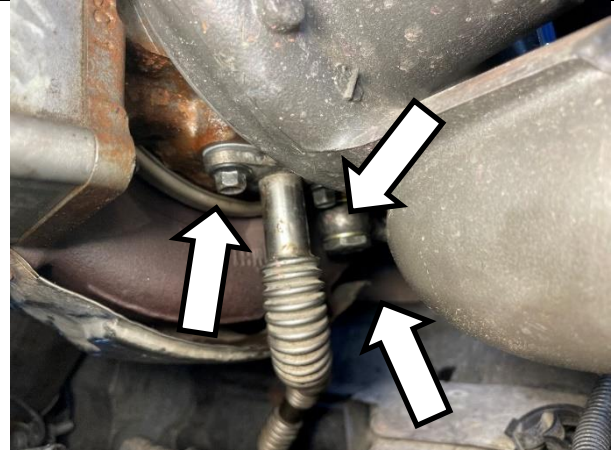

8. Install the turbo oil supply line and tighten the union nuts to **24 Nm (18 ft-lbs)**.
9. Install the coolant return line and tighten the union nut on the turbo to **35 Nm (26 ft-lbs)**.

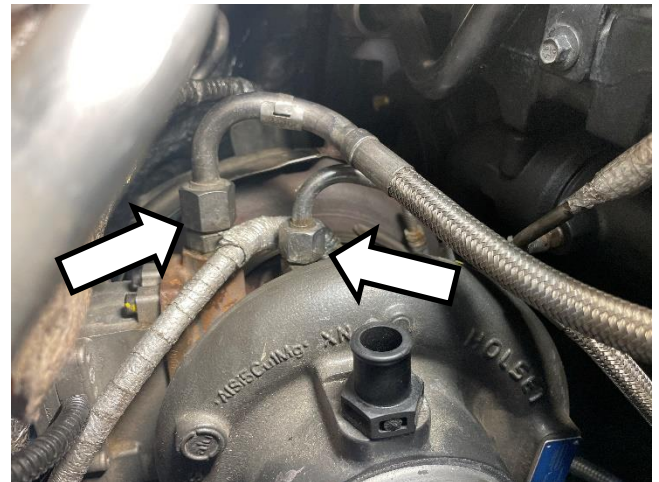

Note: Ensure there is sufficient clearance between the lines and other components.

10. Connect the turbo actuator harness connector (1).
11. Screw in the plastic clip (2) securing the turbo actuator wire harness.

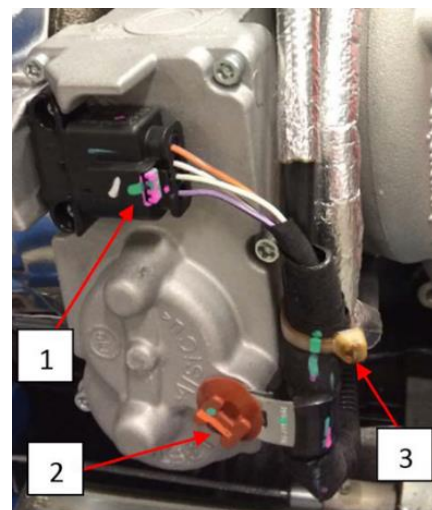

12. Connect the turbo speed sensor harness connector (4).
13. Attach clip (2) in its original location to secure the turbo speed sensor connector.
14. Install a cable tie to secure the NOx sensor wire harness, turbo actuator wire harness, and turbo speed sensor wire harness to the oil drain tube (1).

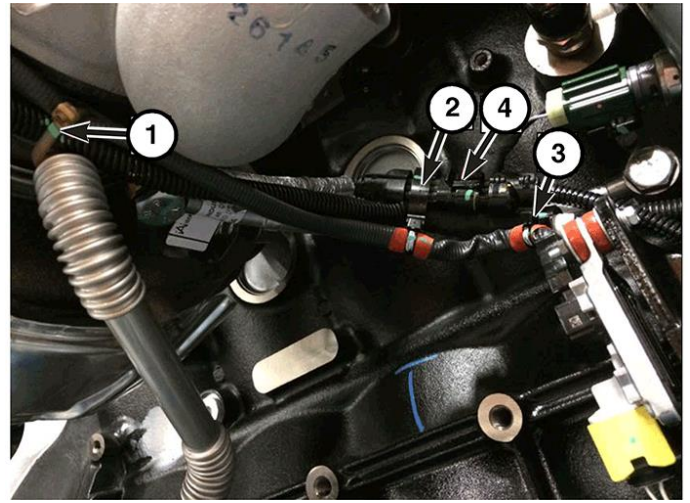

15. Use a cable tie to secure the NOx sensor harness, turbo actuator harness, and speed sensor harness (2).
16. Use a cable tie to secure the NOx sensor wire to the oil supply tube (1).



EGR Installation for Pickup

1. Install the bypass valve, transfer manifold and servo motor assembly together.
2. Install the exhaust transfer manifold and tighten the nuts to finger tight.
3. Install the passenger side EGR transfer tube clamp.

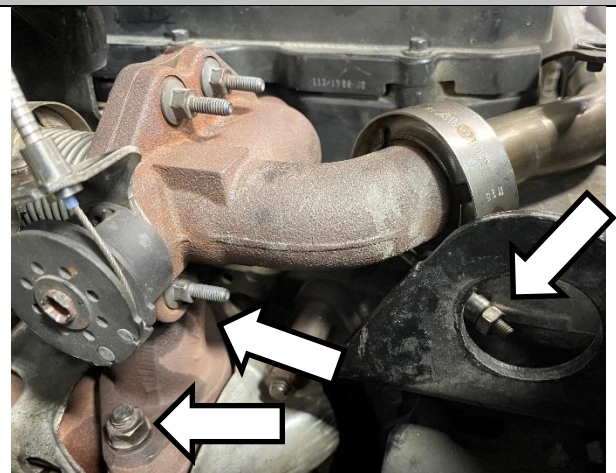

4. On the pickup, install the EGR cooler mounting bracket and bolts hand tight.

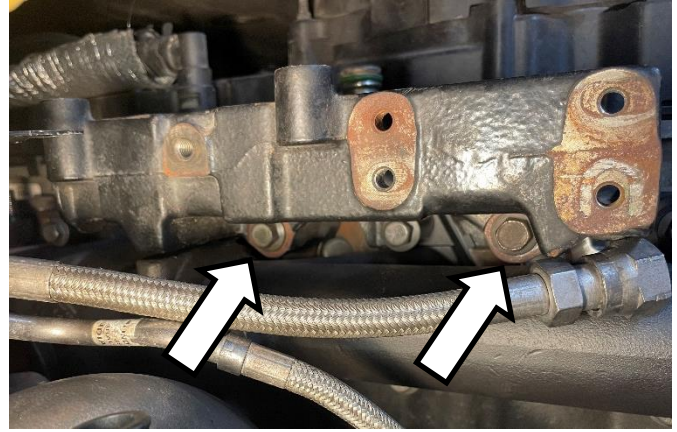

5. Install the EGR cooler and gasket on exhaust manifold flange and tighten the nuts finger tight.
6. Install the EGR cooler bolts finger tight.

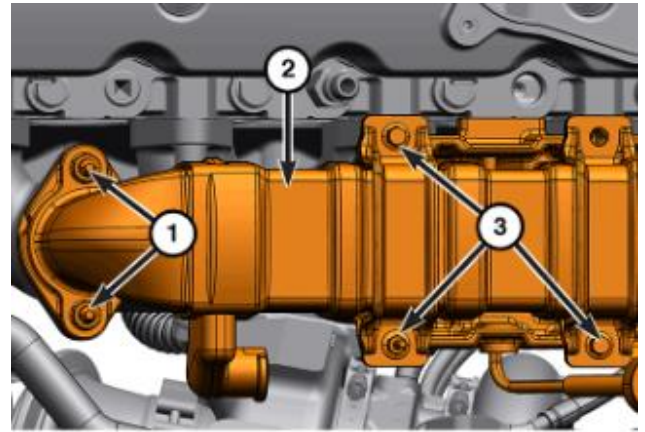

7. Tighten the EGR cooler inlet flange to the exhaust manifold nuts to **60 Nm (44 ft-lbs)**.
8. Using a crisscross pattern, tighten the EGR cooler bolts to **24 Nm (18 ft-lbs)**.

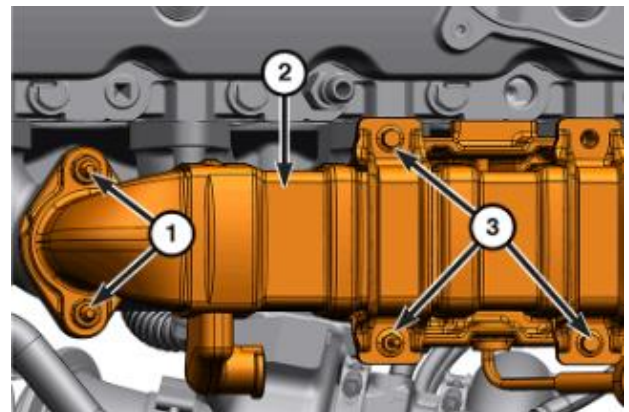

9. Tighten the nuts on the exhaust transfer manifold to **43 Nm (32 ft-lbs)**.
10. Install the clamp with gasket securing the EGR cooler to exhaust transfer manifold, making sure that the bellows pilot is lined up with the EGR cooler outlet. Tighten the clamp.

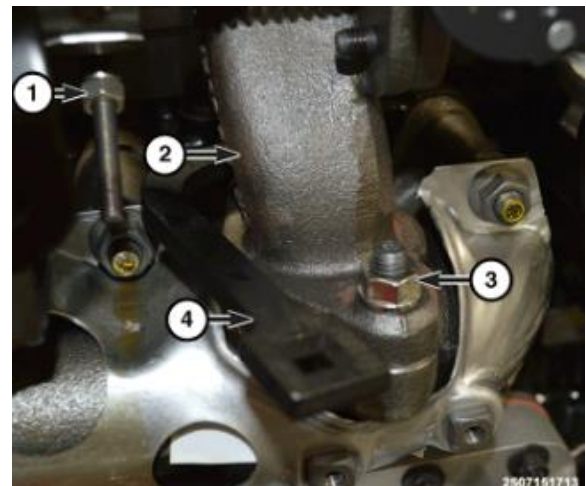

11. Connect the exhaust back pressure sensor tube to the manifold.

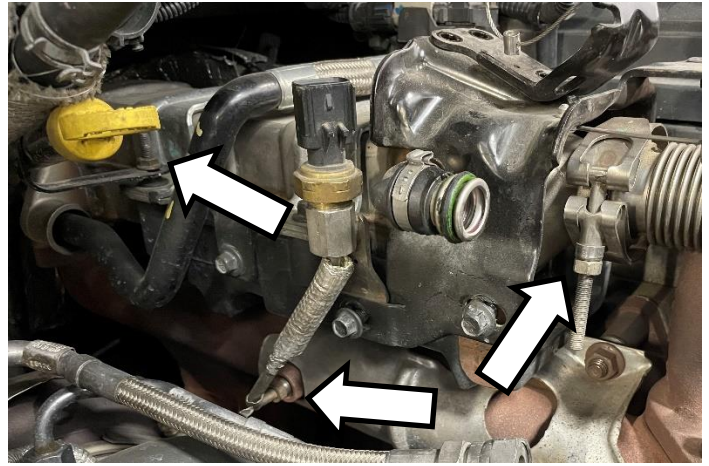

12. Install the servo mounting bracket.

Note: Ensure back pressure sensor is secured behind the servo bracket

13. Install the two inside bracket bolts and tighten to **10 Nm (89 in-lbs)**.
14. Install the two outside bracket bolts and tighten to **24 Nm (18 ft-lbs)**.

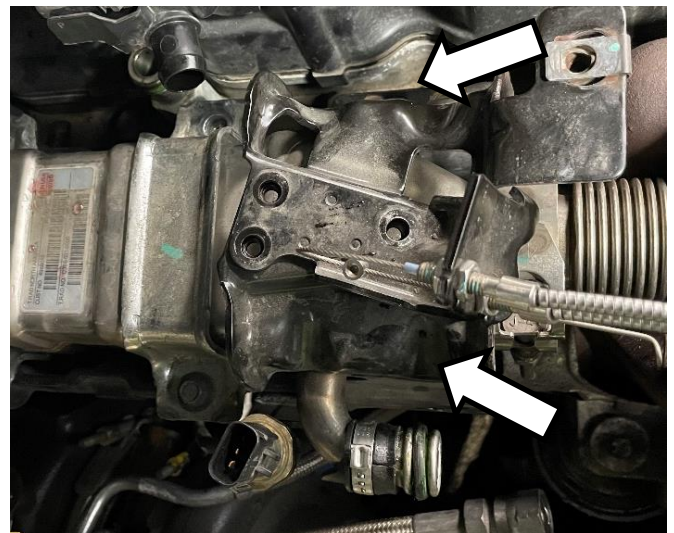

Note: Servo motor removed for clarity.

15. Install the rear coolant tube onto the inlet fitting.

NOTE: Lubricate the O-rings with coolant before installing.

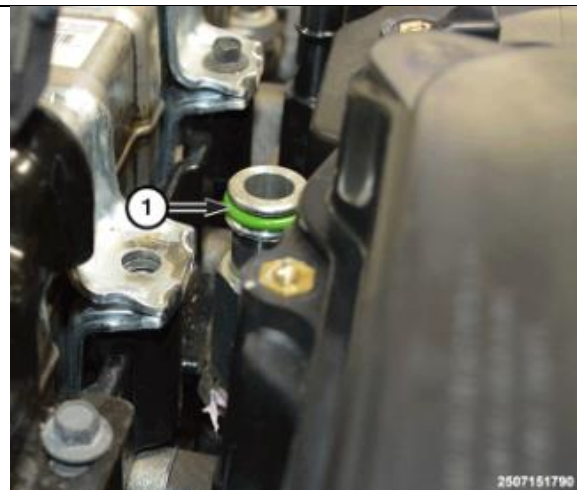

16. Install the rear coolant tube onto the EGR cooler and tighten the outer bolt to **24 Nm (18 ft-lbs)**.

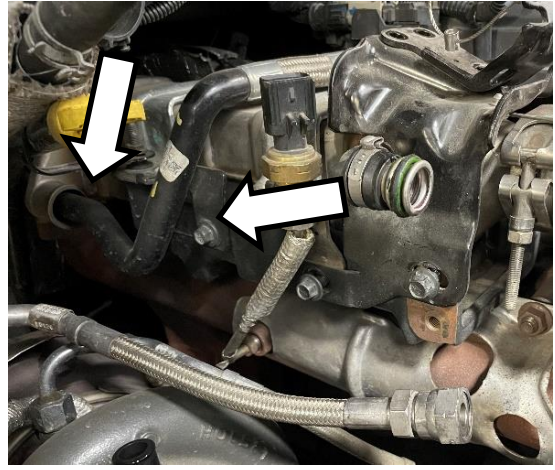

17. Tighten the rear coolant tube inner bolt to **24 Nm (18 ft-lbs)**.



18. Install upper EGR heat shield.

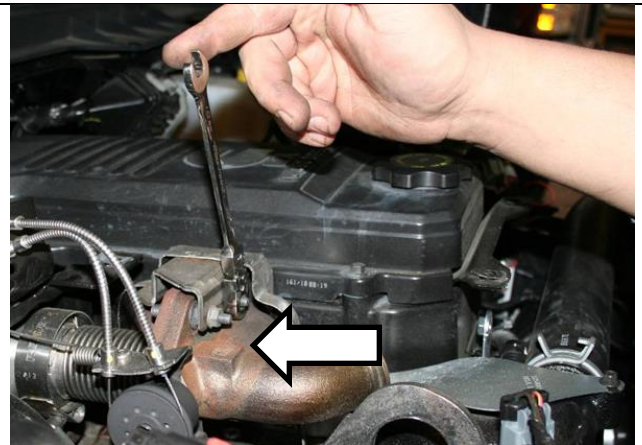

19. Connect EGR servo motor connector.



20. Connect the breather hose to the Closed Crankcase Ventilation (CCV) cover and turbocharger.
21. Connect exhaust back pressure sensor connector.

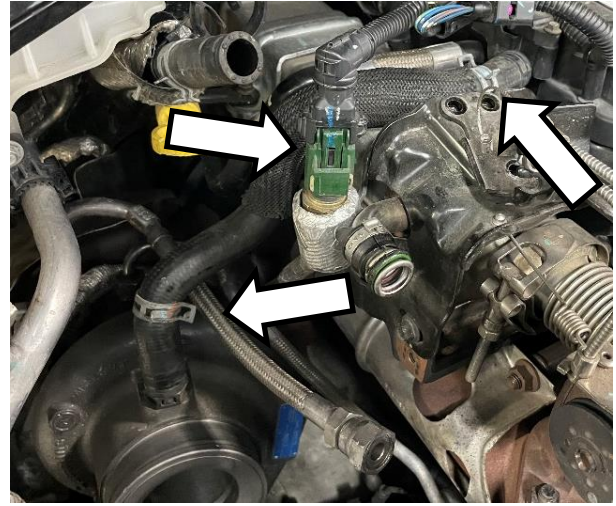

22. Install EGR cooler outlet connector. Lubricate the o-rings with coolant before installing.

Note: Check that the EGR Cooler has an outlet tube centering collar installed. If not, source from Mopar and install.



23. Install the lower EGR cooler outlet tube and tighten the bolt finger tight.

NOTE: Lubricate the o-rings with coolant.

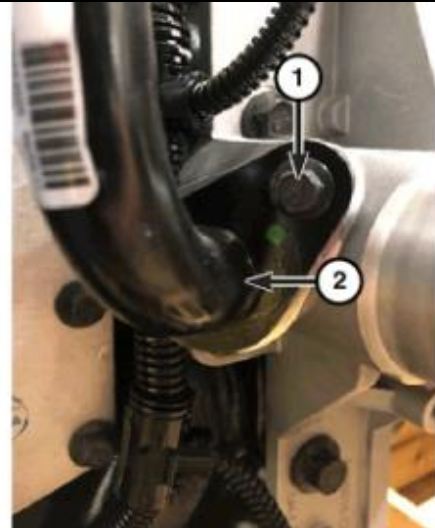

24. Install the EGR coolant outlet tube to the EGR Cooler.

25. Install the EGR coolant outlet tube upper bolt and tighten both to **10 Nm (89 in-lbs)**.



26. Install the coolant bottle hose to the EGR coolant outlet tube.

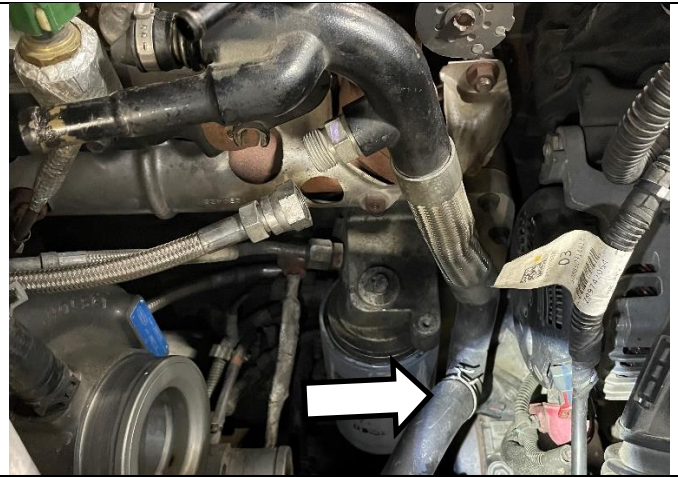

27. Install the heater hose, vent hose and turbocharger return coolant line to the EGR cooler outlet tube.

28. Install the coolant return line. Tighten the union nut to **35 Nm (26 ft-lbs)**.

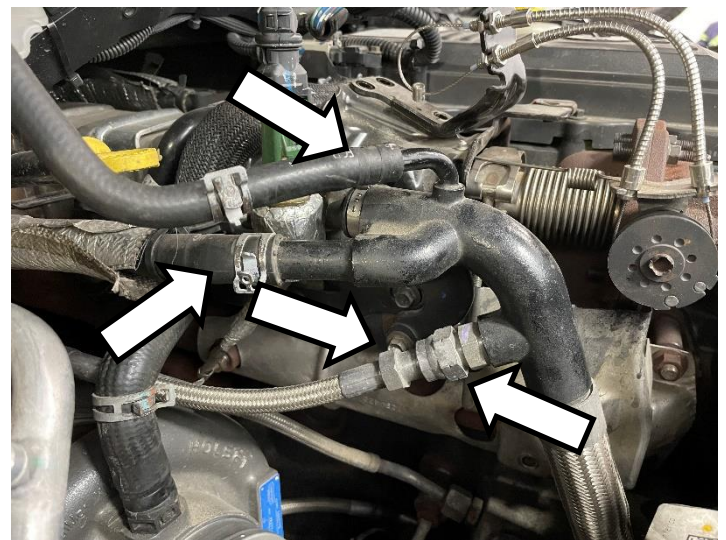

29. Install the transmission fill tube to the EGR cooler and tighten.

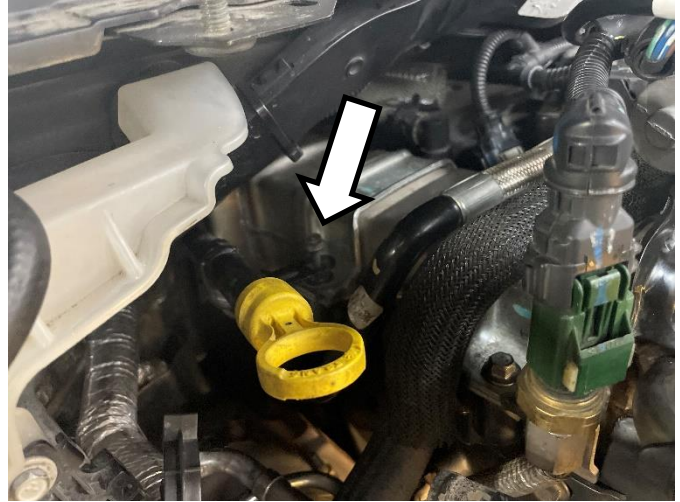

EGR Installation for Cab Chassis

1. Install the 1/8" NPT to M12 fitting on port 2 of the manifold. Torque fitting to **0.79 Nm (7.0in-lbs)**.



2. Using a hacksaw or cut-off wheel, cut the EGR back pressure sensor tube bracket at the spot shown.

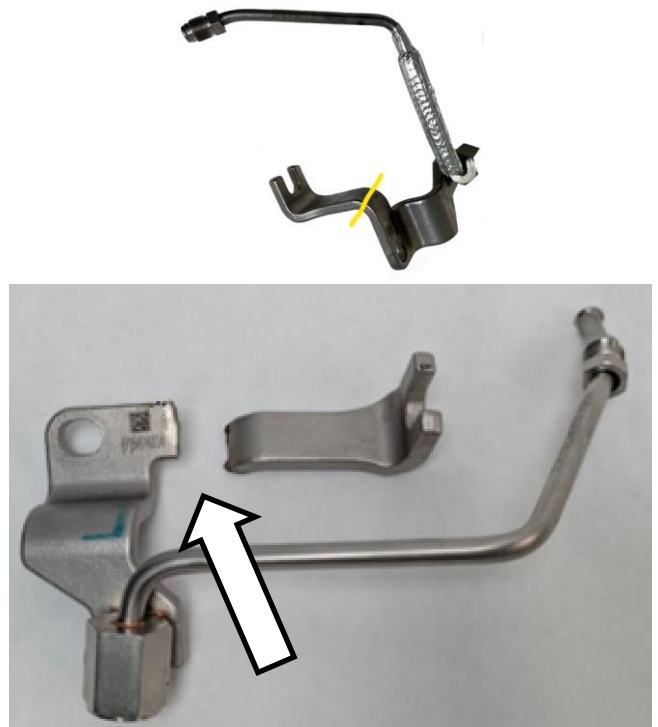

- Using the supplied EBP tube bracket and the heat shield exhaust manifold bolt, nut, and spacer saved from the removal steps, install the brackets and tube as shown. (Note: manifold is shown on bench for clarity). Install the NPT fitting and torque to **0.79 Nm (7.0in-lbs)**. Torque the M8 flange bolts to **24 Nm (18 ft-lbs)**.

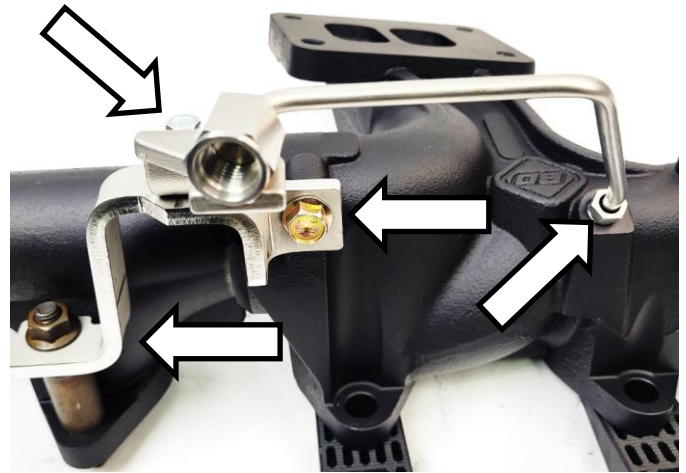

- Install the rear exhaust pressure sensor and tighten to **24 Nm (18 ft-lbs)**.
- Connect the rear exhaust pressure sensor wire harness connector (1).

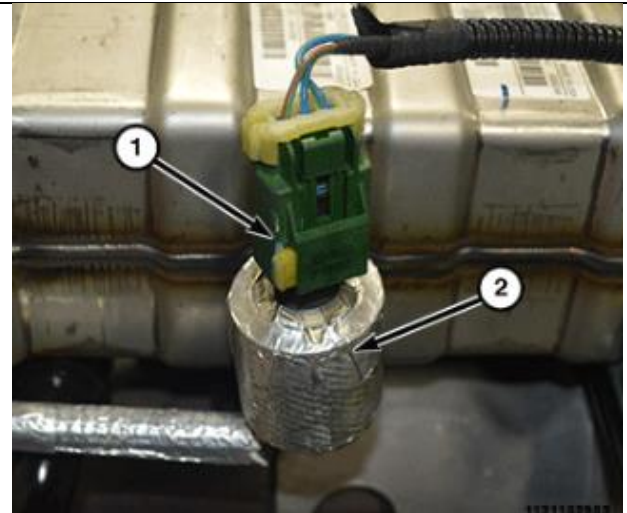

- Install the front exhaust pressure sensor tube (2) and tighten the fitting (1) to **0.79 Nm (7.0in-lbs)**. Install the bolt securing the front exhaust pressure sensor tube to the EGR cooler bracket (3) and tighten to **24 Nm (18 ft-lbs)**.



7. Install the exhaust pressure sensor and tighten to **24 Nm (18 ft-lbs)**.
8. Install the front exhaust pressure sensor heat shield (2).
9. Connect the front exhaust pressure sensor wire harness connector (1).

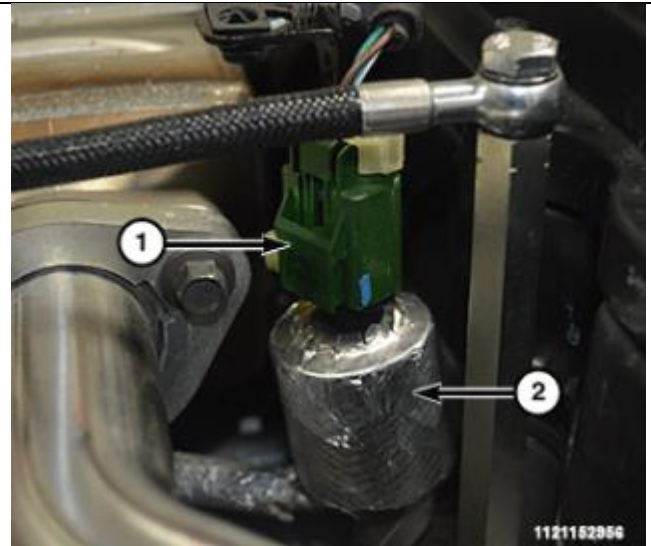

10. Install the EGR cooler elbow and gasket onto the EGR cooler and tighten the nuts to **24 Nm (18 ft-lbs)**.
11. Install the EGR cooler and tighten flange nuts to finger tight.

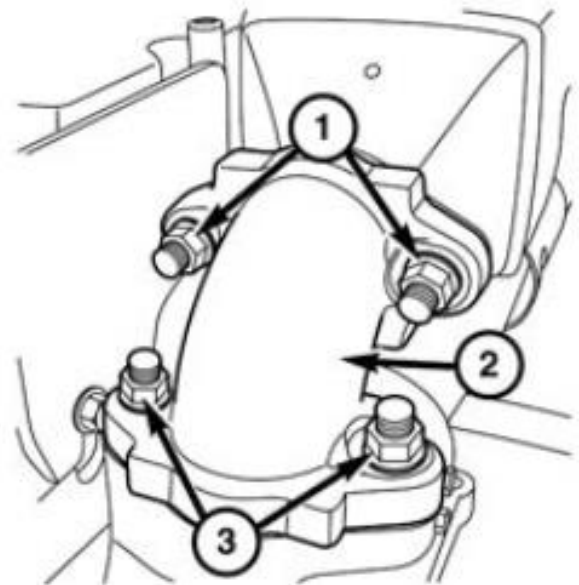

12. Install the EGR Cooler and tighten all the mounting bolts to **36 Nm (27 ft-lbs)**.

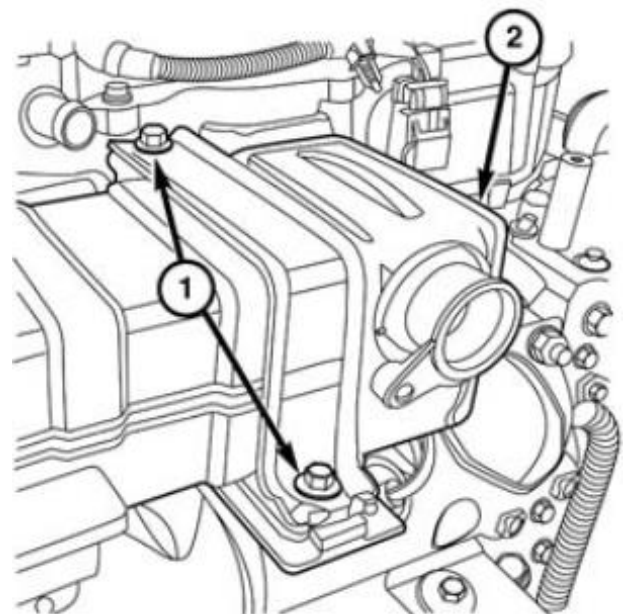

13. Install the EGR tube with gasket seals to the engine and tighten bolts finger tight.

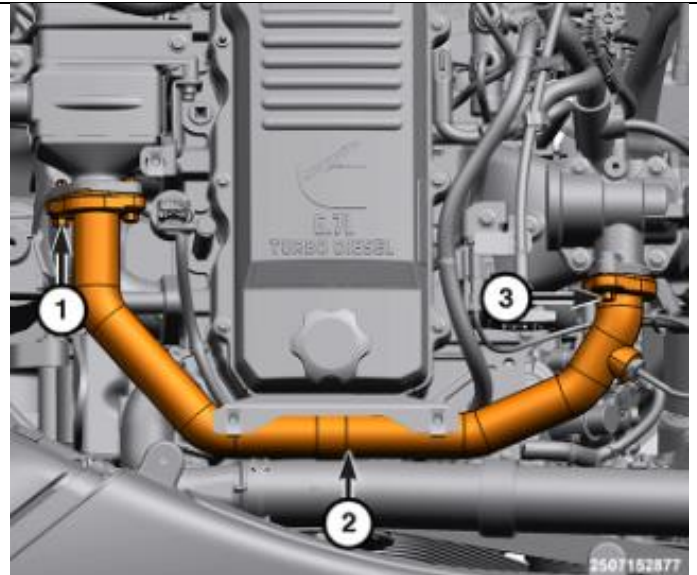

14. Install the EGR tube support bracket bolt and tighten to **36 Nm (27 ft-lbs)**.

15. Tighten EGR crossover tube bolts on the EGR cooler side and EGR valve side to **24 Nm (18 ft-lbs)**.

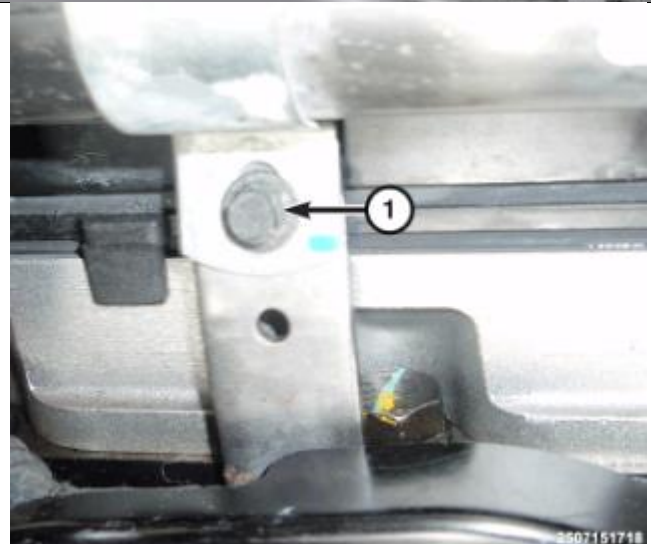

16. Install cable ties securing exhaust gas temperature sensor wire harness connector to EGR valve wire harness (2).

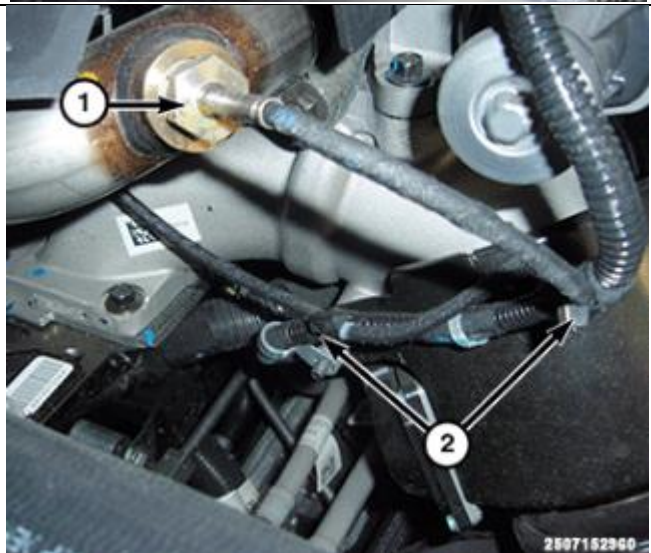

17. Connect the EGR temperature sensor harness connector (1).

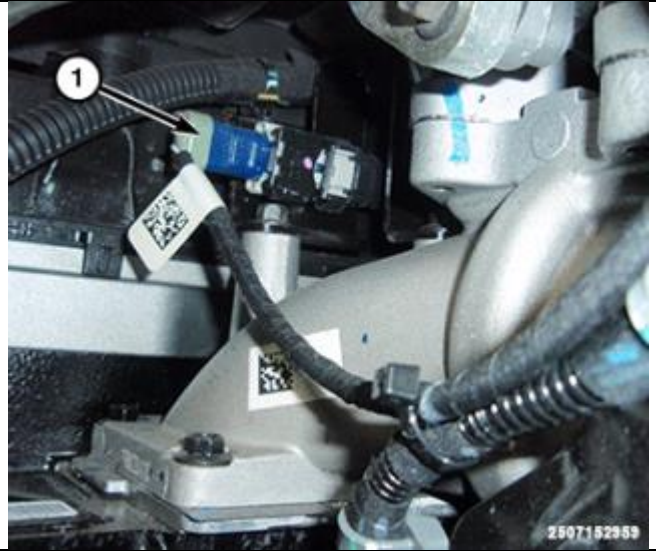

18. Install the lower EGR cooler inlet tube and tighten the bolt to **10 Nm (89 in-lbs)**.

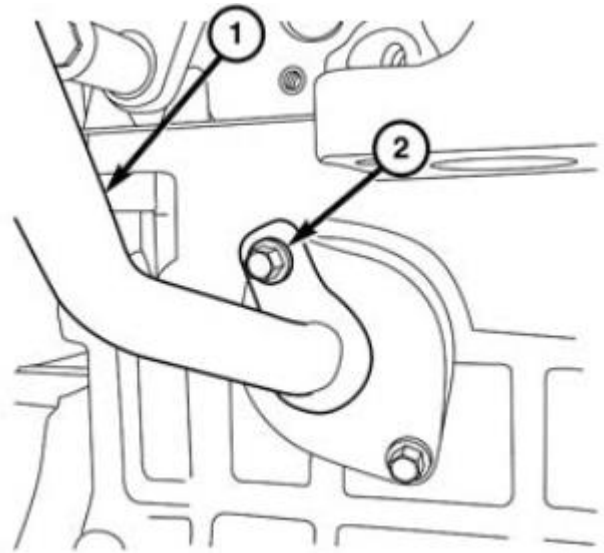

19. Install the rear EGR cooler inlet tube into EGR cooler and tighten the bolt to **10 Nm (89 in-lbs)**.

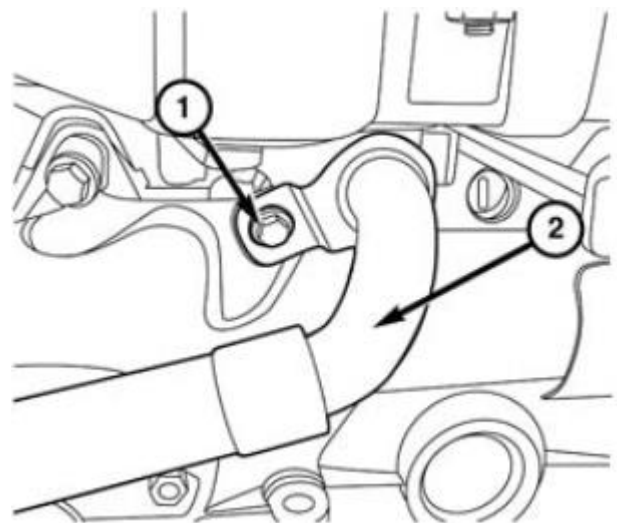

20. Install the cooler outlet tube into EGR cooler and tighten bolt to **10 Nm (89 in-lbs)** for M6 bolts and **24 Nm (18 ft-lbs)** for M8 bolts.

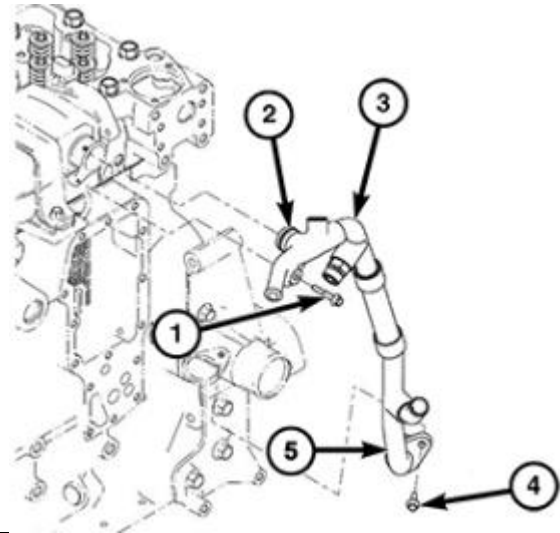

21. Install the turbocharger coolant return tube union nut (4) onto the coolant outlet tube and tighten to **35 Nm (26 ft-lbs)**.

22. Install the banjo bolt (2) onto EGR cooler outlet tube and tighten to **35 Nm (26 ft-lbs)**.

23. Connect coolant hose (3).

24. Connect the coolant bottle hose (1).

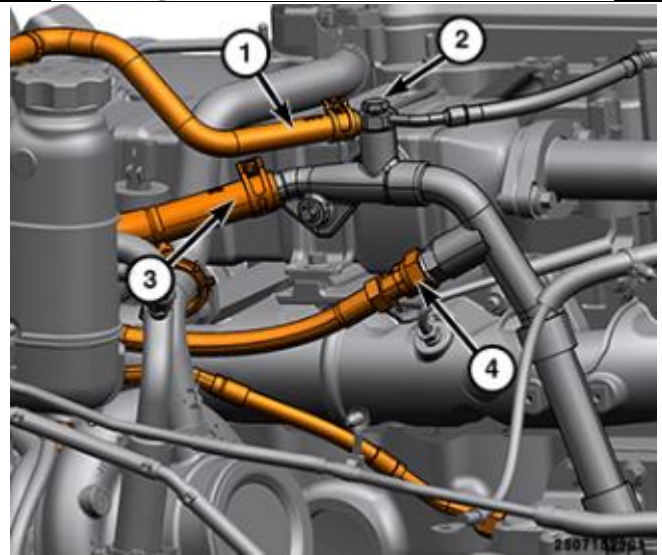

Airbox and Battery Installation

1. Install the right CAC tube, and tighten clamp nut to **11 Nm (8 ft-lbs)**.

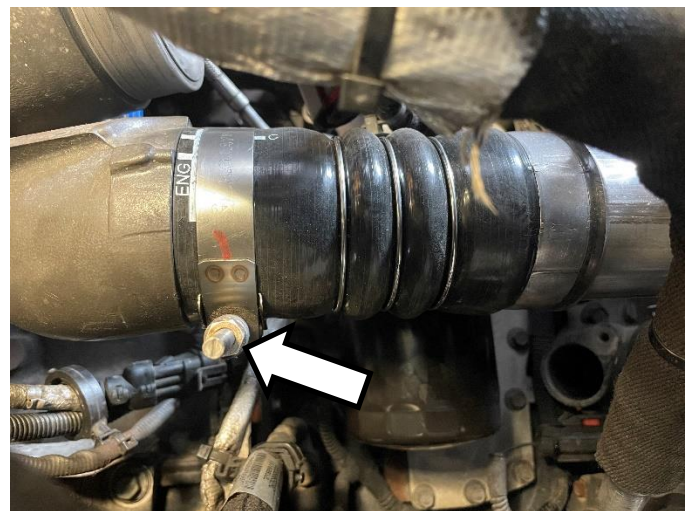

2. Connect the breather hose to the turbocharger and tighten the clamp.

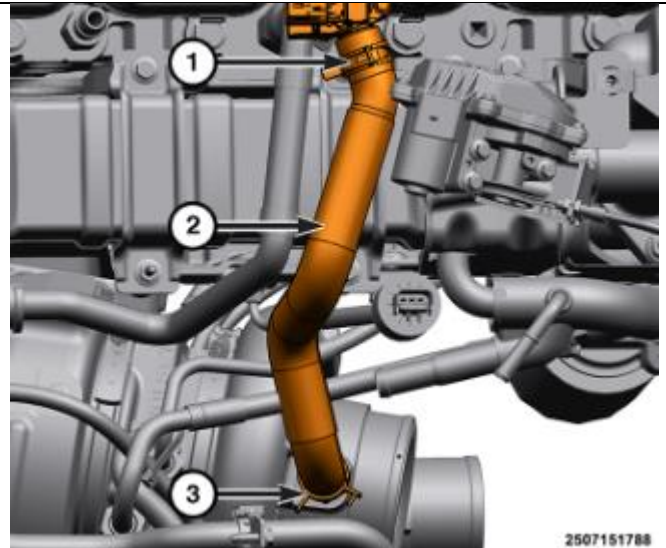

3. Install the battery tray and secure with the 2 bottom fasteners.

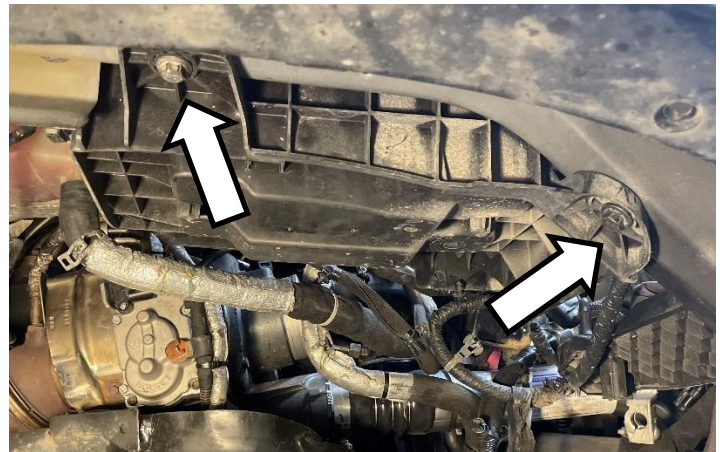

4. Install the 4 upper fasteners that secure the battery tray.

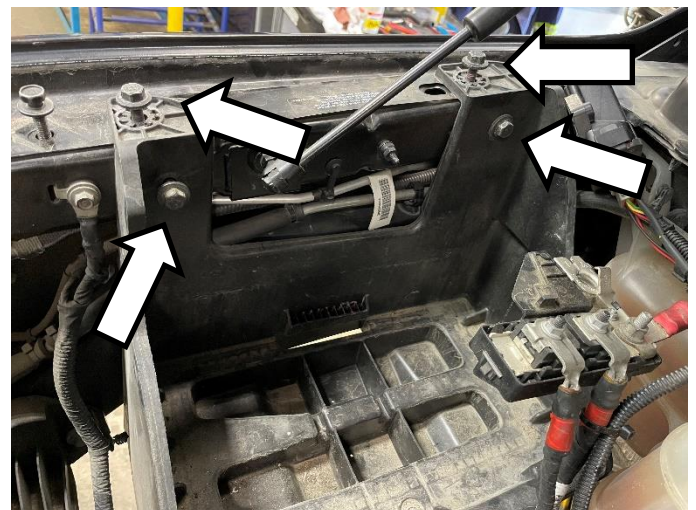

5. Install the two fasteners that secure the heater relay.



6. Install the passenger side battery and hold down.
7. Install the passenger side reinforcement beam.



8. Install the passenger side inner fender and wheel.



9. Install the 4 bolts securing the engine cover.

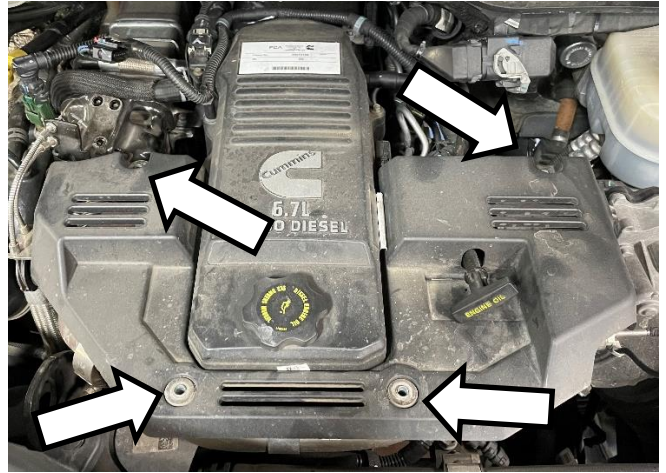

10. Install the air box and intake tube assembly and snap it into place.

11. Install the intake tube into air inlet duct.

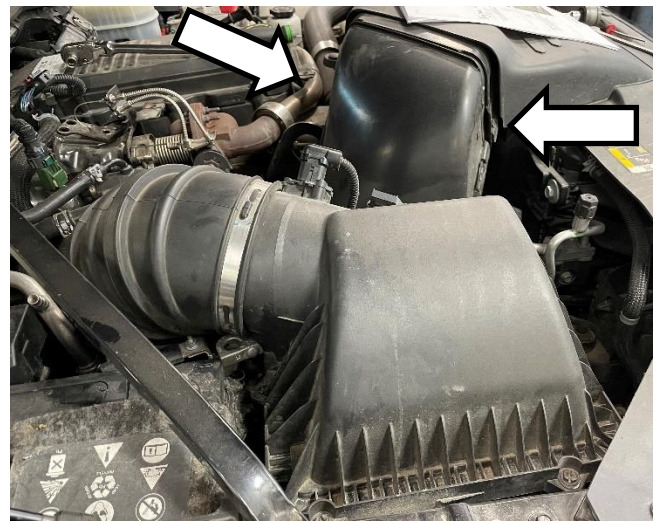

12. Install the intake tube and secure two clamps onto turbocharger and air cleaner.

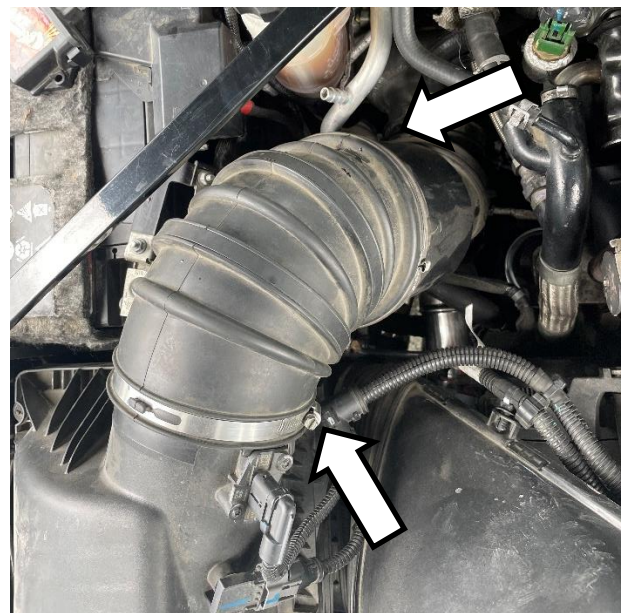

13. Connect the Mass Air Flow (MAF) sensor wire harness connector.
14. Connect the Temperature / Barometric Absolute Pressure (T/BAP) sensor wire harness connector.
15. Connect the wire harness to the air box.

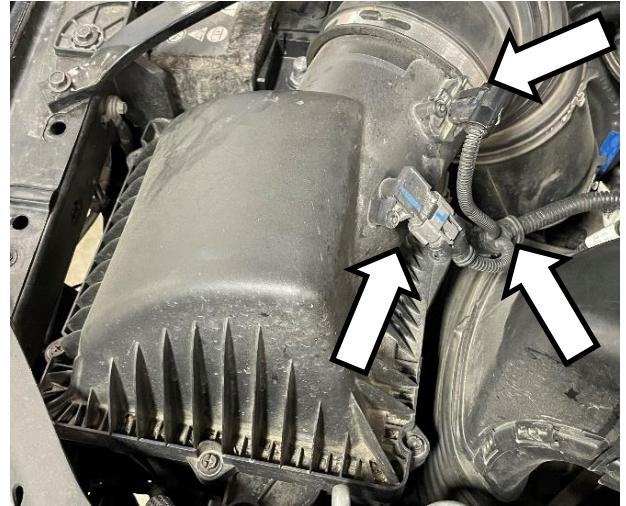

16. Connect and isolate both of the negative battery cables.
17. Connect the Intelligent Battery Sensor (IBS) wire harness connector.

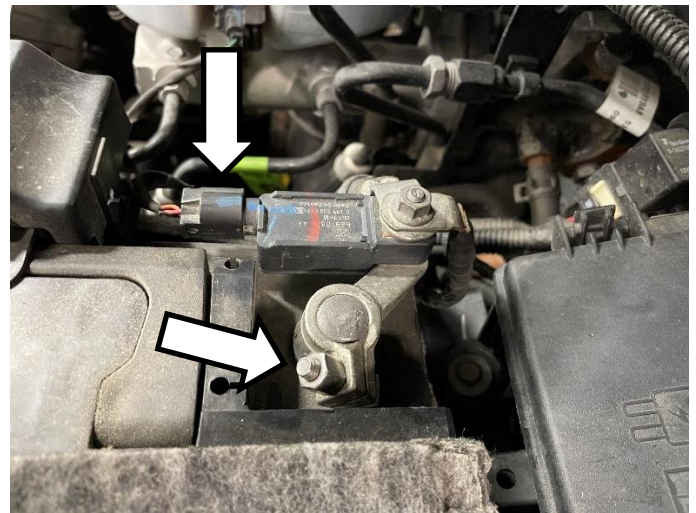

To complete the installation, fill the coolant system, start the engine and check for coolant or exhaust leaks.