



TITANIUM SIGNATURE SERIES PLUS INSTALLATION MANUAL

ALL 1/2" FUEL PORTS



Powerstroke 7.3L

Bypassing the Factory Lift Pump

1999-2003

Powerstroke 6.0L

Bypassing the Factory Lift Pump

2003-2007

Standard Pickup Truck

APPLICATION:

- TSP-F14-180F-140G
(140GPH @ 60-65 PSI)*
- TSP-F14-250F-220G
(220GPH @ 60-65PSI)*
- TSP-F14-290F-240G
(240GPH @ 60-65PSI)*

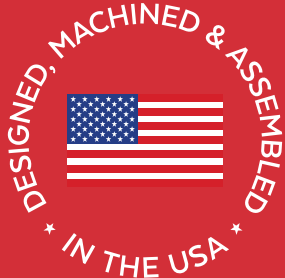

**Note: Cab and Chassis
may require modifications**



www.fassride.com

(866) 769.3747

Thank you for choosing FASS, from Diesel Performance Products, Inc.

FASS specializes in building extremely high-quality fuel products. We have earned an unsurpassed reputation for excellence in our industry by using only the highest-quality American-made components. In order to support our American workers and our American economy, more than 98+ percent of our products are manufactured completely in the United States.

Of course, that dedication to excellence comes at a price, but it is important to remember that price does not dictate quality-quality dictates price! We will never compromise by using cheaper, foreign-made components, like so many of our competitors do.

Customer satisfaction is our top priority and we strive always to provide outstanding customer service. Our Research and Development department, in conjunction with our Dealer Support Department, continually searches for ways to improve quality, expand our product line, and provide superb support. Our exclusive ViP Network ensures that customers receive the proper products and support at the local level. The extended lifetime warranty is only available on products purchased from the network. There is no warranty on products not purchased outside the network.

IMPORTANT:

In order to qualify for the lifetime extended warranty, your product registration form and proof of purchase from an authorized dealer must be submitted to FASS Fuel Systems within 30 days of purchase. Failure to comply will void the warranty. We have the right to deny any warranty believed to be false, altered or purchased through an unauthorized or terminated dealer. A current list of authorized dealers can be found on our website, FASSRide.com.

The complete conditions of the Limitation of Warranty can be found in the back of this manual, and FASSRide.com.

**For more information,
contact Technical Support:
Diesel Performance Products, Inc.
16234 State Hwy O.
Marthasville, MO 63357
636-433-5410**



WARNING!

This product has NO WARRANTY unless:

1. It has been purchased from an **Authorized or **ViP FASS Dealer**. If in doubt, check www.FASSRide.com.**

2. It is registered within thirty (30) days of purchase.

Other conditions may apply. Please see full warranty information.

***NOTE:* Warranty is **void** if product was purchased below FASS website advertised pricing.**

ATTENTION!

Before you begin installation

Register for your Warranty ONLINE at

<https://www.fassride.com/register-a-warranty/>

No online access, call our TECH Support at

1-866-769-3747

FOLLOW THESE STEPS TO ENSURE A SIMPLE, CORRECT INSTALLATION OF YOUR NEW TITANIUM FUEL SYSTEM

ATTENTION:

Be sure to identify the proper FASS System and fuel line configuration. For help, our product finder can be found at www.FASSride.com. Follow the instructions to see fuel line detail.

1 Pay close attention to ALL WARNINGS

Read all instructions before starting

2 installation of this product.

3 Inventory the package components. Notify the place of purchase immediately of any parts missing or damaged.

4 The installation recommendations contained within are guidelines. Use good judgment and take into consideration your vehicle's accessories.

5 For best results in accuracy and efficiency (due to training, communication, and our relationship with our dealer network), we recommend a VIP FASS dealer for the installation. They are prepared to install the FASS fuel pumps with the most efficiency. If a situation or problem arises during the installation, the dealer is prepared to handle it. Diesel Performance Products, Inc. is not responsible for any installation mistakes.

6 If you have any questions or concerns that cannot be addressed with your dealer, email or call FASS.

If any installation procedure is uncertain, contact FASS technical support. Call customer service at 636-433-5410, or send us an e-mail: techsupport@FASSride.com with the following information:

Your name, address and daytime phone number
Model (TSP-F14-180F-140G) or (TSP-F14-250F-220G)
or (TSP-F14-290F-240G)
Serial number
Last 6 digits of vehicles' VIN

Date of purchase
Nature of Your Concern
Serial number



INSTALLATION MANUAL
TSP-F14-180F-140G
TSP-F14-250F-220G
TSP-F14-290F-240G

(Installation Videos are available at www.fassride.com)

RECOMMENDED APPLICATION

TSP-F14-180F-140G: Powerstroke 1999-2007 with stock - 700 horsepower

TSP-F14-250F-220G: Powerstroke 1999-2007 with extreme horsepower modifications

TSP-F14-290F-240G: Powerstroke 1999-2007 with extreme horsepower modifications

1. **Read all instructions before starting installation of this product!**
2. **Installing the improper FASS Pump can cause severe engine damage.**
3. **Secure vehicle from ROLLING!**
4. **Cab and Chassis may require modifications**
5. **Consult vehicle's manufacturers' instructions concerning the electrical system before attempting any electrical connections.**
6. **Flush and clean all brass fittings and fuel line from debris.**
7. **Keep debris from entering the internals of the system during installation. Getting debris in the water separator nipple can lock up the motor. If the motor does lock up from debris call FASS for technical assistance.**

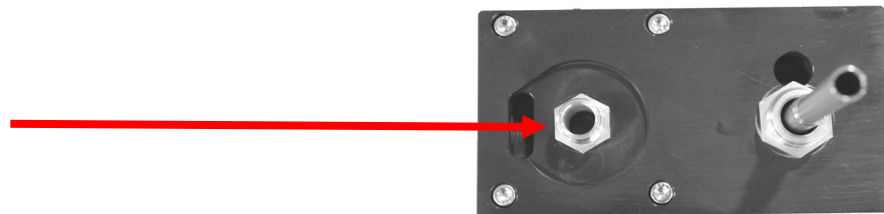

9. **Wear safety glasses when operating power tools such as drills and grinders or when using a punch or chisel.**
10. **Properly secure lines to prevent chaffing.**

BEFORE STARTING THE INSTALLATION PROCESS LUBRICATE THE BED BOLT WITH WD-40 TO HELP WITH INSTALLATION



WARNING!

Always be sure to fill the fuel tank to full after a new FASS installation. Failure to do so can result in excessive sound output, or priming issues!

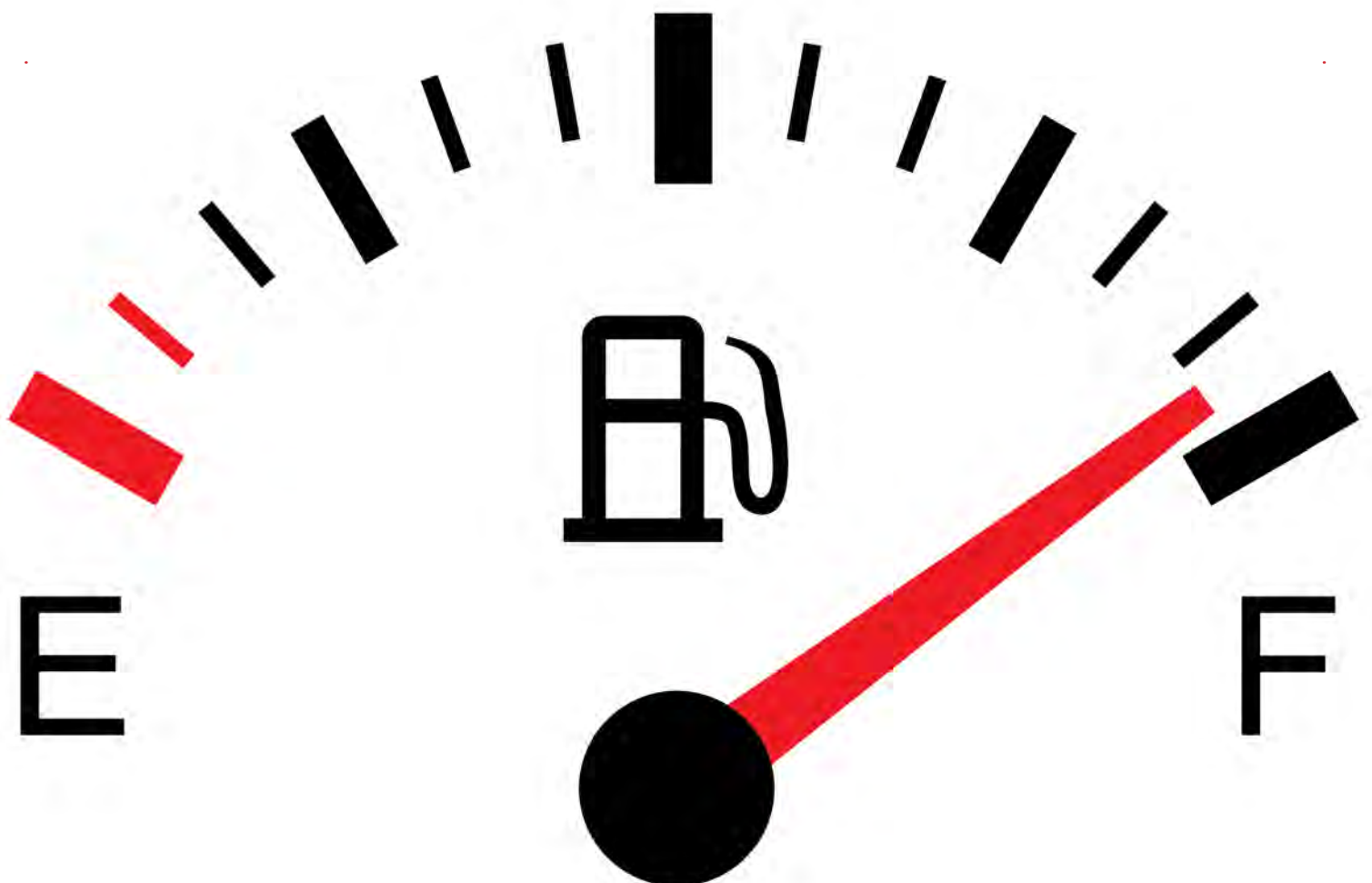

TITANIUM SIGNATURE SERIES PLUS 140 GPH or 220 GPH or 240 GPH

60-65 psi (Approximately)

Rear View



Front View



PUMP GUIDE:

- 1. "E" To Engine**
- 2. "R" Return to Tank**
- 3. Serial Number**
- 4. "T" Fuel Inlet**
- 5. Electric Heater Ports**
- 6. "G" Gauge Port**

INSTALLATION GUIDE:

- Step 1. Install Electrical Harness**
- Step 2. Prep the FASS**
- Step 3. Mount the FASS**
- Step 4. Fuel Line Supply**
- Step 5. Review Installation**

TITANIUM
SIGNATURE SERIES PLUS
140 GPH or 220 GPH or 240 GPH

60-65 PSI (Approximately)

Note: Going over 100 PSI WILL void warranty.

NOTE: WARRANTY MAY BEVOID IF SILICONE BAND IS REMOVED FROM MOTOR!!

The silicone band is in place to retain motor wires, preventing damage to the electric motor.



CONTENTS

NOTE: Owner's Manual available for download on our website,
www.FASSride.com



DIELECTRIC GREASE



**TWO (2)
OR-017**



OR-030

NOTE: THESE SPARE BASE O-RINGS ARE INCLUDED WITH THE KIT IN THE EVENT OF A PINCHED O-RING DURING ASSEMBLY



MP-TSP-9045

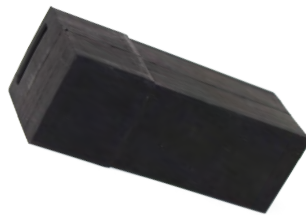

RELAY COVER



FL-1058-BK x 3'



RS-2001



FL-1002-BK x14'



WH-1006-3



PBR-2001



PFB-2002



PFB-2001C

MOUNTING PACKAGE CONTENTS



TWO (2)
PL-1005-BK



AN-10-ORB-10-BK



AN-8-ORB-10-BK



PL-2058-BK



PL-10-ORB-8-BK



PL-8-ORB-8-BK



TWO(2)
PLB-12516



PLB-1238



BHF-1003



BHN-1001-BK



LW-1001



OR-223



THREE (3)
HEX BOLT
1/4"-20x1
3/4"

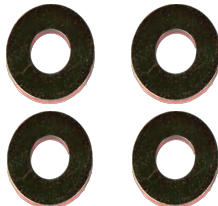

FOUR (4)
3/8" WASHERS

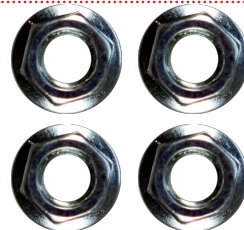

FOUR (4) LOCKING
NUT 3/8"



FOUR (4)
Hex Bolt 3/8" -16x11/2"



TWO (2) RING
TERMINAL



THREE (3)
WA-1001D



46044



46260

MOUNTING PACKAGE CONTENTS



CABLE TIES

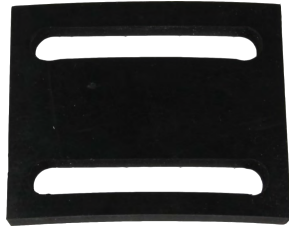

RS-2002



ST-1005Px16"



1/2" WASHERS



**HEX BOLT
1/2" -20x13/4"**



RS-2001C



HC-1001



QC-PLUG-516



QC-PLUG-38

STEP 1:
INSTALL ELECTRICAL HARNESS

The installation of the electrical harness is done first, allowing power to be applied to the pump for lubrication purposes later in the installation.

**NOTE: USE SUPPLIED DIELECTRIC GREASE
SPARINGLY ON ALL ELECTRICAL
CONNECTIONS!**



STEP 1:
INSTALL ELECTRICAL HARNESS

The installation of the electrical harness is done first, allowing power to be applied to the pump for lubrication purposes later in the installation.

Install the Relay Cover onto the relay on the FASS harness.

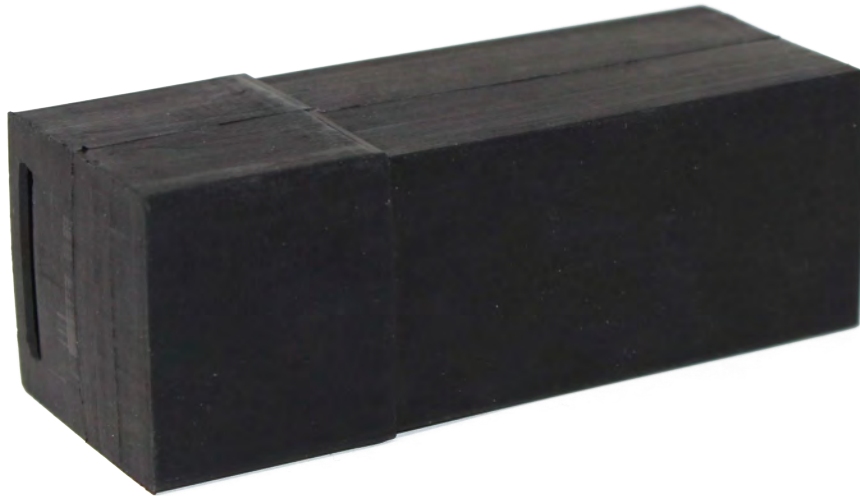

STEP 1:
INSTALL ELECTRICAL HARNESS

The installation of the electrical harness is done first, allowing power to be applied to the pump for lubrication purposes later in the installation.

**NOTE: BE SURE TO INSTALL THE SUPPLIED
30 AMP FUSE INTO THE FASS WIRING
HARNESS!!**



STEP 1: **INSTALL ELECTRICAL HARNESS**

The installation of the electrical harness should be completed first. This will allow power to be applied to the pump during installation.

- A.** Using wire stripping tool, remove excess insulation off the add-a-fuse and the WH-1006-3



STEP 1: **INSTALL ELECTRICAL HARNESS**

B. Place wire from 46044 single red bare wire from WH-1006-3 into butt connector. Using crimping tool connect 46044 and WH-1006-3 with butt connector. Install 46260 to 46044 top slot (opening that is near the spade).

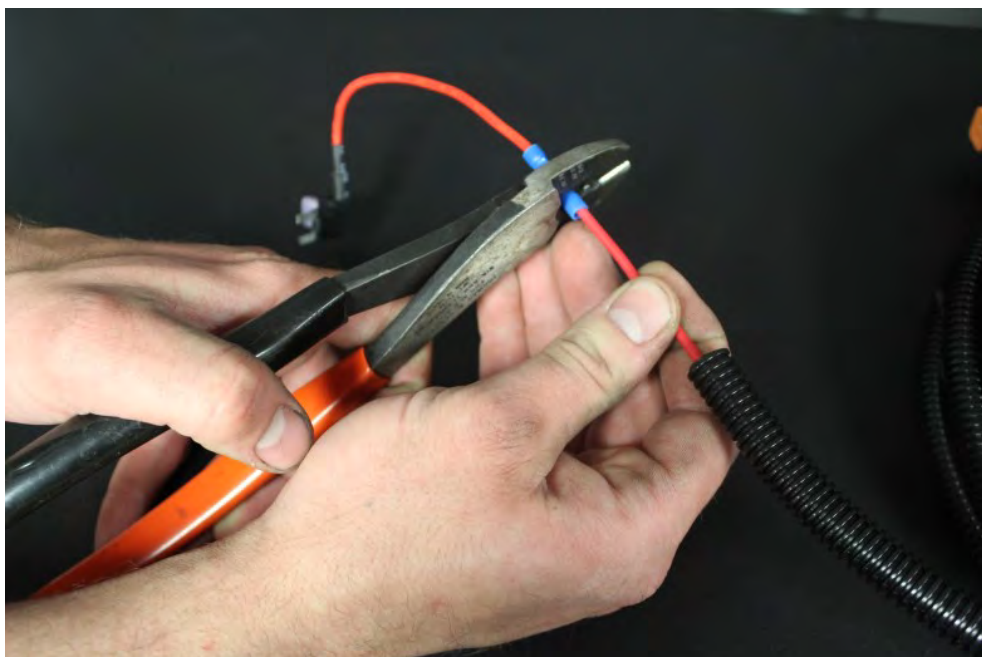
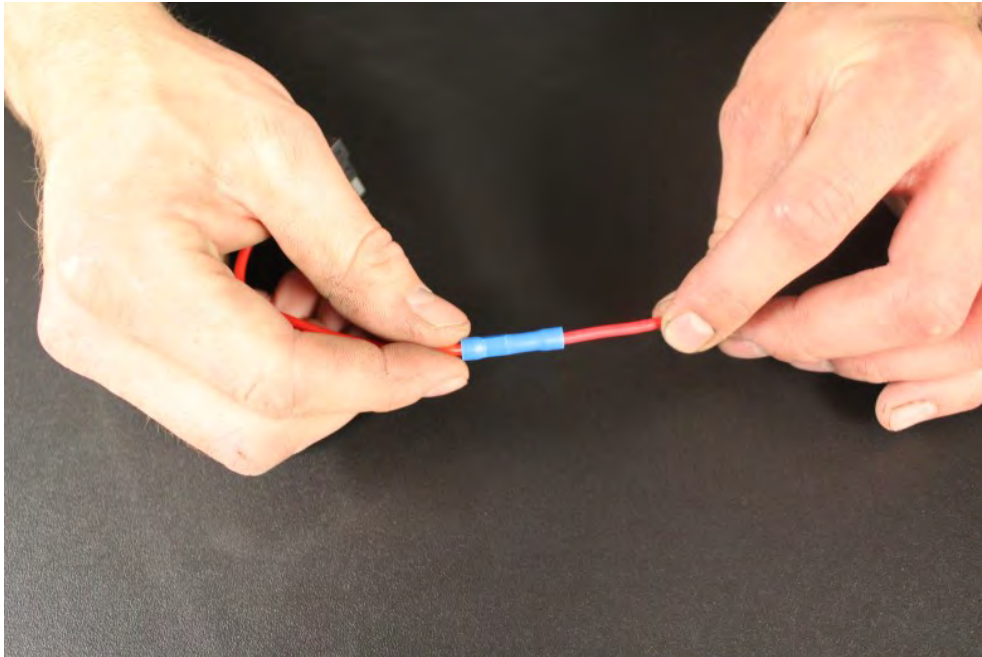

STEP 1: **INSTALL ELECTRICAL HARNESS**

C. Crimp the ring terminals to the red and green wires of the WH-1006-3 Wire Harness. Attach red wire to the positive terminal of the battery and the green terminal to the negative terminal. **The use of a corrosion preventative on electrical connections is recommended.**

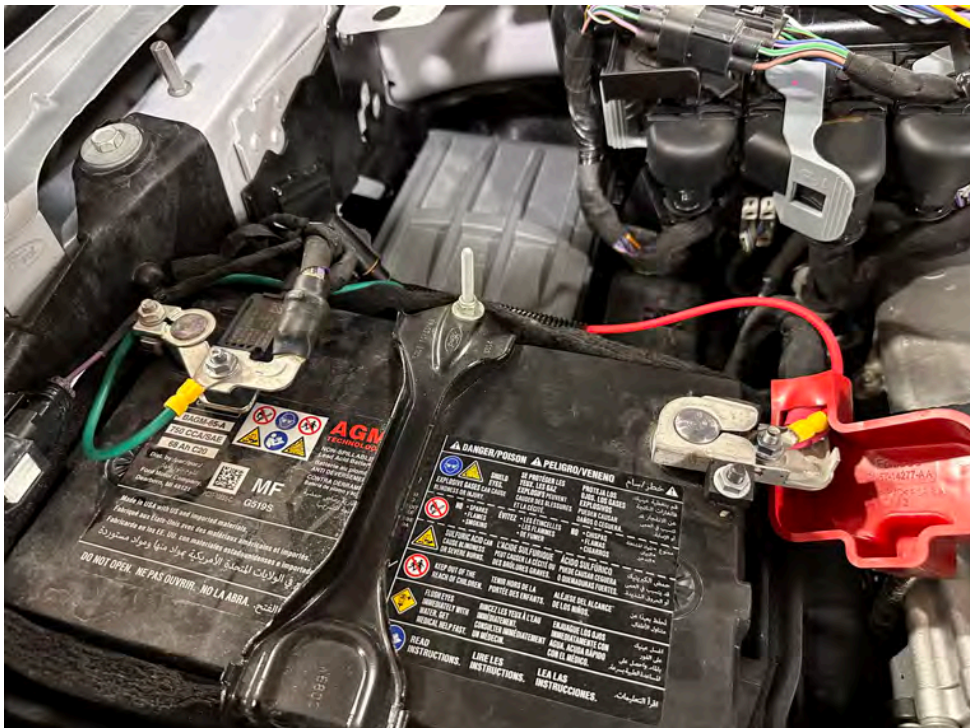
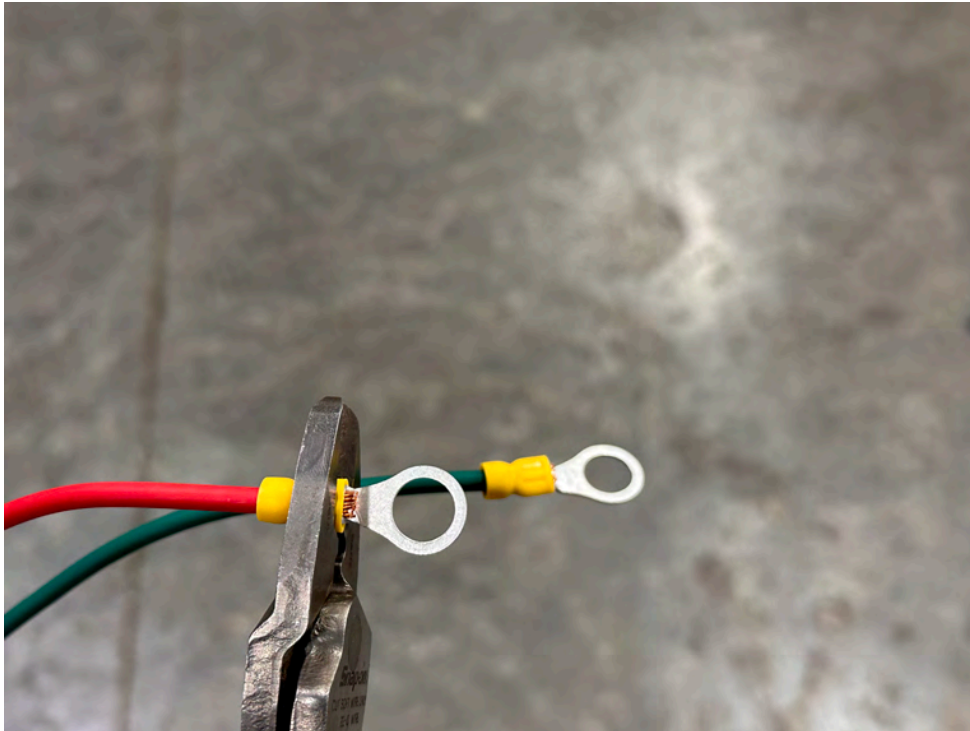

STEP 1: **INSTALL ELECTRICAL HARNESS**

D. Secure relay and fuse in an upright position, as shown, to prevent moisture from entering. Di-electric grease may be applied to prevent corrosion.

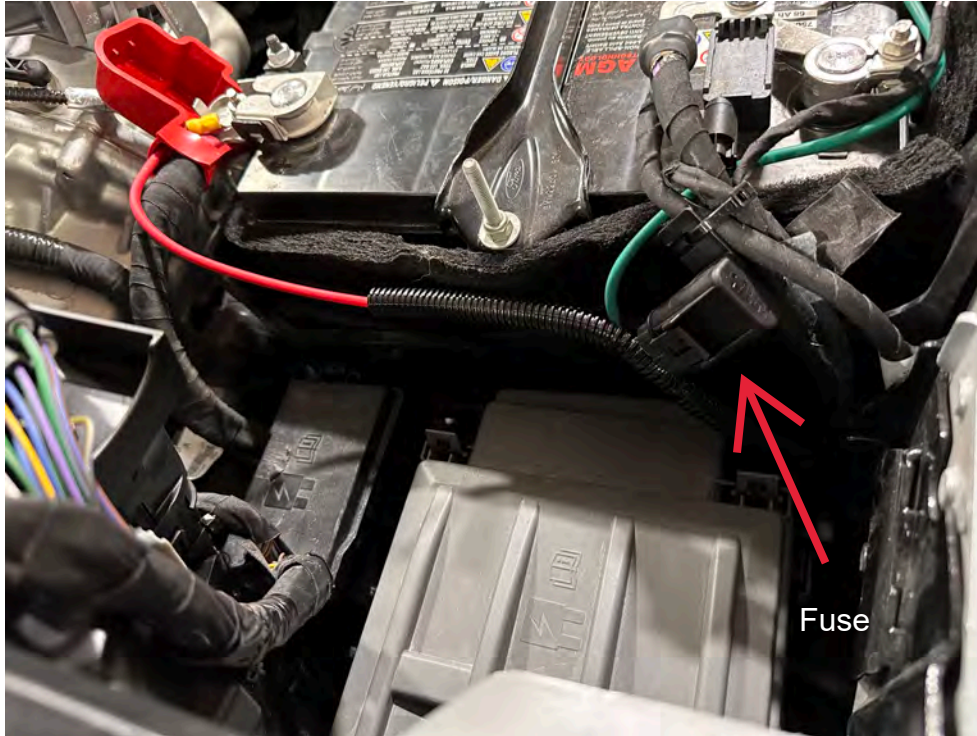

STEP 1: INSTALL ELECTRICAL HARNESS

E. Locate fuse box under hood and select ignition hot fuse. Remove fuse and put Add-A-Fuse in place. Install fuse previously removed. **The use of a corrosion preventative on electrical connections is recommended.**

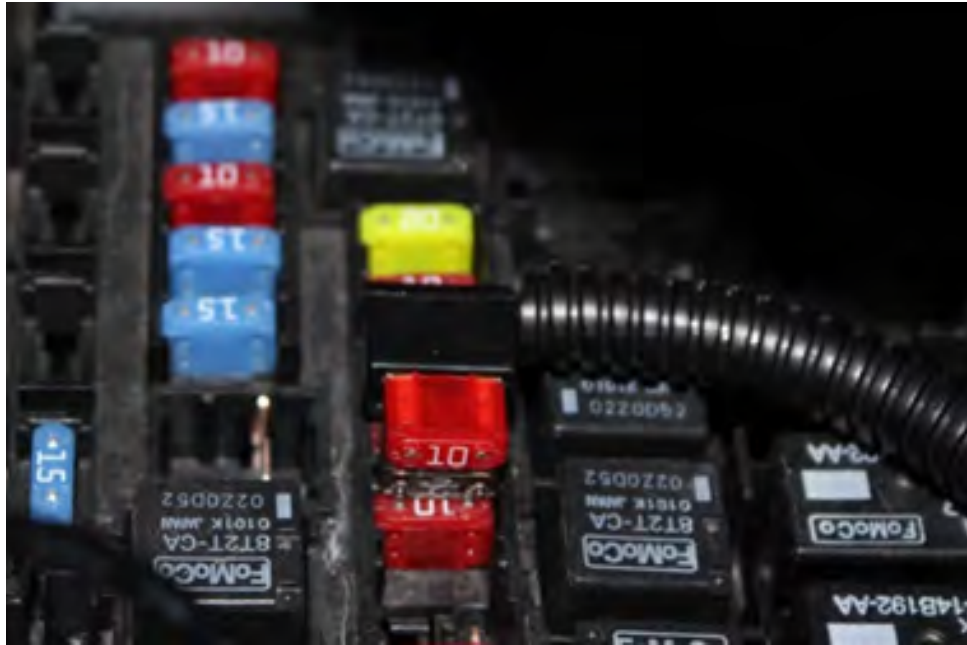
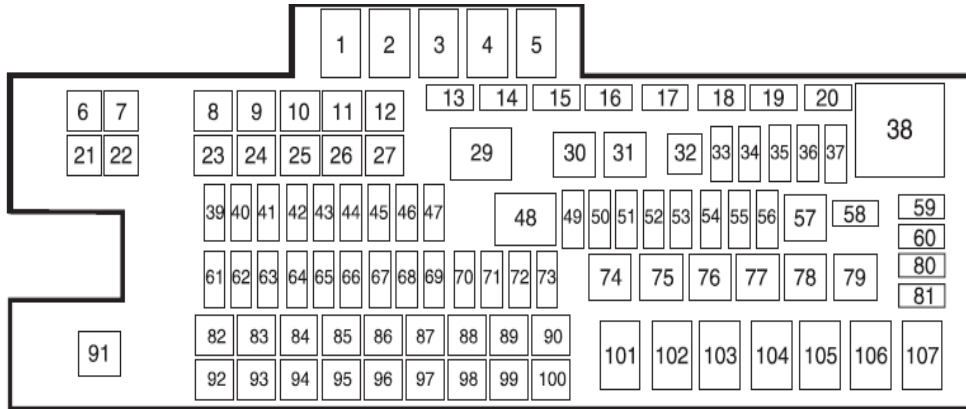



www.fassride.com

(866) 769.3747

STEP 1: ***INSTALL ELECTRICAL HARNESS***

F. Route WH-1006-3 wire harness along frame rail to mounting location of pump.
Completion of this step will be addressed in the Mounting Step 3.

STEP 2: **PREPARE SUCTION & RETURN LINES**

Some of the photo's are of a different application, procedures are the same..

NOTE: Hose clamps are not recommended for push lock fittings. They will hold up to 300psi! Use oil on fittings and inside fuel line when installing Push-Lok fittings.

- A.** Before tank is removed or moved, identify ALL areas of clearance between the tank and the truck's bed for the best location to install the BHF assembly. With proper clearance, you want to install it as close to the Fuel sending unit as possible.



STEP 2: **PREPARE SUCTION & RETURN LINES**

Some of the photo's are of a different application, procedures are the same..

Helpful Hint: If more space is required to access the top of the fuel tank, loosen the strap nuts to the end of the stud. This will gain you about 3" more working room.

B. Remove the filler neck and overflow tubes from the truck by loosening the clamps at both ends.

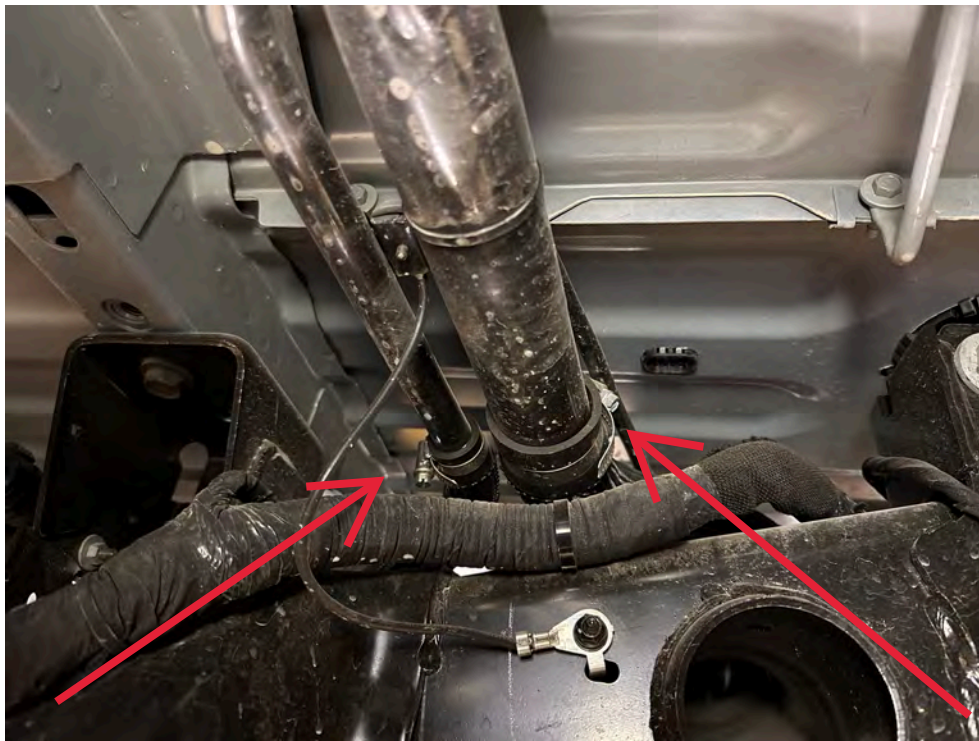

STEP 2: **PREPARE SUCTION & RETURN LINES**

Some of the photo's are of a different application, procedures are the same..

- C. Disconnect th factory wire harness, suction line and return line by pinching in side tabs.



STEP 2: **PREPARE SUCTION & RETURN LINES**

Some of the photo's are of a different application, procedures are the same..

D. With the fuel tank empty of fuel, remove it from the vehicle.



STEP 2: **PREPARE SUCTION & RETURN LINES**

Some of the photo's are of a different application, procedures are the same..

- E. Clean the fuel module area then remove the lock ring on the top of the fuel tank.



STEP 2: **PREPARE SUCTION & RETURN LINES**

Some of the photo's are of a different application, procedures are the same..

F. Once the lock ring is removed, carefully remove pick up module from fuel tank without bending fuel level arm.



STEP 2: **PREPARE SUCTION & RETURN LINES**

Some of the photo's are of a different application, procedures are the same..

G. Using a cup, reach inside the tank under the hole location to catch debris. Drill a 1 3/8" hole. Remove debris from top of tank.



STEP 2: **PREPARE SUCTION & RETURN LINES**

Some of the photo's are of a different application, procedures are the same..

H. Use blocks or similar to support tank during measurement, simulating tank "hanging" by the straps. Failure to do so may result in a short draw tube.



STEP 2: **PREPARE SUCTION & RETURN LINES**

Some of the photo's are of a different application, procedures are the same..

I. Assemble the BHF-1003 with PL-10-ORB-8-BK into port "S" and PL-8-ORB-8-BK into port "R". Push ST-1005P onto the barb portion of BHF-1003 and secure using HC-1001. Insert O-ring into groove.

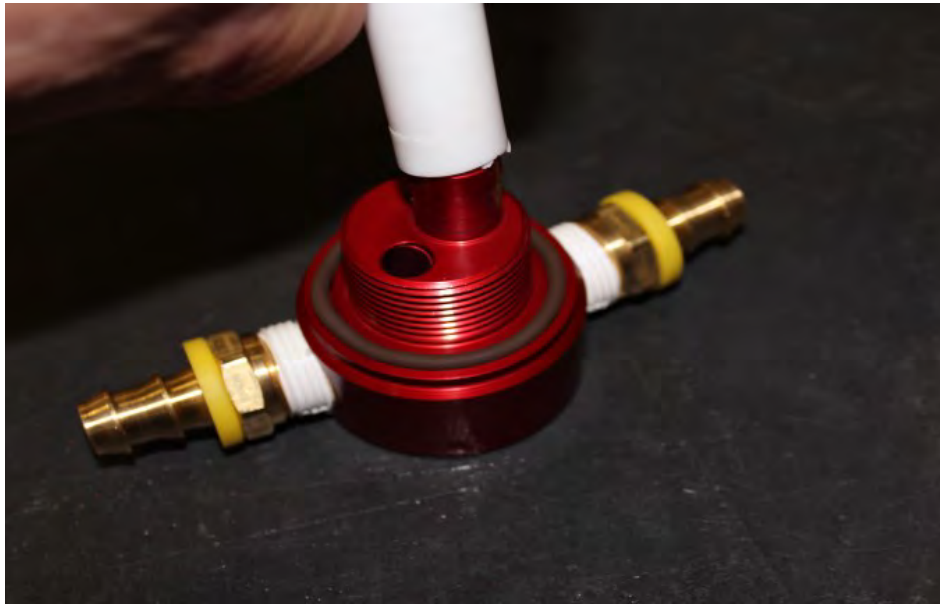

STEP 2: **PREPARE SUCTION & RETURN LINES**

Some of the photo's are of a different application, procedures are the same..

J. Place the suction tube assembly into hole. Take measurements so the bottom of the suction tube is only 1/8" (no more than 2 quarters stacked) from the bottom of the fuel tank. Before cutting the suction tube, triple check the measurements. It is more efficient to cut the tube too long and then correct to proper length than it would be to cut too short.



STEP 2: **PREPARE SUCTION & RETURN LINES**

Some of the photo's are of a different application, procedures are the same..

K. With proper length being obtained with the suction tube, de-bur and flush assembly. Slide tube through hole, lock washer, and nut. Make sure O-ring on bottom of bulkhead fitting remains in it's groove. With BHF-1003 properly seated against tank, tighten nut.



STEP 2: **PREPARE SUCTION & RETURN LINES**

Some of the photo's are of a different application, procedures are the same..

- L. Carefully reinstall install pick up module making sure the leveling arm is not obstructed by the suction tube. Reinstall factory lock ring.



STEP 2: **PREPARE SUCTION & RETURN LINES**

Some of the photo's are of a different application, procedures are the same..

M. Attach 5/8" fuel line to PL-10-ORB-8-BK and the 1/2" fuel line to the PL-8-ORB-8-BK. Remember to oil the fitting and fuel line. Loop fuel line over frame rail when reinstalling fuel tank. Do not cut at this time.



STEP 2: **PREPARE SUCTION & RETURN LINES**

Some of the photo's are of a different application, procedures are the same..

N. Reinstall fuel tank. Remember to reconnect factory suction, factory return line, and electrical harness. Torque tank hanger bolts to proper specifications. Reattach filler neck and clamps.



NOTE:

ATTENTION: While installing fittings into Titanium pump
DO NOT Apply side pressure to draw tube of pump

PROPER



IMPROPER

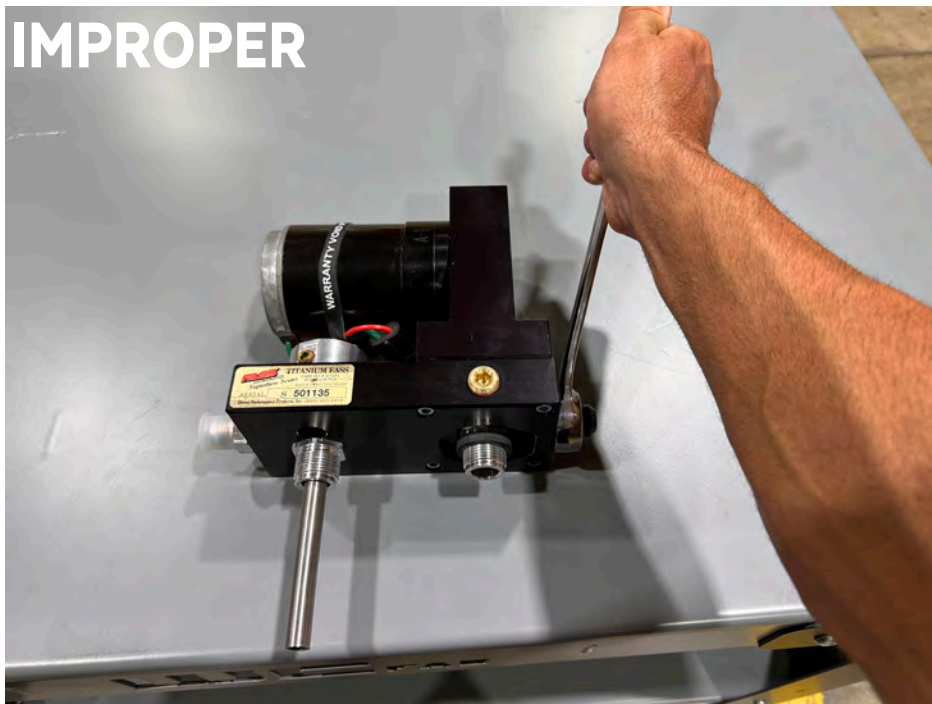

STEP 3: **MOUNT FUEL SYSTEM**

NOTE: Before installing fittings make sure to inspect for burs or flare imperfections. When cutting fuel line make sure to blow out line to keep debris from moving forward..

A. Install AN-8-ORB-10-BK into the "E" port and AN-10-ORB-10-BK into the "T" port of the FASS, torque to 18ft./lbs.



STEP 3: **MOUNT FUEL SYSTEM**

B. For fitting purposes. Secure PBR-2001 to pump assembly lightly with (3) 1/4"-20x1 3/4 bolts and (3) WA-1001D. Assembly will be used in future steps for correct fitting of brackets. *(Note: Bracket may-be flipped to accommodate your application.)*

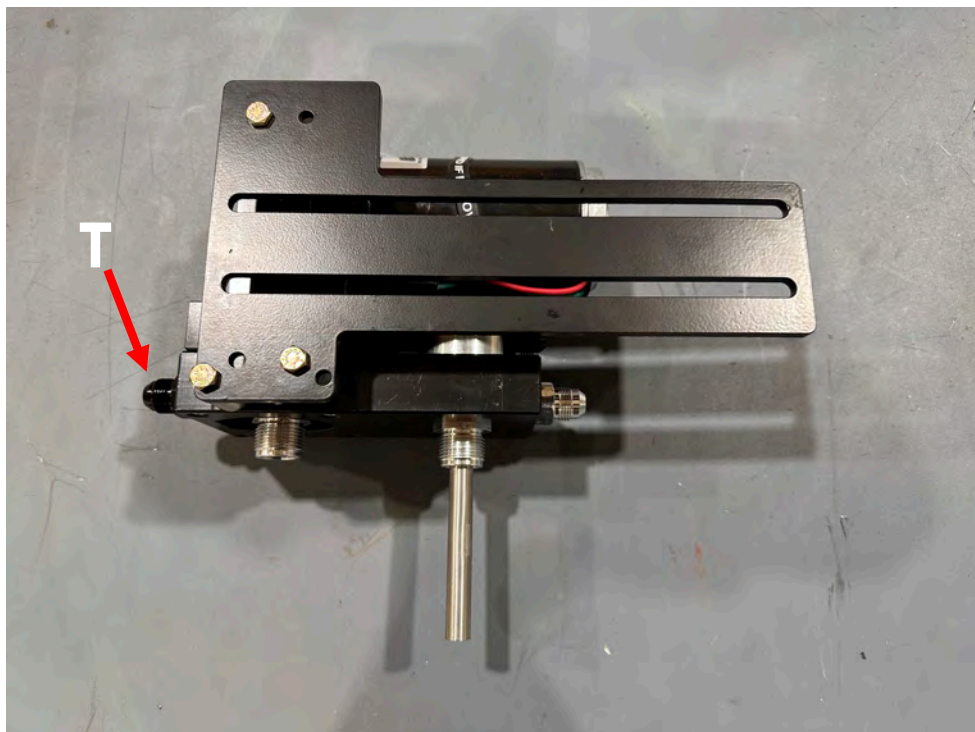
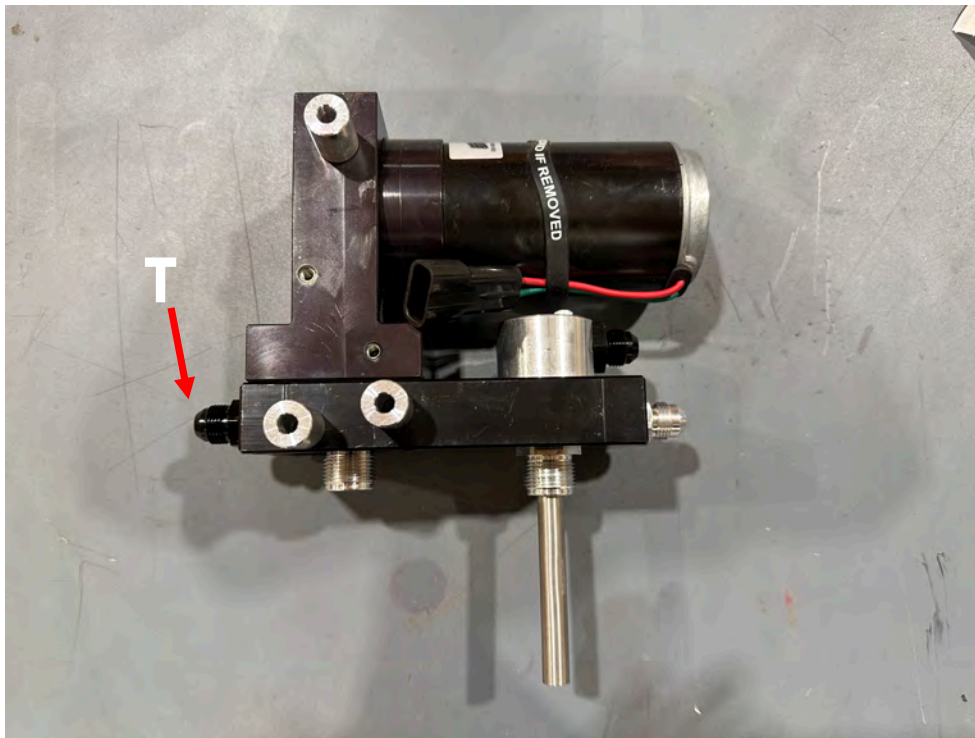

STEP 3: **MOUNT FUEL SYSTEM**

C. Assemble PFB-2002 and RS-2001C RS will make contact with bed channel when assembled correctly. Insert the PFB-2002 assembly in to bed channel align the nut with the opening on the channel.



STEP 3: **MOUNT FUEL SYSTEM**

D. Secure PFB-2002 and RS-2001 with (1) hex bolt 1/2" -20 x 1 1/2" and (1) 1/2" washer to PFB-2002C.



STEP 3: **MOUNT FUEL SYSTEM**

1999-2003 WITH 7.3 POWERSTROKE

- E.** Disconnect power supply wire from the OEM lift pump, be sure to isolate any exposed wire/terminals with electrical tape or heat shrink.



STEP 3: **MOUNT FUEL SYSTEM**

2003-2007 WITH 6.0L POWERSTROKE

- E.** Disconnect power supply wire from the OEM lift pump, be sure to isolate any exposed wire/terminals with electrical tape or heat shrink.

Factory power plug

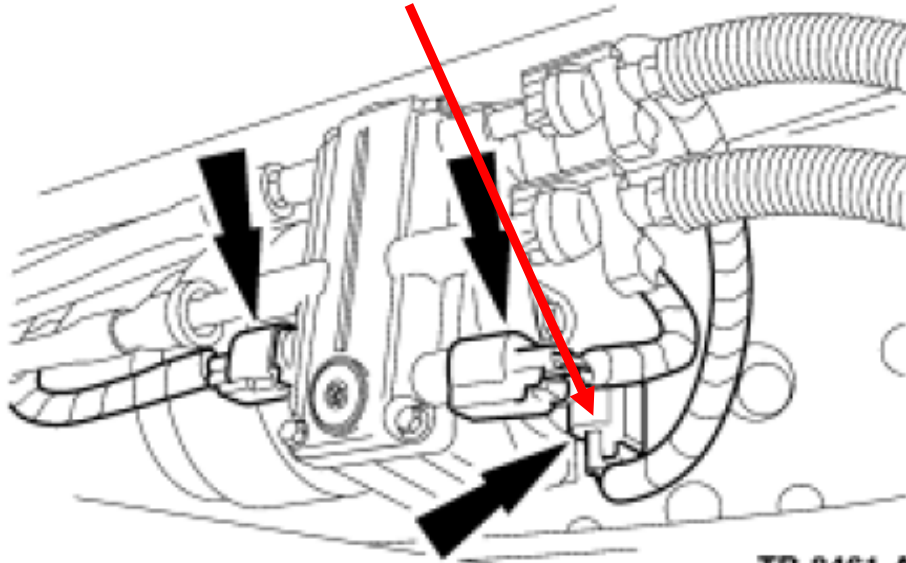

TB-8461-A



STEP 3: **MOUNT FUEL SYSTEM**

F. Position the PBR-2001 to the PFB-2002 pump assembly at the mounting location and check for fit. Once location is established mark location for mounting in next step.



STEP 3: **MOUNT FUEL SYSTEM**

G. Assemble the FASS pump bracket PBR-2001 using the RS-2002 spacer between PFB-2002 and PBR-2001 bracket with 4-3/8 bolts, nuts, and washers. Note: Torque bolts not flange nut.

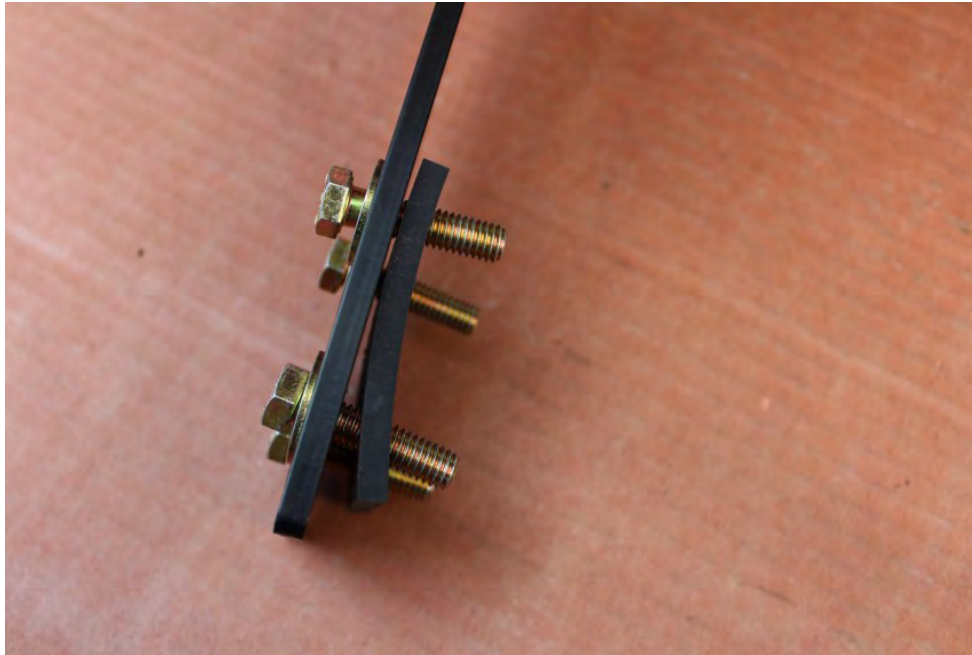

STEP 3: **MOUNT FUEL SYSTEM**

H. Once secure use 3-11/2 bolts and 3-WA-1001D spacers to mount the pump to the bracket.

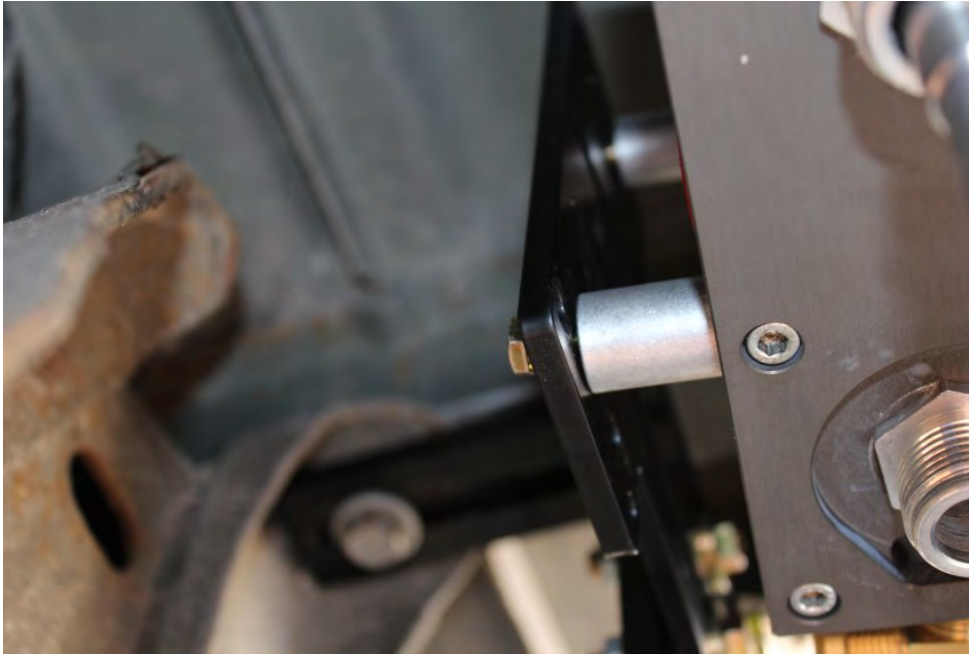

STEP 3: **MOUNT FUEL SYSTEM**

I. Connect female plug of the FASS harness into pump. Turn key to "on". With pump operating (you may have to bump the starter), turn pump over, liberally spray WD-40 (or equivalent) into water separator nipple lubricating Gerotor.

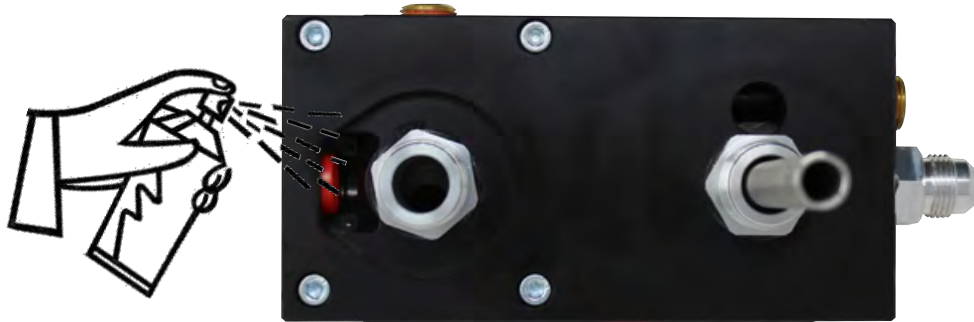

STEP 3: MOUNT FUEL SYSTEM

NOTE: If fuel pressure gauge is pulsating after FASS installation, use snubber valve (Cat Part # 7S-3795)

- J. Apply motor oil to gasket located on filters. Attach to system and hand tighten.



Extreme Water Separator - Install XWS-3002 on side of pump with draw tube in the middle of the filter nipple.



Particulate Filter - Install PF-3001 on filter nipple without the draw tube. Make sure to insert O-Ring provided on nipple.



Note: O-Ring must be put back on suction side of pump. Failure to do so can result in priming issues, cavitation or pressure losses.

STEP 4: **INSTALL FUEL LINE**

NOTE: Hose clamps are not recommended for push lock fittings. They will hold up to 300psi! Use oil on fittings and inside fuel line when installing Push-Lok fittings

A. Route suction line from the suction tube to the 'T' port of the FASS pump. Cut FL-1058-BK to length.(measure twice cut once) Insert PL-2058-BK using oil. Attach to AN-10-ORB-10-BK and tighten accordingly.

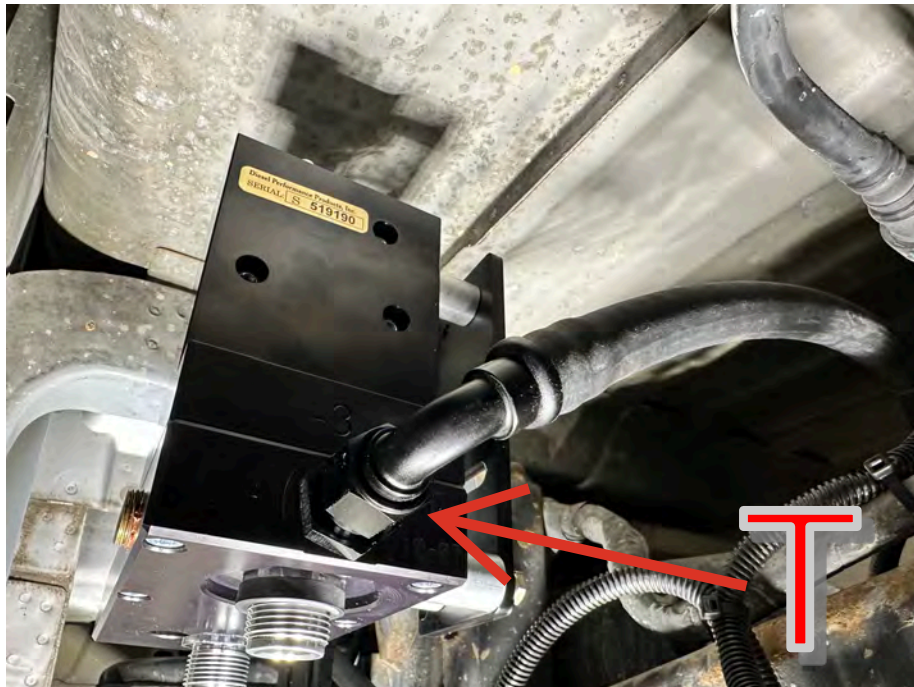

STEP 4: **INSTALL FUEL LINE**

B. Route fuel line from the 'R' port of the suction tube to the 'R' port on the FASS system with a gentle bend. Cut and insert the PL-1005-BK fitting in the hose using oil. Attach fitting to the 'R' port. and tighten accordingly.

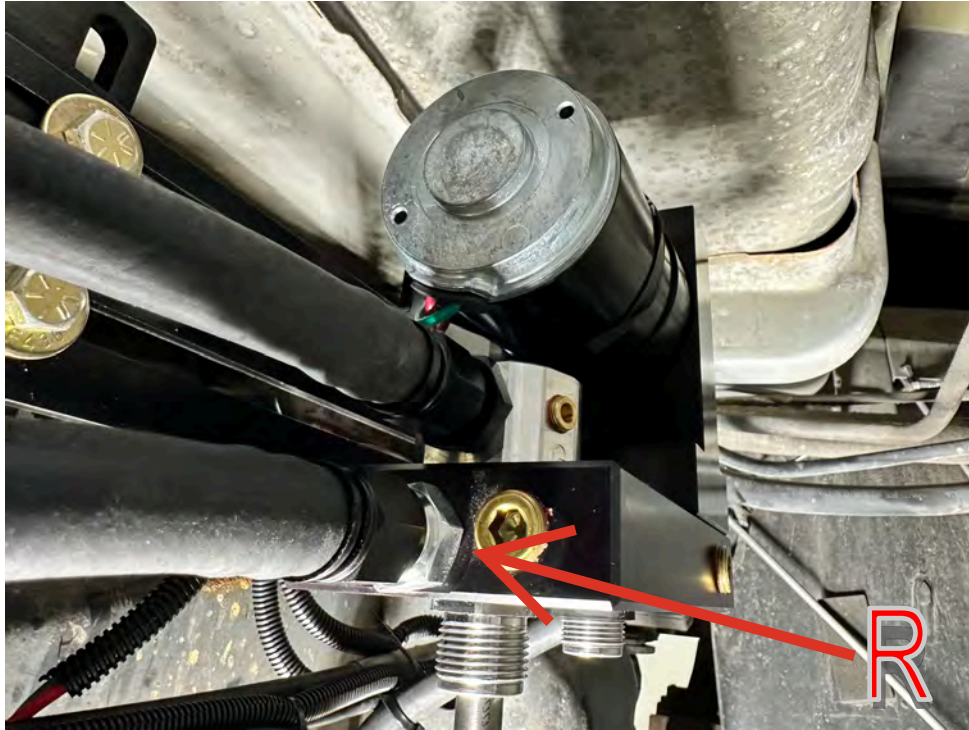

STEP 4: **INSTALL FUEL LINE**

C. Insert PL-1005-BK into remaining fuel line using oil. Attach fuel line to the 'E' port of the FASS system. Torque to 18 ft./lbs. Route this line to the engine side of the factory lift pump. Do not cut at this time.

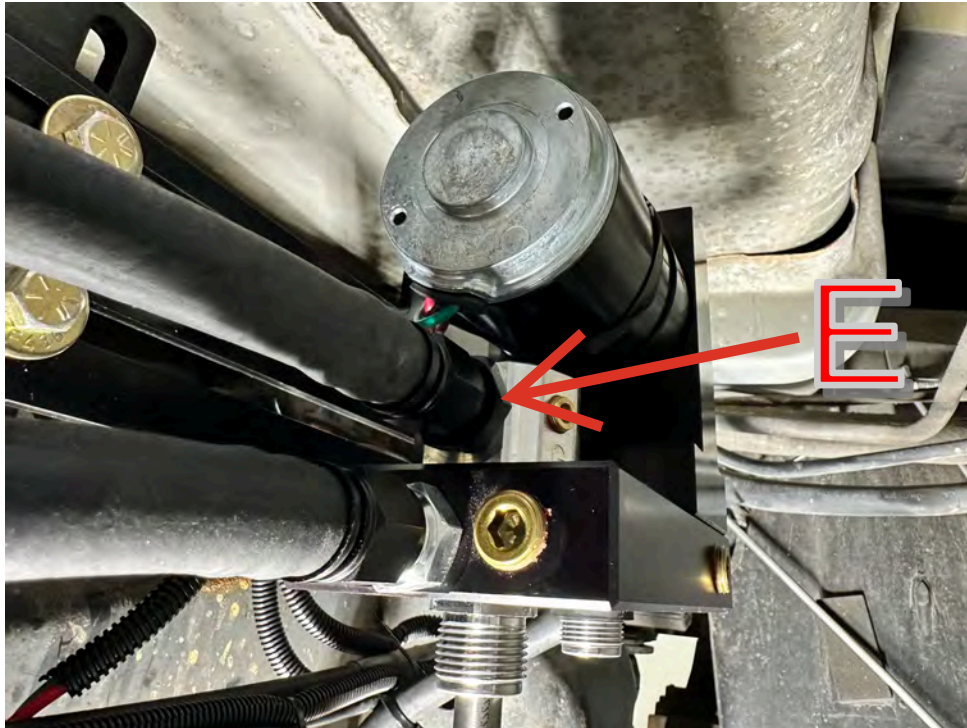

STEP 4: **INSTALL FUEL LINE**

- D. Bypass factory fuel pump.



STEP 4:
INSTALL FUEL LINE
1999-2003 with 7.3L Powerstroke

E. Using a quick disconnect tool, remove the outlet side of the factory fuel pump. The factory return line on the 7.3L does not require any modification. Route the fuel line from the "E" port of the FASS to the factory lift pump's quick disconnect and cut to length. Insert the PLB-12516 into FASS fuel line using oil. Slide the PLB-12516 into the factory quick disconnect until you hear a click. Lock down factory retainer clip.



F. Disconnect the OEM feed line from the fuel pump inlet. Install QC-PLUG-516 into the fuel line.



STEP 4:
INSTALL FUEL LINE
2003-2007 WITH 6.0L POWERSTROKE

- D.** Drain fuel from factory pump/filter using a 6mm hex drive, turning it counterclockwise.



STEP 4: INSTALL FUEL LINE

E. Using quick disconnect tools, remove the fuel lines from the front of the factory fuel pump. Remove the fuel lines attached to the rear of the factory fuel pump by pressing in on the tabs

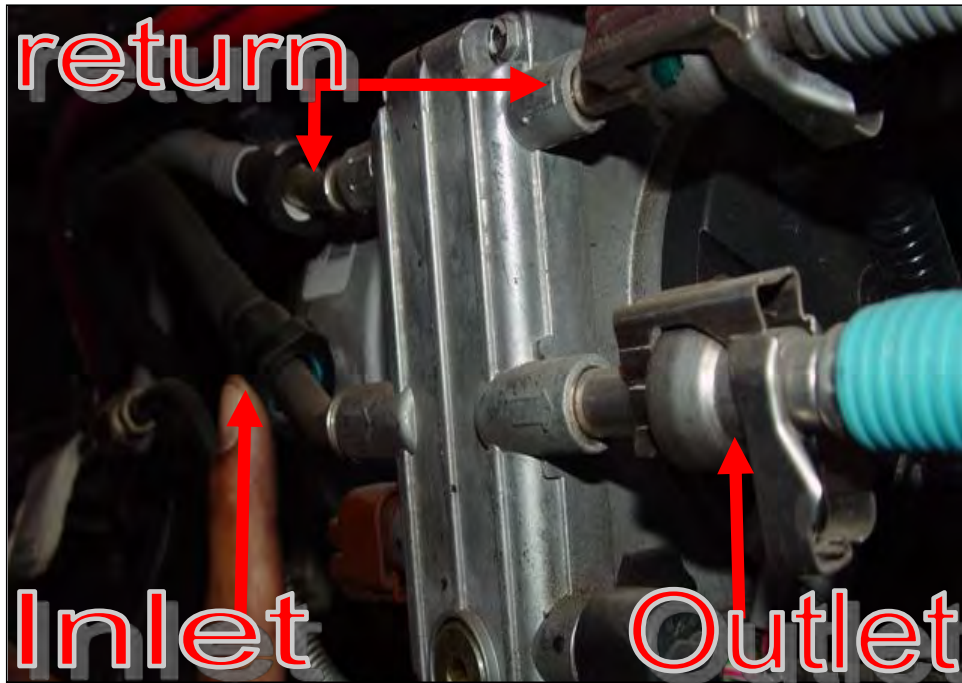

STEP 4: INSTALL FUEL LINE

- F. Disconnect the OEM engine feed line from the inlet of the fuel pump/filter assembly. Install QC-PLUG-38 into the OEM fuel line.

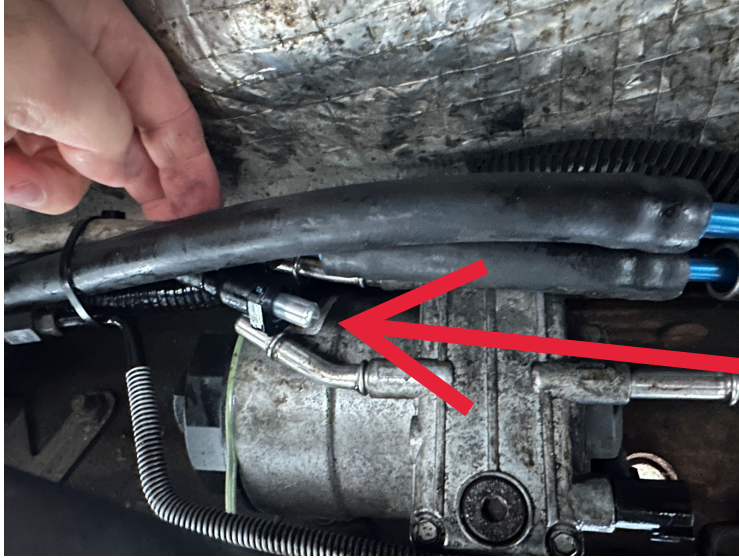

STEP 4: INSTALL FUEL LINE

NOTE: Secure all fuel lines with cable ties. Cable ties are an economical way to prevent the possibility of problems occurring!

G. Route the fuel line from the “E” port of the FASS to the factory lift pump’s outlet quick disconnect and cut to length. Insert the PLB-1238 into FASS fuel line using oil. Slide the PLB-1238 into the factory quick disconnect until you hear a click. Lock down factory retainer clip.



STEP 4: **INSTALL FUEL LINE**

H. Measure between the two factory return fittings. Insert two PLB-12516 fittings into the provided FL-1002-BK fuel line using oil. Insert fuel line into factory quick disconnects until you hear a click. Lock down retainer clip. Secure fuel line.



STEP 5: **REVIEW INSTALLATION**

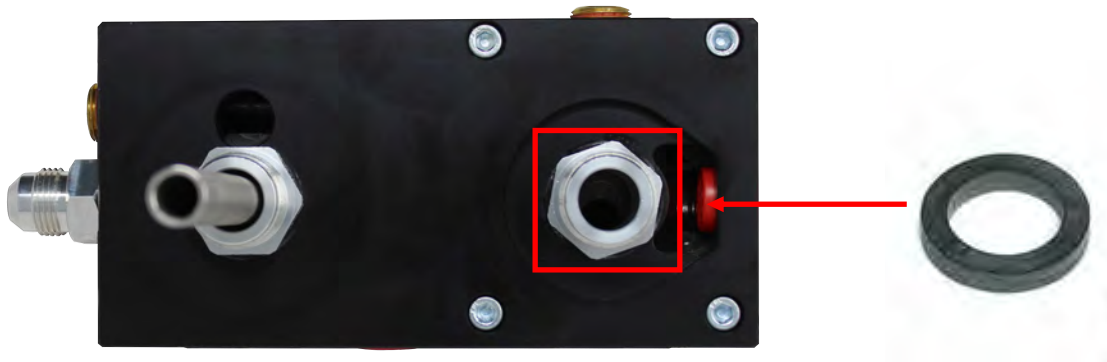

Note: O-Ring must be put back on suction side of pump. Failure to do so can result in priming issues, cavitation, or pressure losses.

1. **Blow out any open lines/cover any open ports**
2. **Bolts and fasteners properly tightened?**
3. **Electrical harness and fuel lines secured and properly tightened? Reconnect the battery.**
4. **Has the system been primed?**
 - a. **Turn key to the ignition position, turning on the FASS pump for 15 sec..**
 - b. **Crank engine and allow to run for at least 1 minute.**
5. **Check for leaks.**
6. **Start the engine**
7. **Recheck all fluid and filter connections for leaks**
8. **This pump comes with a 1 Year Manufacturer's Warranty based on the date it has been manufactured. To receive your extended Lifetime Warranty, you have 30 days from date of purchase to send the completed warranty information**



LIMITATION OF LIFETIME WARRANTY

Disclaimer: To help insure you receive the proper system and customer support at the local level, FASS has a VIP and Authorized Dealer network representing FASS products. This is one reason you must purchase through a dealer to comply with our warranty policies. If you do not, there is no warranty! We recommend you go to www.FASSride.com, click "Find a Dealer", put in their ZIP code, select the type of dealer, and see if the company you purchased from is listed. If they are not, put their phone number in the field below the ZIP code field to see if they are listed. Below these two fields is a list of "Terminated/Unauthorized" dealers. You may want to review this list. If the company is not listed or is on the "Terminated/Unauthorized" list, we suggest you return the product immediately to that dealer and call FASS. We'll recommend you to the nearest dealer.

Diesel Performance Products, Inc. (hereafter "SELLER") gives Limited Warranty as to description, quality, merchantability, fitness for any product's purpose, productiveness, or any other matter of SELLER'S product sold herewith. The SELLER shall be in no way responsible for the product's open use and service and the BUYER hereby waives all rights other than those expressly written herein. This Warranty shall not be extended or varied except by a written instrument signed by SELLER and BUYER.

When MANUFACTURER receives the "ORIGINAL" PRODUCT REGISTRATION form with a copy of the "BILL OF SALE/SALES RECEIPT" within 30 days of the sale, then the following applies! The Warranty will then and only then be validated to that of which typically accompanies your unit for your specific application from the date of sale or for recommended service life and limited solely to the original purchaser and/or vehicle and parts contained within the product's kit. This warranty does not cover normal wear on consumable items such as but not limited to filters, fuel line, wire harness & etc. The warranty does not cover seized gears due to lack of filtration. Warranty is voided if used with other than diesel fuel. Returned items will arrive prepaid to the place of purchase. Diesel Performance Products, Inc. will repair, without cost, any product found to be defective during the warranty period; parts only, or at its option, will replace such products in exchange for the product. Repair or replacements are warranted for the remainder of the original warranty period. All Warranty claims are subject to approval by Diesel Performance Products, Inc.

A Return Material Authorization (RMA) number must be obtained before any product is to be returned to Diesel Performance Products, Inc. for warranty consideration, repair or product return. Requests for product returns must be offset by an equal value order. Return parts must be completed and in resalable condition. No returns after 30 days.

The following information is required to obtain a RMA number before returning product:

Your Name, Address, and Phone Number's

Model and Serial Number (Not Motor Number) Example: Model HD Series, Serial: 00125966 VIN Number of Vehicle

Date of Purchase

Nature of Problem

RMA and Product Serial Number must be on all paperwork and correspondence. Failure to obtain the required information or paperwork will result in \$25.00/item penalty and delay or denial of any warranty claim.

Under no circumstances shall the SELLER and/or MANUFACTURER be liable for any labor charged or travel time incurred in diagnosis for defects, removal, or reinstallation of this product, or any other contingent expenses.

Under no circumstances shall the SELLER and/or MANUFACTURER be liable for any damage or expenses insured by reason of the use or sale of any such equipment. This warranty does not apply to products which Diesel Performance Products, Inc. has determined to have been misused or abused, improperly maintained by the user, or where the malfunction or defect can be attributed to the use of non-genuine Diesel Performance Products, Inc. parts.

IN THE EVENT THAT THE BUYER DOES NOT AGREE WITH THIS AGREEMENT: THE BUYER MAY PROMPTLY RETURN THIS PRODUCT, IN A NEW AND UNUSED CONDITION, WITH A DATED PROOF OF PURCHASE, TO THE PLACE OF PURCHASE WITHIN THIRTY (30) DAYS FROM DATE OF PURCHASE FOR A FULL REFUND LESS SHIPPING.

THE INSTALLATION OF THIS PRODUCT INDICATES THAT THE BUYER HAS READ AND UNDERSTANDS THIS AGREEMENT AND ACCEPTS ITS TERMS AND CONDITIONS.