

INSTALLATION INSTRUCTIONS
Heater Kit: for Can-Am Defender

- Do not discard packaging until product has been successfully installed.
- SKU HTR-CA-DEF shown in installation illustrations.

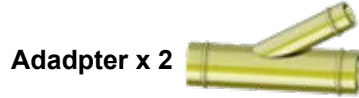

Dash Bracket

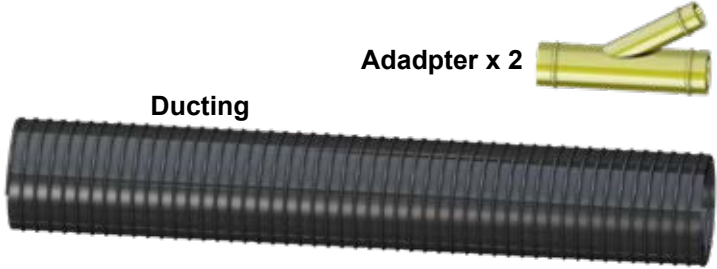
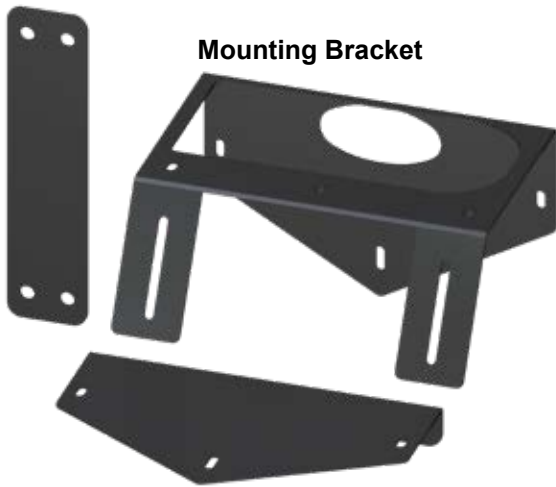

(kit contents continue on following page)

Need help with your installation?

 sales@superatv.com
 www.superatv.com

 1-855-743-3427
  8:00am - 8:00pm EST M-Th
 8:00am - 7:00pm EST Friday
 9:00am - 2:00pm EST Saturday

Read instructions and view illustrations before beginning.

Thank You
For Choosing
SUPERATV.COM[®]

(kit contents continued)

SKU HTR-CA-DEF Heater



SKU HTR-CA-DEF-001 Heater



- Tubing and Duct lengths are SuperATV recommended. User may install components in other locations. Verify lengths before final installation.
- Check behind areas being drilled for interference.
- Avoid burns and scalding by working on cool vehicles.
- Secure components away from rotating objects.
- Do not tighten mounting hardware until all components are in place.
- Use manufacturers recommended coolant.
- Avoid sharp bends when installing Tubing.
- Verify that no leaks are present after installation.



Verify wiring shown below is connected before installing.

- Open Vent, insert finger, and pull Controls away from Base.



- If not connected, connect orange wire to Tab shown.

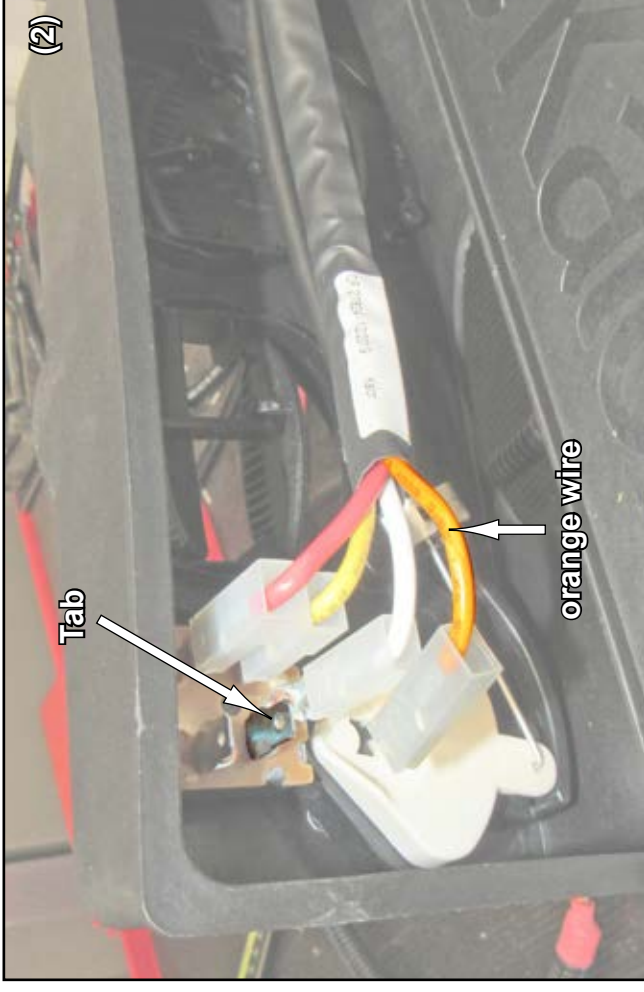

- Verify that all connections shown are connected and secure.
- Push Controls back into Base.

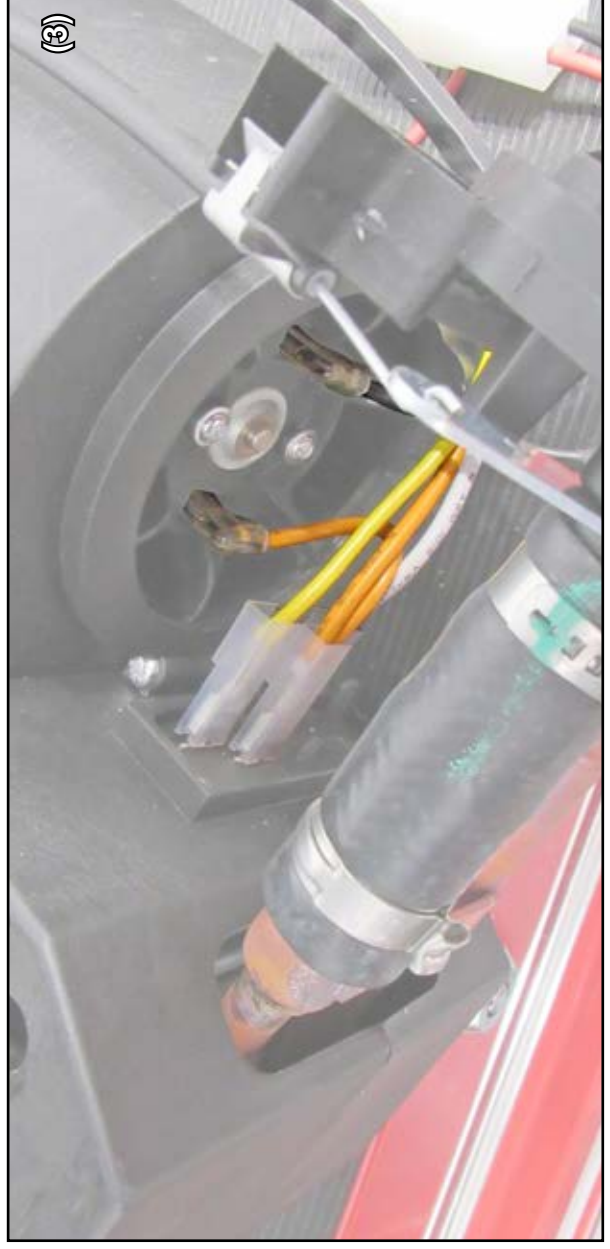

- Remove Front Bulkhead Cover.

2020 MODELS BULKHEAD LOOK DIFFERENT



- Remove Lower Dash.



- Remove Battery Cover.

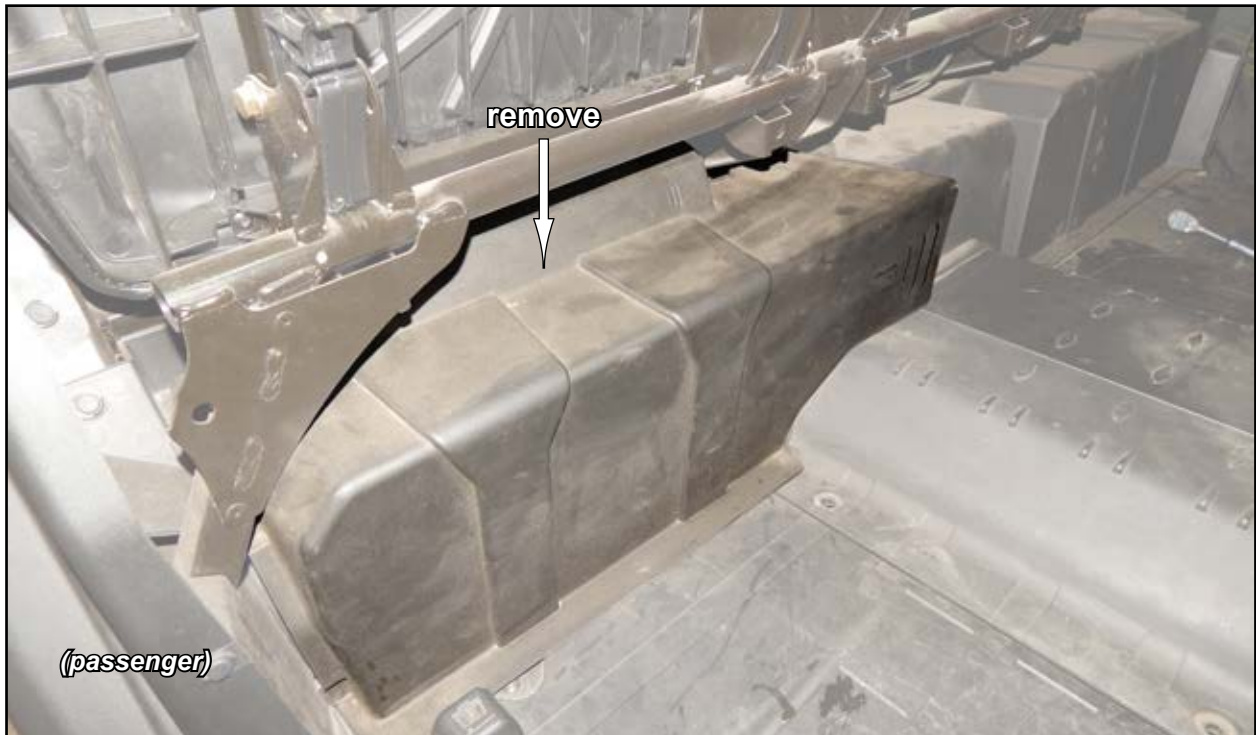

- Remove Floor Cover.



2020 MODELS SEE PAGE 21

Mounting Bracket

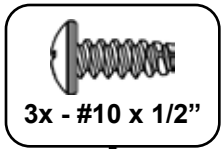

install Bracket to Heater with hardware shown

Heater

3 each

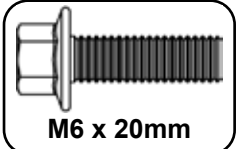

M6 x 20mm

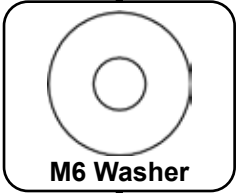

M6 Washer



M6 Nut

Defrost Bracket

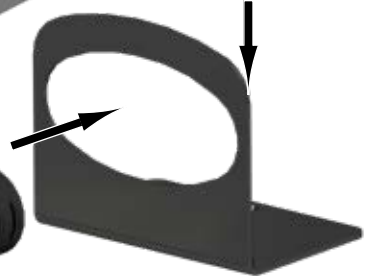

insert Elbow into opening in Heater

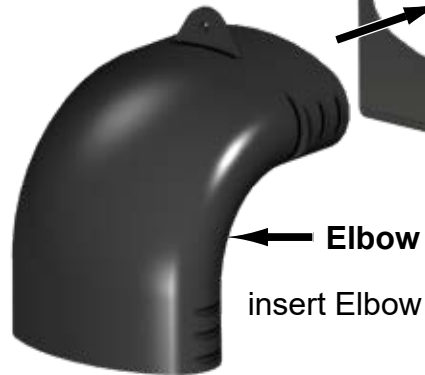

Elbow

insert Elbow into Defrost Bracket

secure Brackets with hardware shown

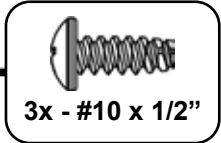

3x - #10 x 1/2"

plug Wire Harness into Motor

Template

- Follow profile and cut template.
- Attach to location shown with tape. See page 9.
- Mark centers, remove, and use provided $\text{\O}1\text{-}1/4\text{'}$ Hole Saw to make holes.

2020 MODELS SEE PAGE 22

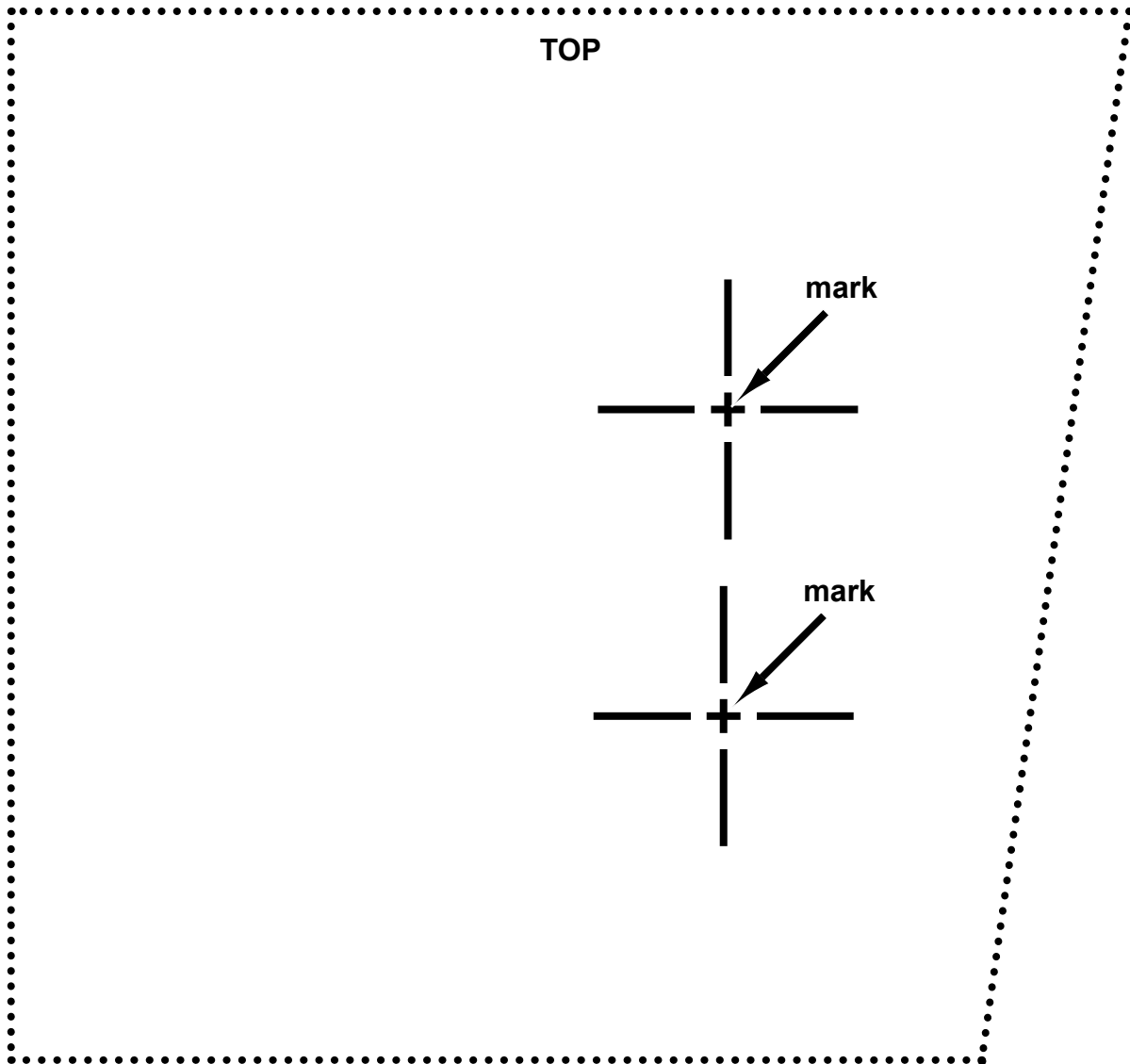

this page intentionally blank

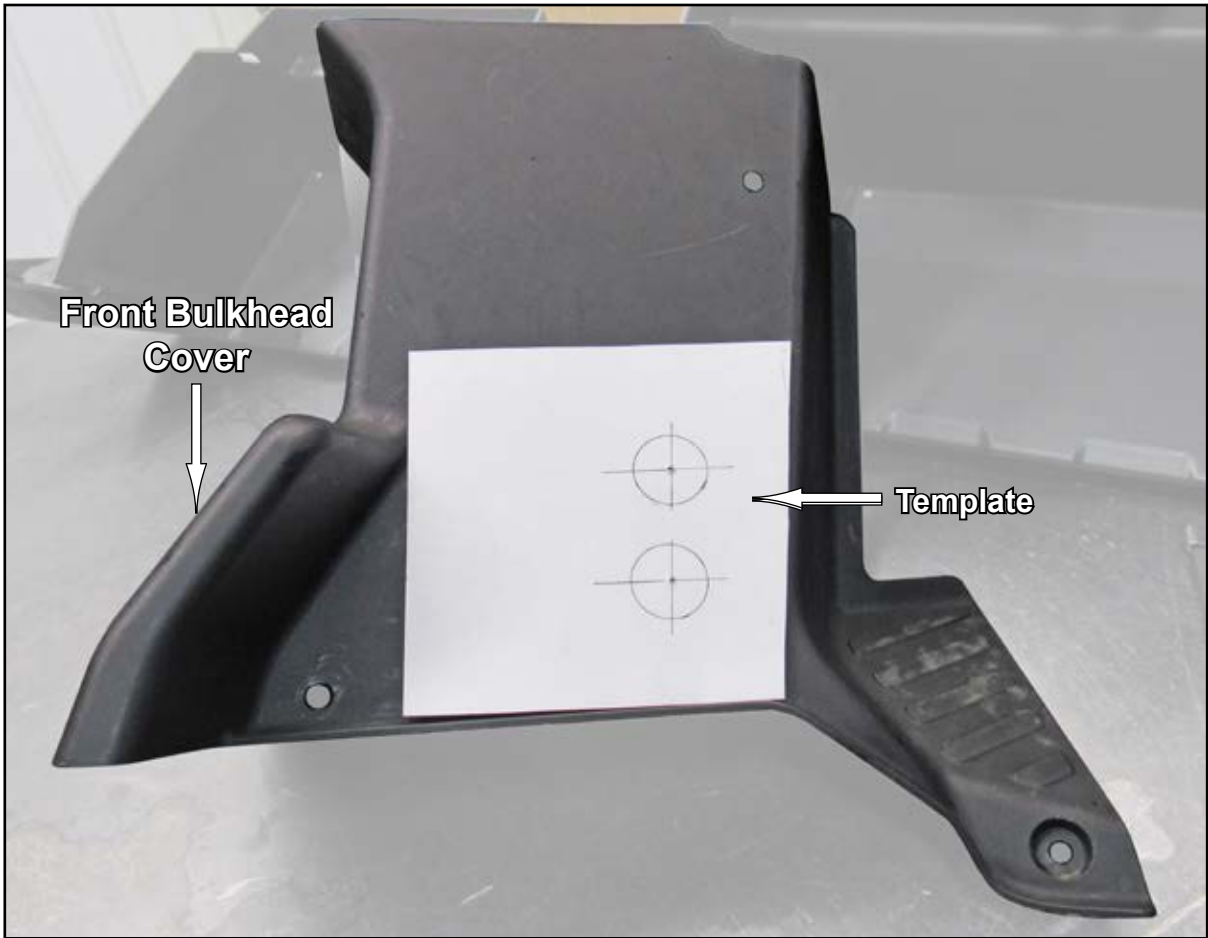

- Place Mounting Bracket on Dash and center side-to-side.
- Mark (2) mounting holes; drill holes large enough for 6mm bolts.

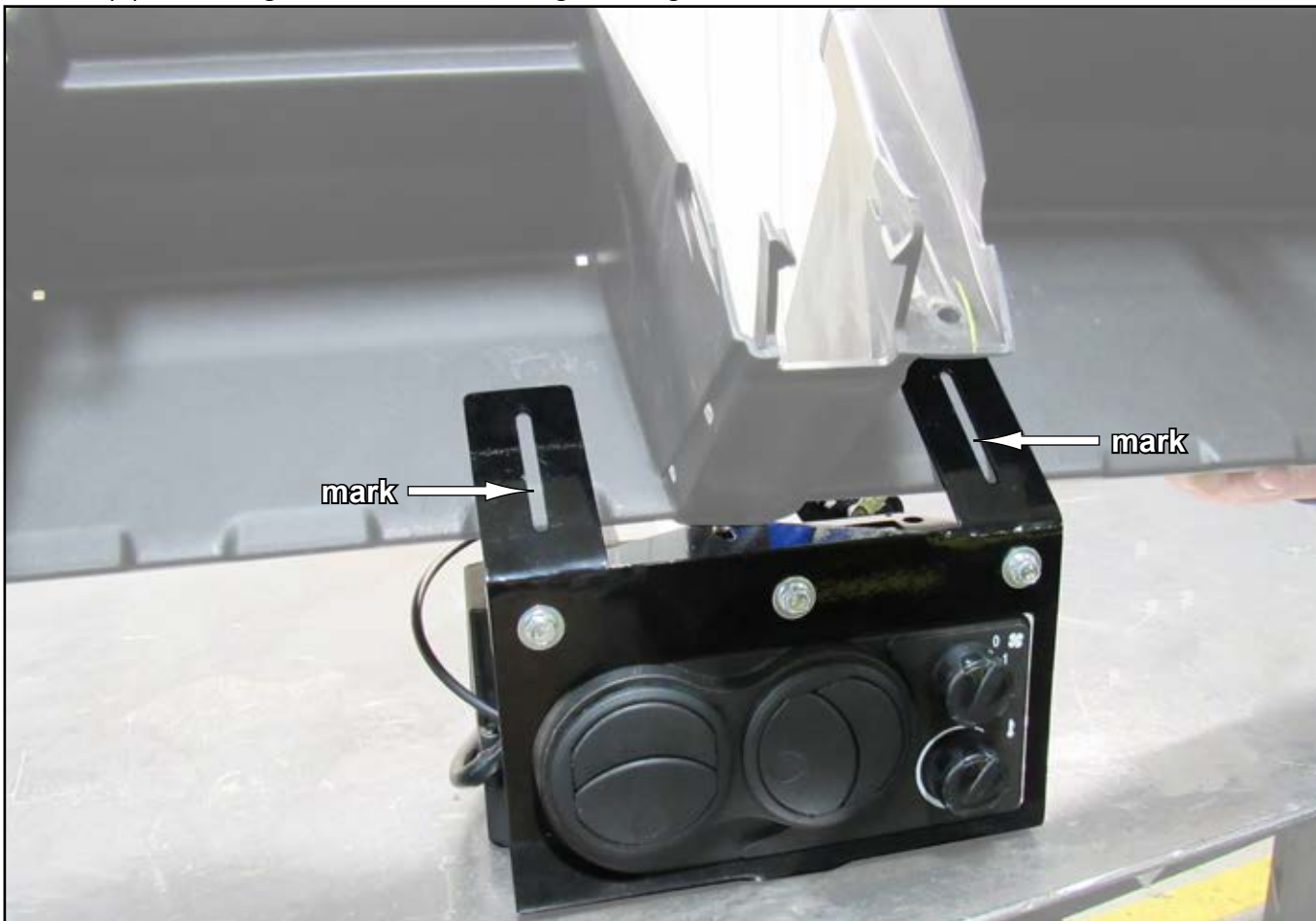

- Place Dash Bracket *inside* Dash and temporarily secure Brackets with hardware shown.
- Mark remaining (2) mounting holes, remove components, and drill. Set components aside.

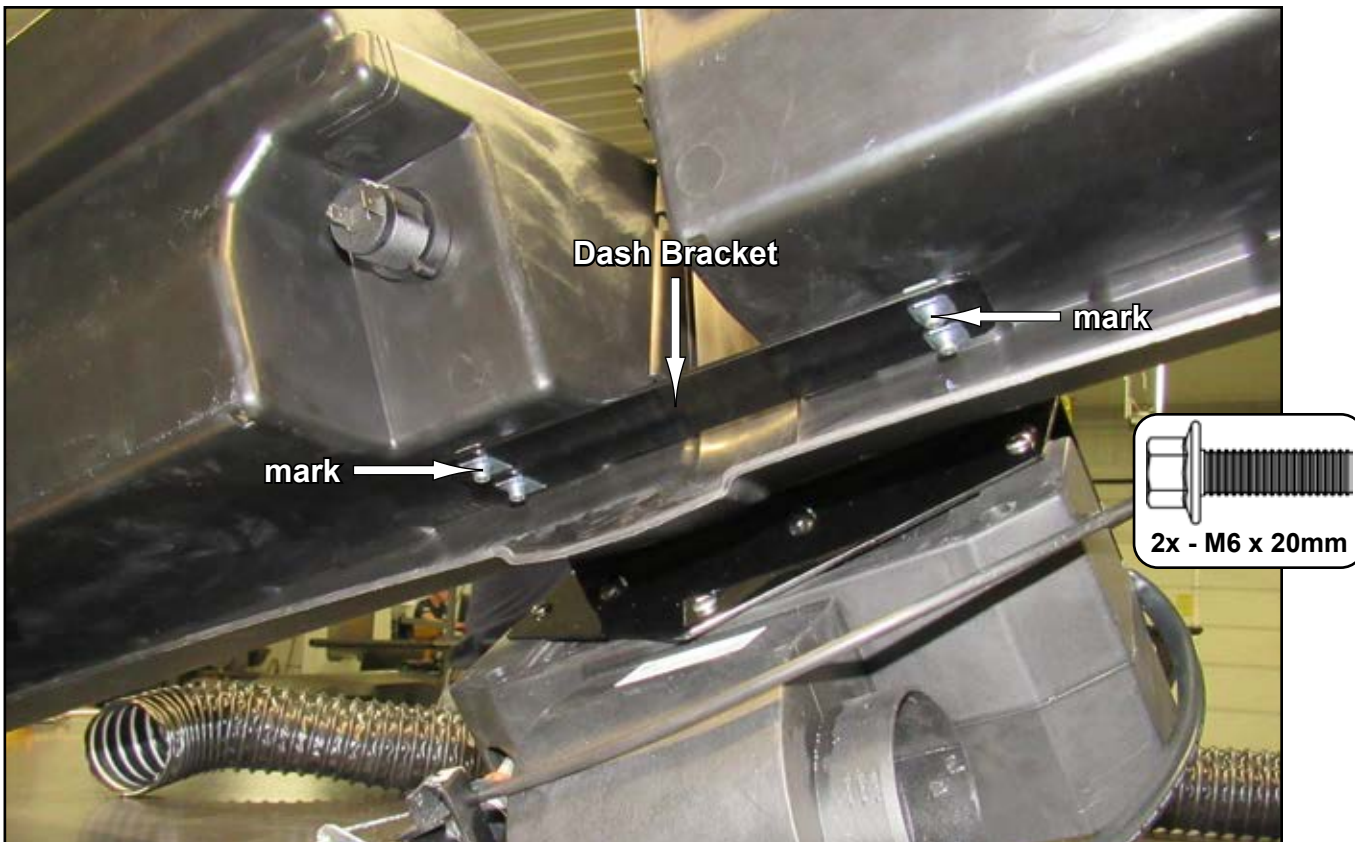

- Mark locations for Vent and use provided Ø2-1/2" Hole Saw to make hole.
- *Installer may locate Vent in a different location. Verify that Ducting will reach before drilling hole.*



- Route Duct into Dash and up to previously cut hole.



- Separate Vent and secure lower portion to Duct with provided Wire Tie.



- Secure top portion of Vent to lower.



- Raise front of vehicle and place on jack stands.
- Remove Lower Radiator Hose and drain coolant.

To prevent stock Radiator Hoses from being cut short, use provided Adapters as templates.

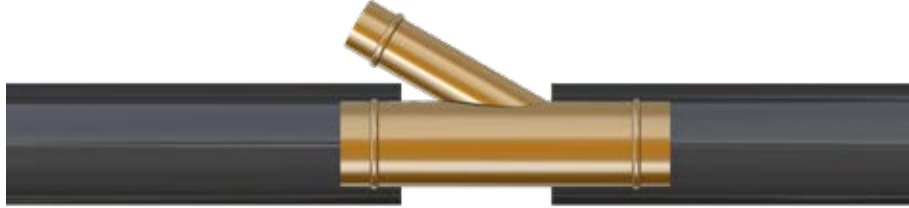

- Cut supplied Hoses to shown lengths and attach to provided Adapters.
- Hold up to stock Hoses and mark locations to be cut.
- Cut stock Hoses and install Adapters with Clamps as shown.

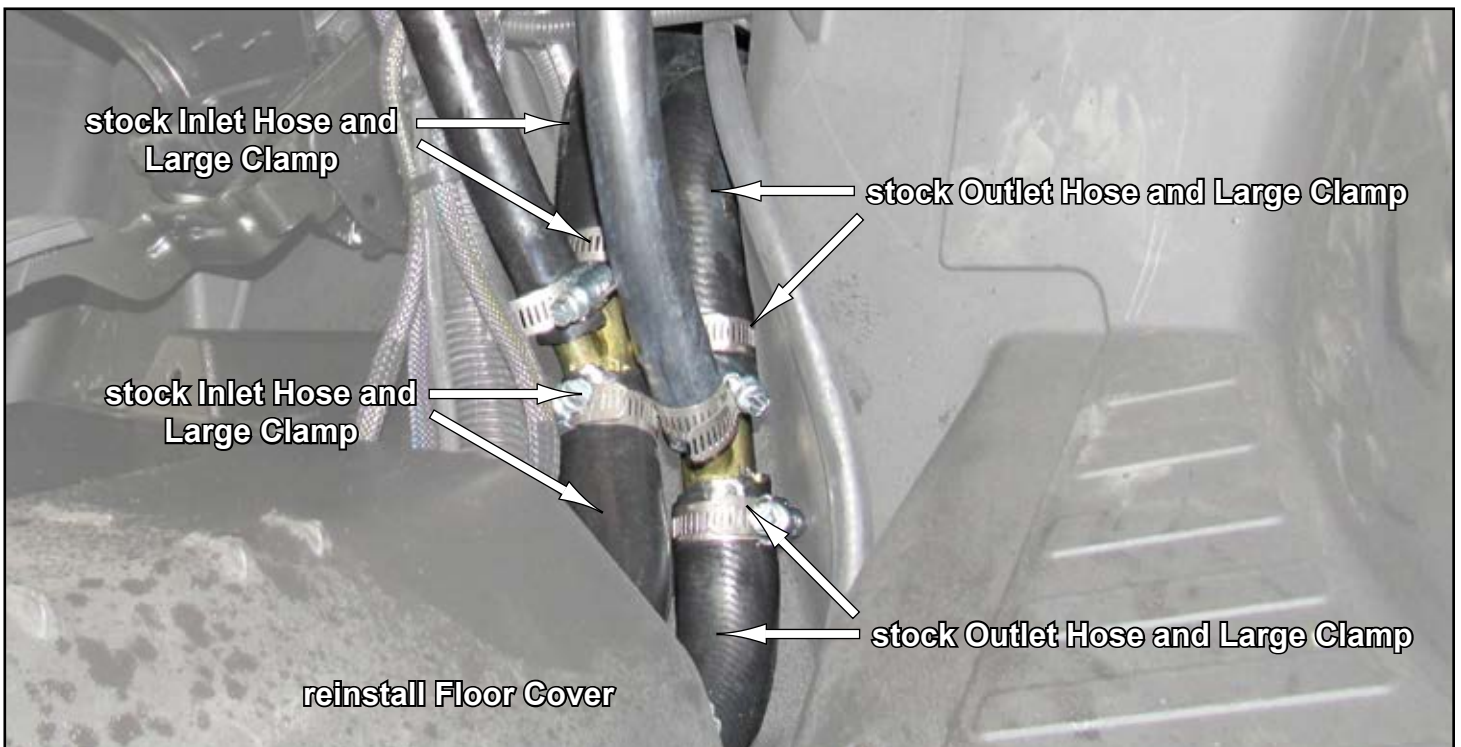
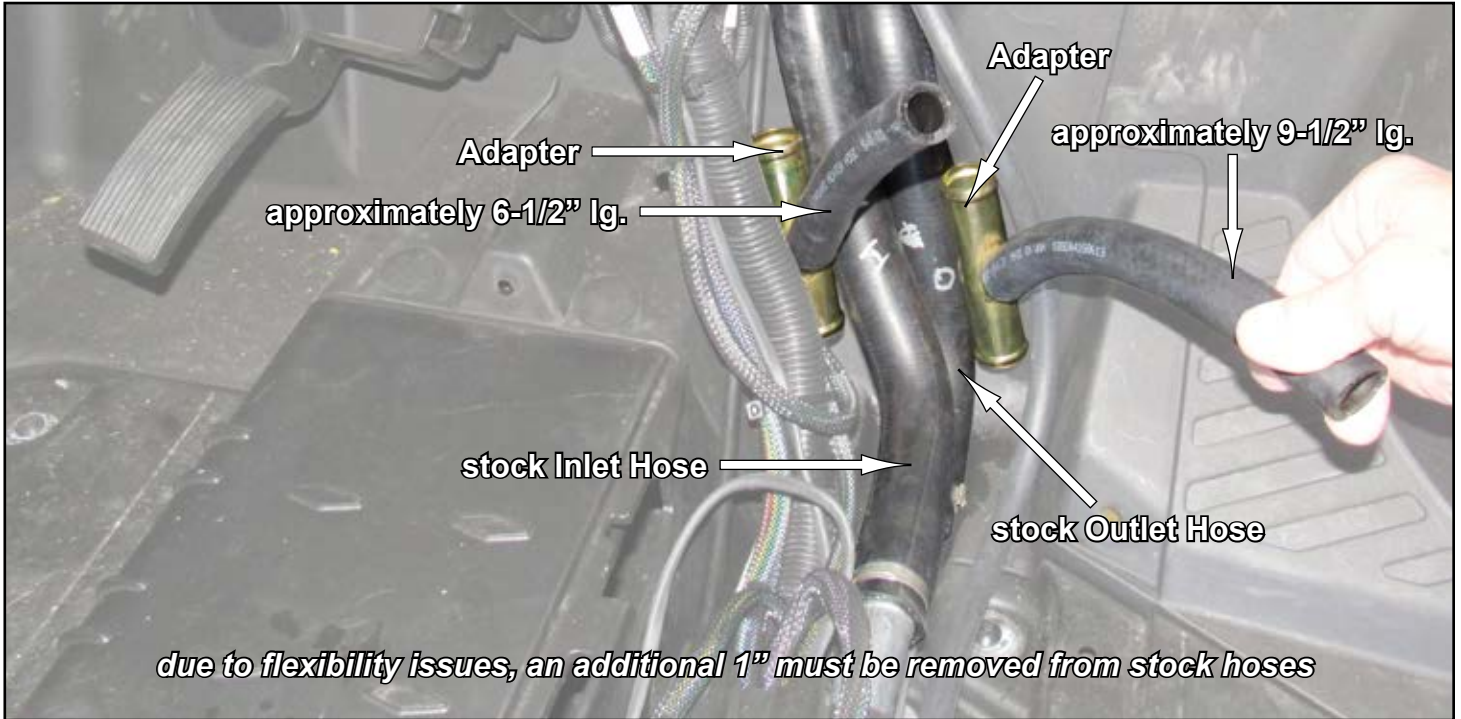

- Reinstall Dash, Battery Cover, Floor Cover, and Bulkhead Cover.

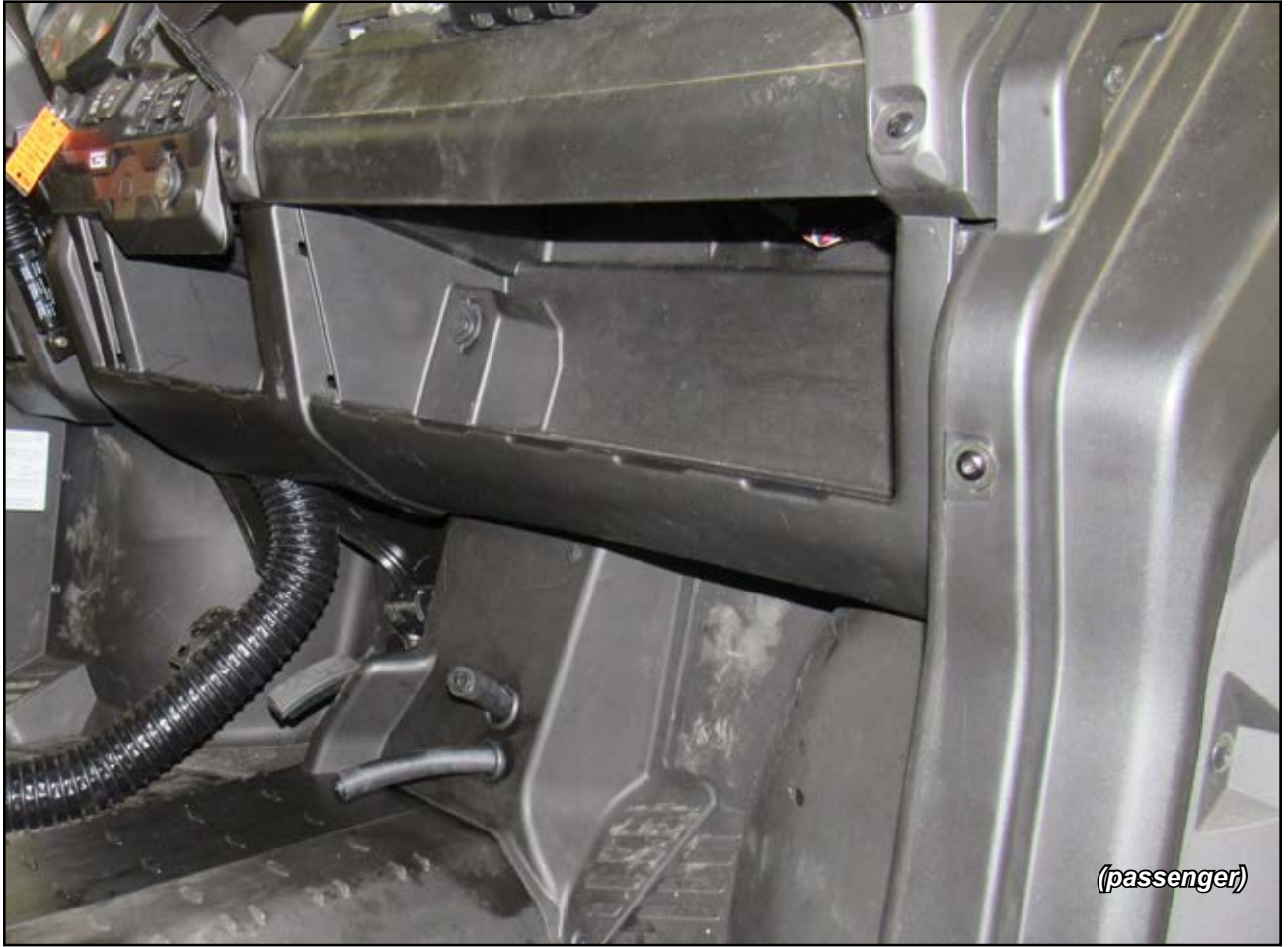

- Route Duct behind plastic to middle of Dash.



- Place Mounting Bracket onto Dash and connect Hoses as shown.

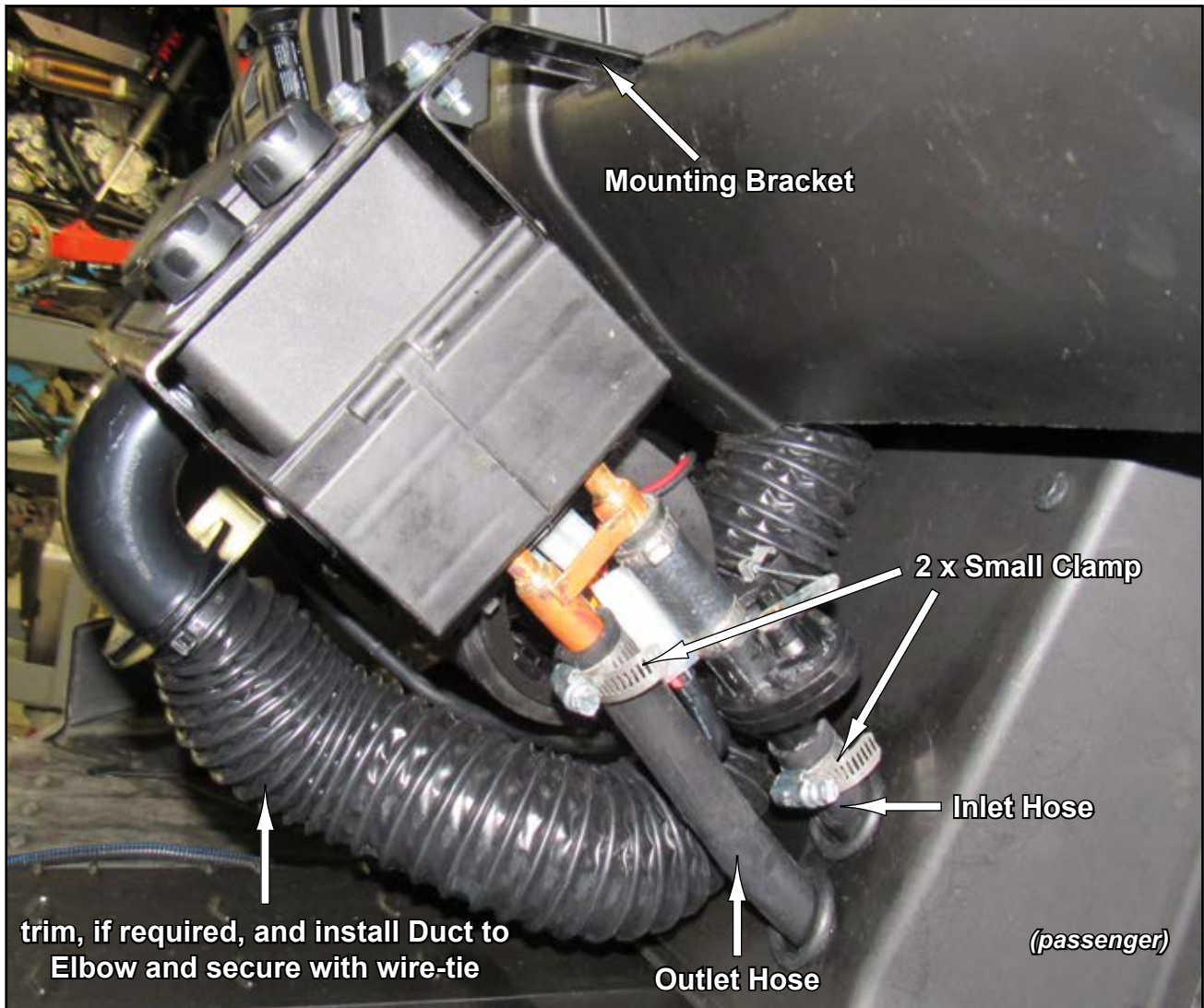



- Secure Mounting Bracket to Dash Bracket with hardware shown. *Dash Bracket installs inside Dash.*

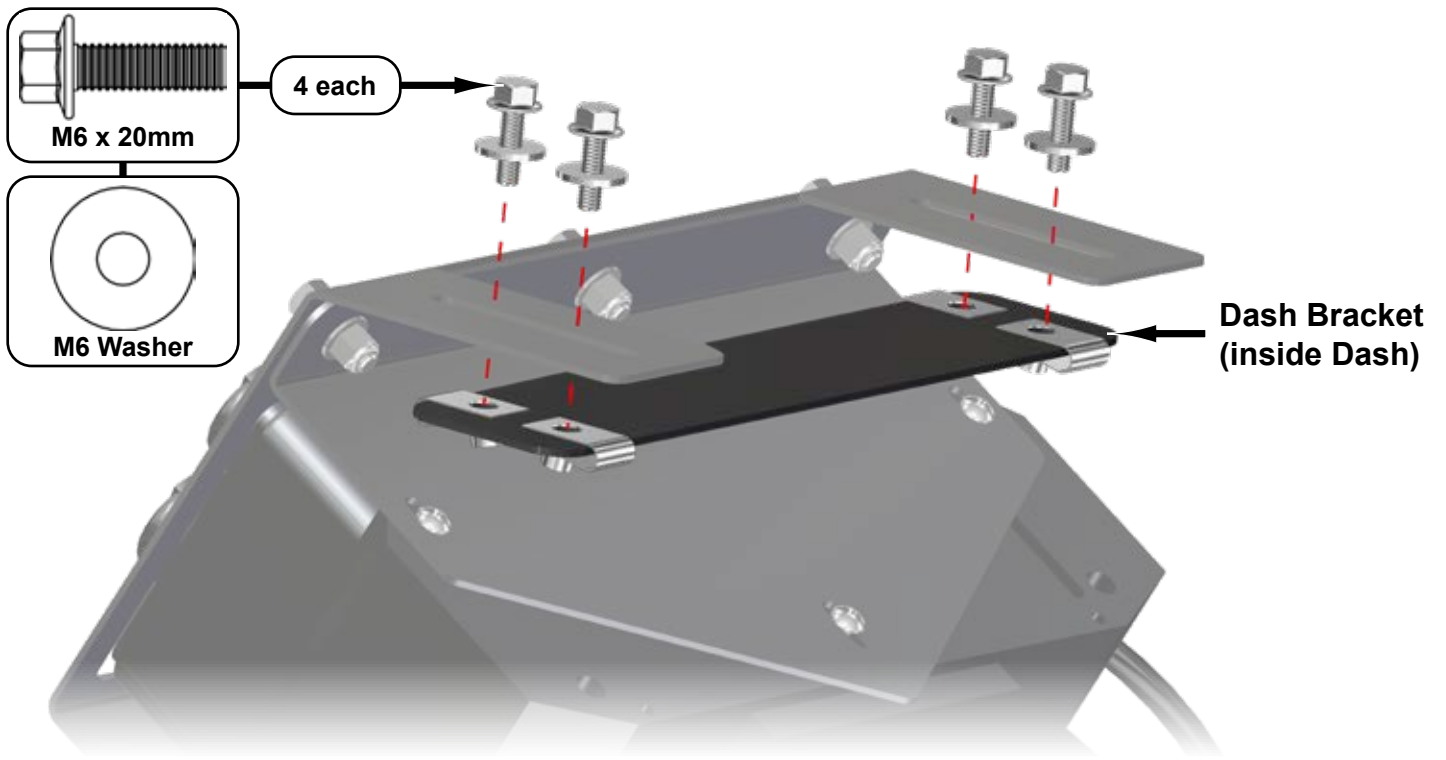

Power Connections:

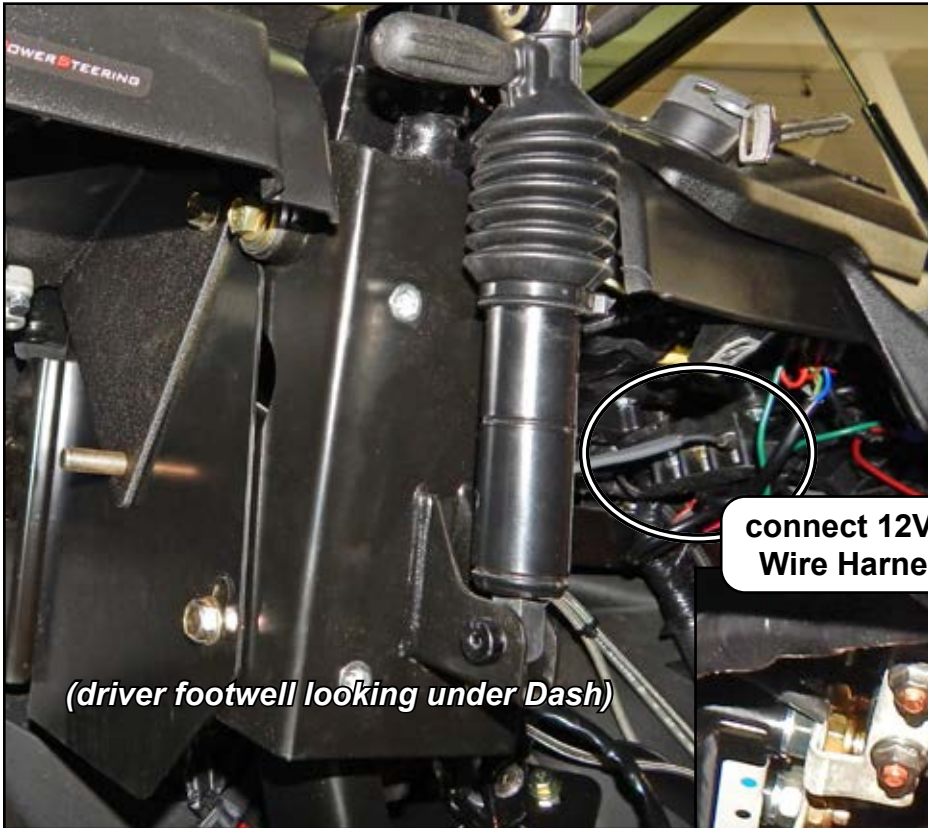

(driver footwell looking under Dash)

connect 12V and Ground wires from Wire Harness to ACC Power Block

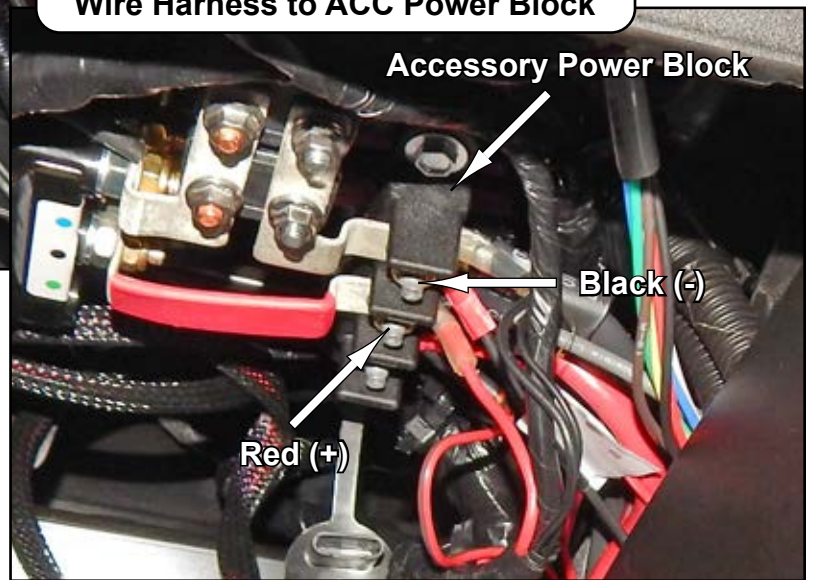

Accessory Power Block

Red (+)

Black (-)

Power Connections for 2020+ models:

- connect 12V and Ground wires from Wire Harness
- secure with hardware shown

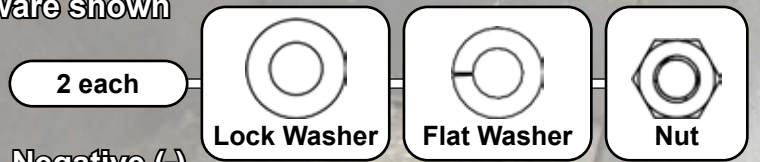

Negative (-)

Positive (+)

Accessory Power Block



- Place machine back on ground.
- Fill coolant level to manufacturers recommended setting.
- Start machine and run at 3000 RPM until engine is hot.
- Use provided Hose Pliers and pinch off Inlet Hose as shown below.

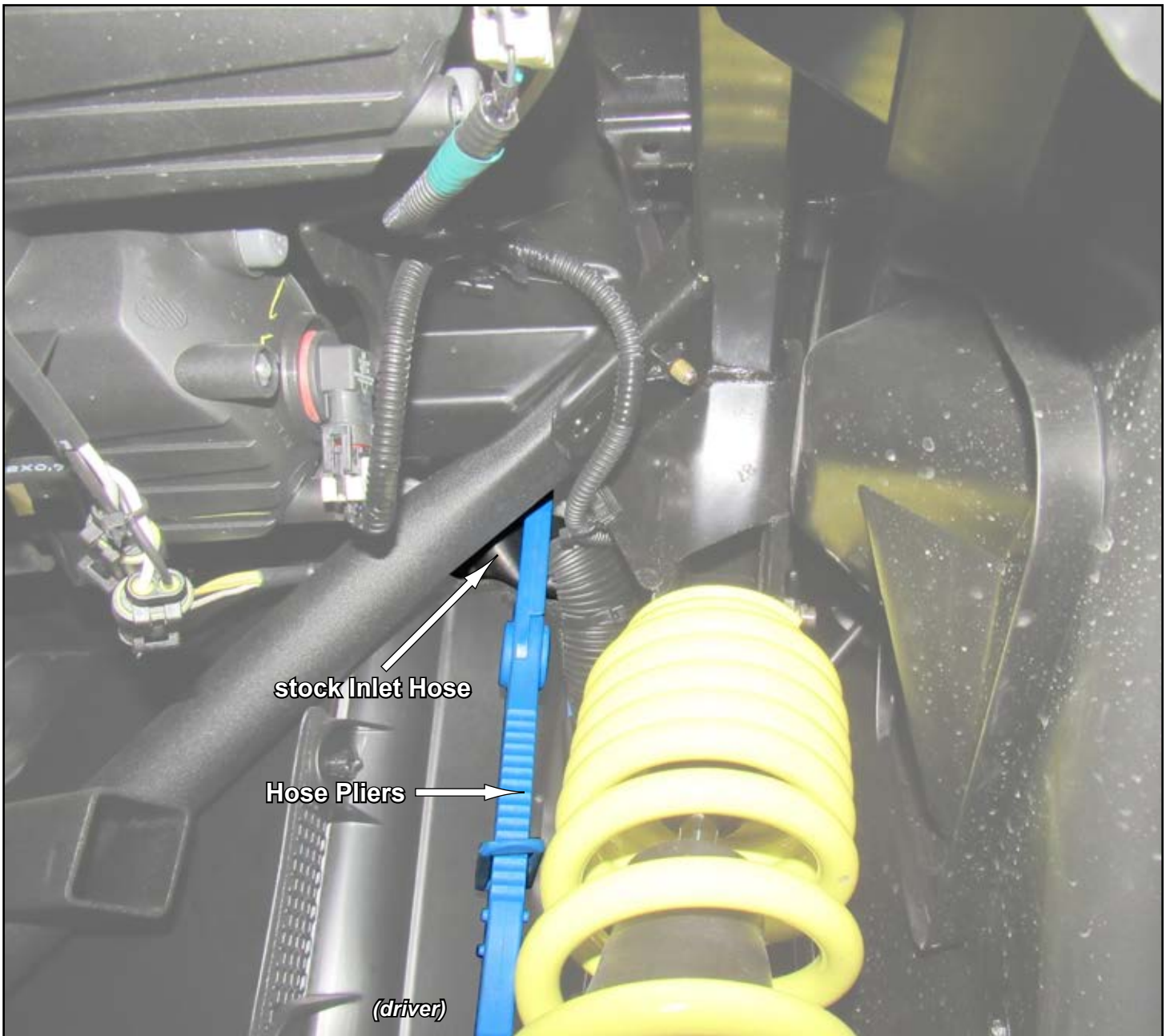

- Remove Hose Pliers after Radiator Fan turns ON.
- After Radiator Fan turns OFF, pinch Inlet Hose again and remove after Radiator Fan turns ON.
- Turn machine off and let engine completely cool; may take several hours.
- Check Coolant Level in Radiator and Reservoir; adjust as needed.
- Start machine and repeat “pinch” steps again.

2020 Models



2020 Models

- Follow profile and cut template.
- Attach to location shown with tape.
- Mark centers, remove, and use provided $\text{Ø}1\text{-}1/4$ " Hole Saw to make holes.
- Install Grommets.

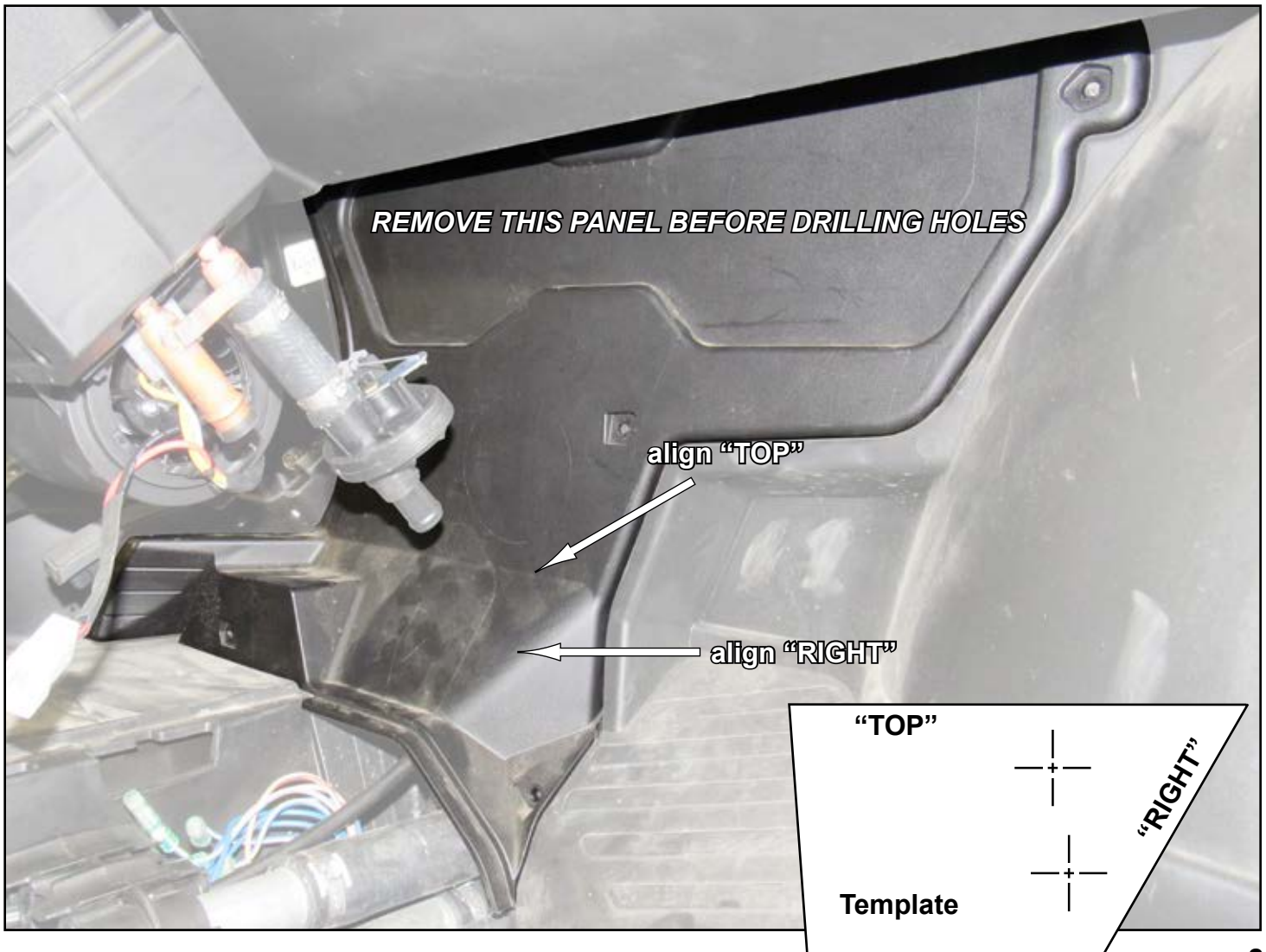
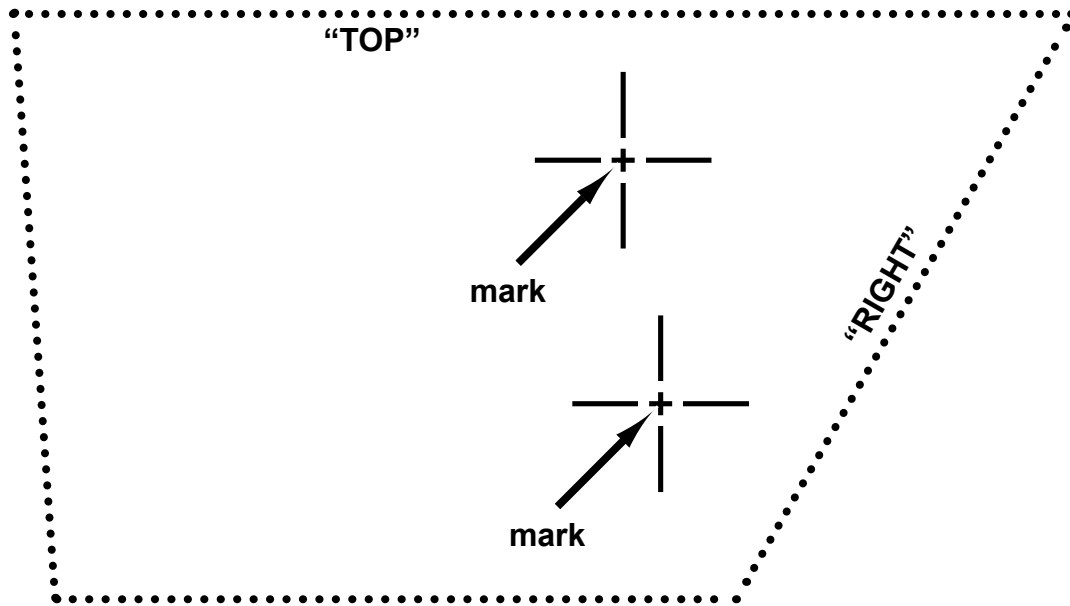

2020 Models



CUSTOMER NOTIFICATION AND DISCLAIMER LIABILITY

This product is a modification for utility task vehicles and all terrain vehicles. Use this product at your own risk.

Warranty and Liability Limitations. The Buyer hereby assumes all risks associated with the use and/or installation of this product. Buyer waives all liability claims against SuperATV® of any kind or nature, including, but not limited to, liability for penalties, fines, property damage, personal injury or death, to the fullest extent permitted by law. Buyer acknowledges and agrees that SuperATV® is not liable for any direct, indirect, incidental, consequential or special damages, including but not limited to, damage, loss of life, loss of property or equipment, loss of profits or revenue, injury, or claims from any individual or entity arising from the use of this product.

The warranty for this product, if any, may give you ("Buyer") specific legal rights, and Buyer may also have other rights which may vary from state to state. The installation of this product may void or otherwise adversely affect your factory warranty.

Consult your vehicle warranty before using this Product. Under no circumstances will SuperATV® be liable for the voidance of the Buyer's vehicle warranty. Buyer assumes all risk and responsibility if a manufacturer and/or dealer voids the Buyer's vehicle warranty due to use of this Product.

Safety and Laws. Operate your vehicle at all times in a safe manner. You must abide by all local, state, and federal laws, including but not limited to vehicle safety, traffic laws, and ordinances. It is your responsibility to know the laws and how they apply to you. The installation of this product may violate certain local, state, and federal laws. Be advised that laws vary depending on town, city, county, state, etc. Use of this product on public streets, roads, or highways may be in violation law. The Buyer is solely and exclusively legally and personally responsible for any violation of the law by the installation or use of this product. In no case will SuperATV® be held liable if Buyer violates the law or uses the product in an unsafe manner.

The Buyer is responsible to fully understand the capability and limitations of his/her vehicle according to manufacturer specifications, warnings and instructions and agrees to hold SuperATV® harmless from any damage resulting from failure to adhere to such specifications, warnings and/ or instructions. The Buyer is also responsible to obey all applicable federal, state, and local laws when operating his/her vehicle while using this product, and the Buyer agrees to hold SuperATV® harmless from any violation thereof.

Installation. The installation of this product on your vehicle indicates that you have had the opportunity to inquire about applicable local, state, and federal laws and ordinances and that you have read and understand, and accept all of the terms of, this Disclaimer.

SuperATV® shall not be responsible for the proper installation, use, and service of this product. Rather, the Buyer shall be solely responsible for the installation of the product and any damage that may be done to the vehicle or vehicle components as a result of modifications made by the Buyer.