

INSTALLATION INSTRUCTIONS
Game Loader Rack: for Honda Pioneer 700

- Do not discard packaging until product has been successfully installed.
- Installation performed with SuperATV Roof installed.
- Avoid hot and/or rotating components when routing any wiring.
- Secure wiring with provided wire-ties.

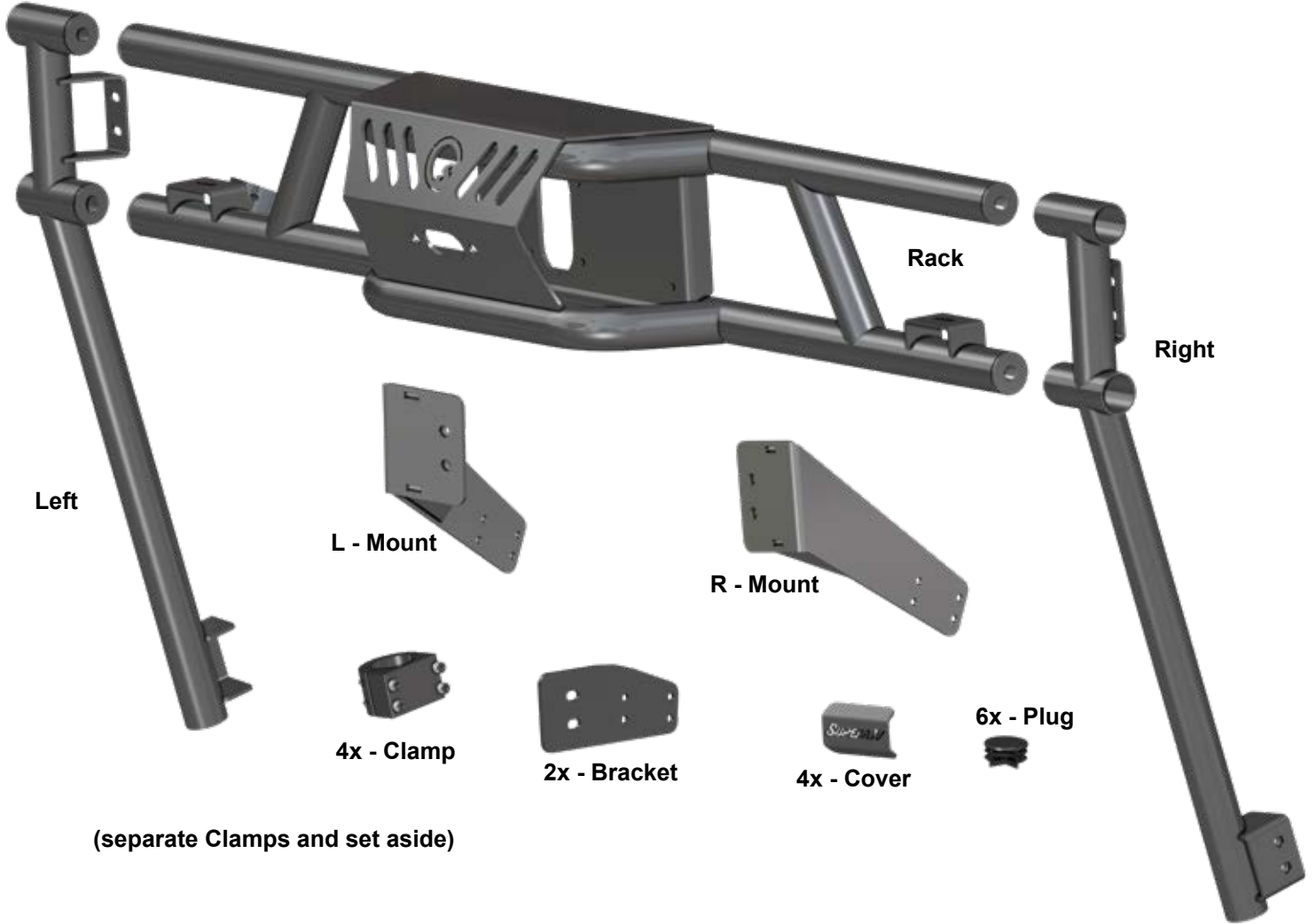

(kit contents continue on following page)

Need help with your installation?

 sales@superatv.com	 www.superatv.com
 1-855-743-3427	 8:00am - 8:00pm EST M-Th 8:00am - 7:00pm EST Friday 9:00am - 2:00pm EST Saturday

Read instructions and view illustrations before beginning.

*Thank You
 For Choosing*
SUPERATV.COM[®]

(kit contents continued)

(see pages 9 - 12 for wiring and wire routing)

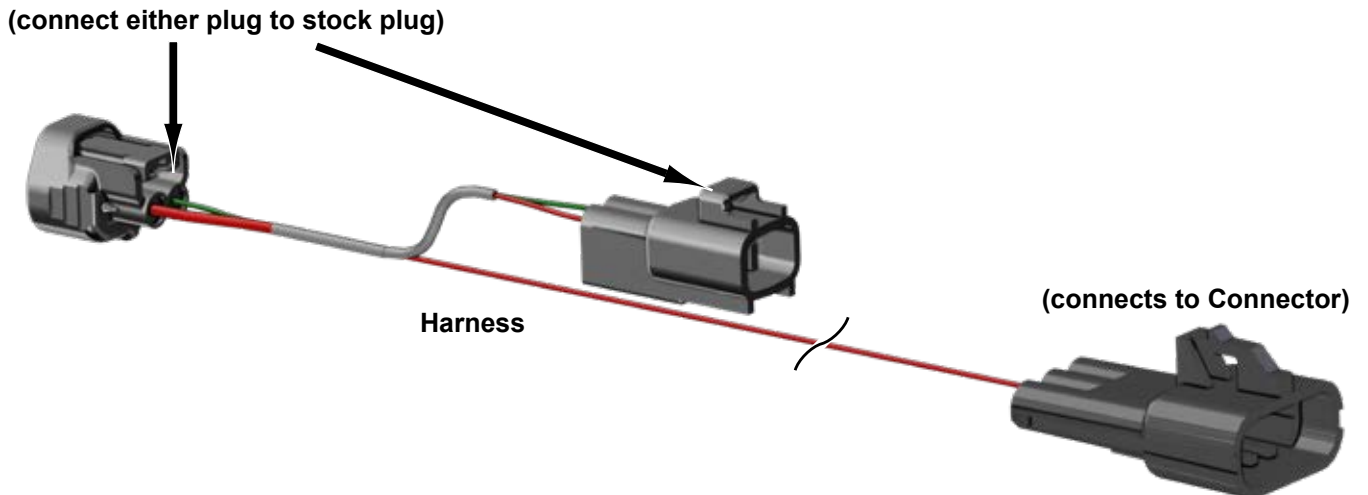
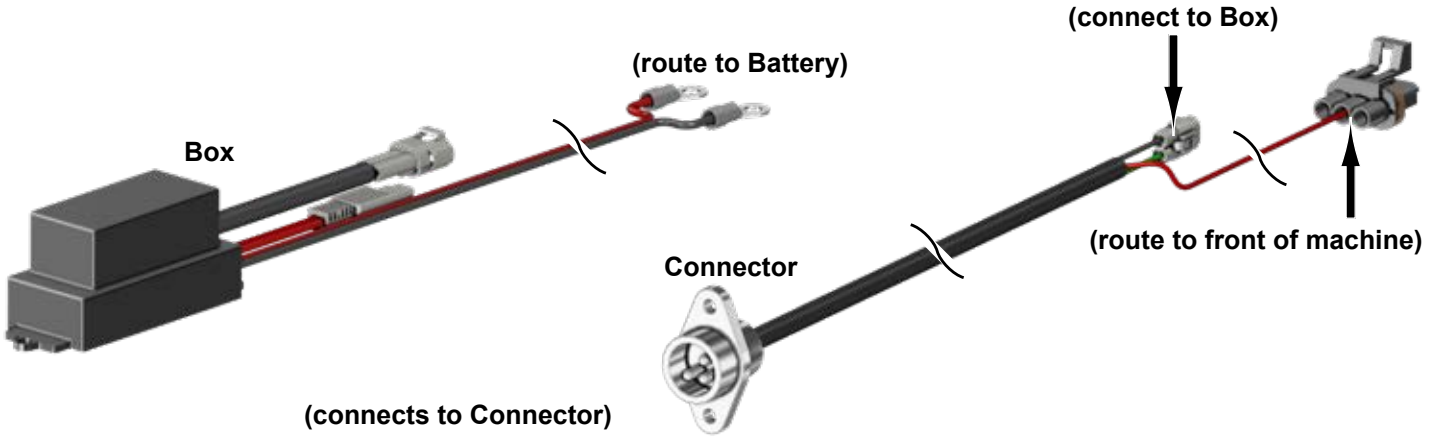



reinstall components after installation is complete

- Install Clamp and Bracket to Cage in location shown; hardware to be snug but not tight.
- Repeat for opposite side.

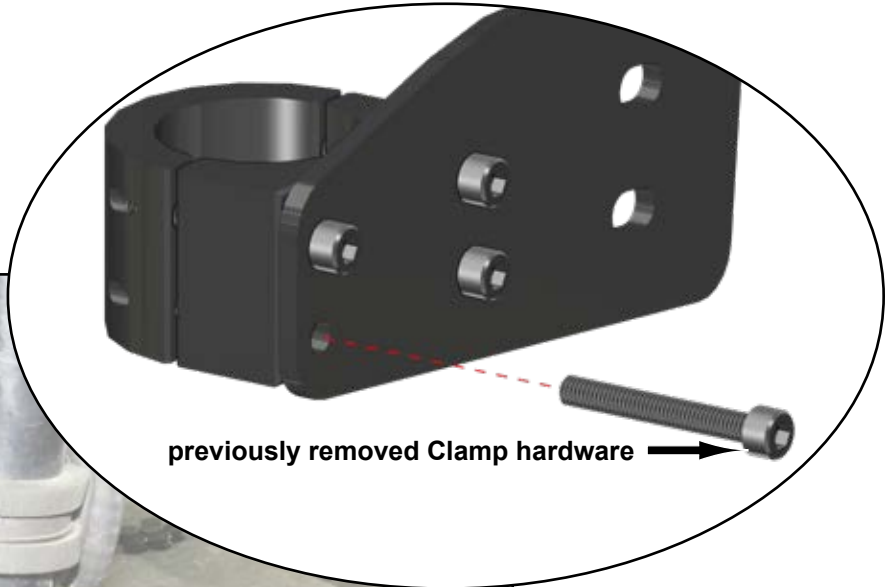

- Install Clamp and L - Mount to Cage in location shown; hardware to be snug but not tight.
- Repeat for opposite side.

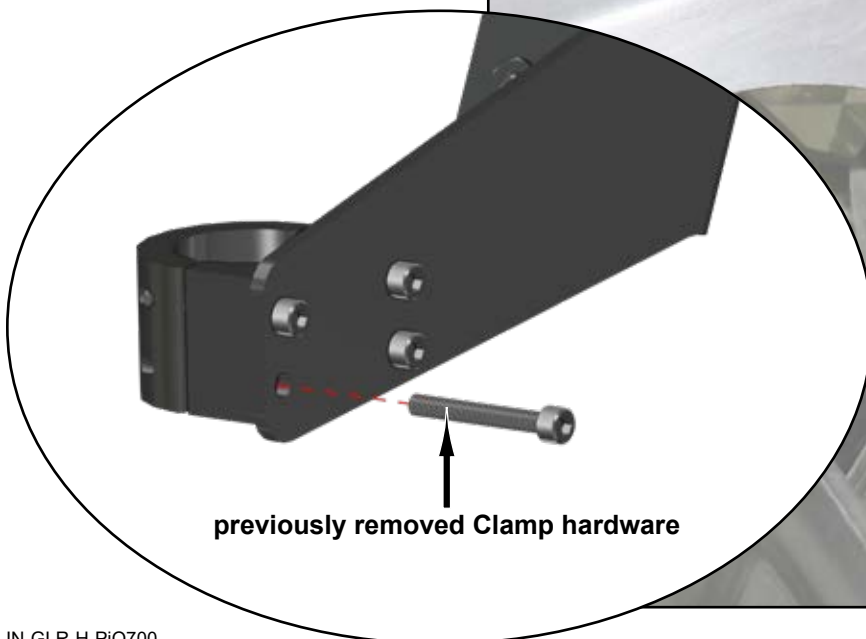
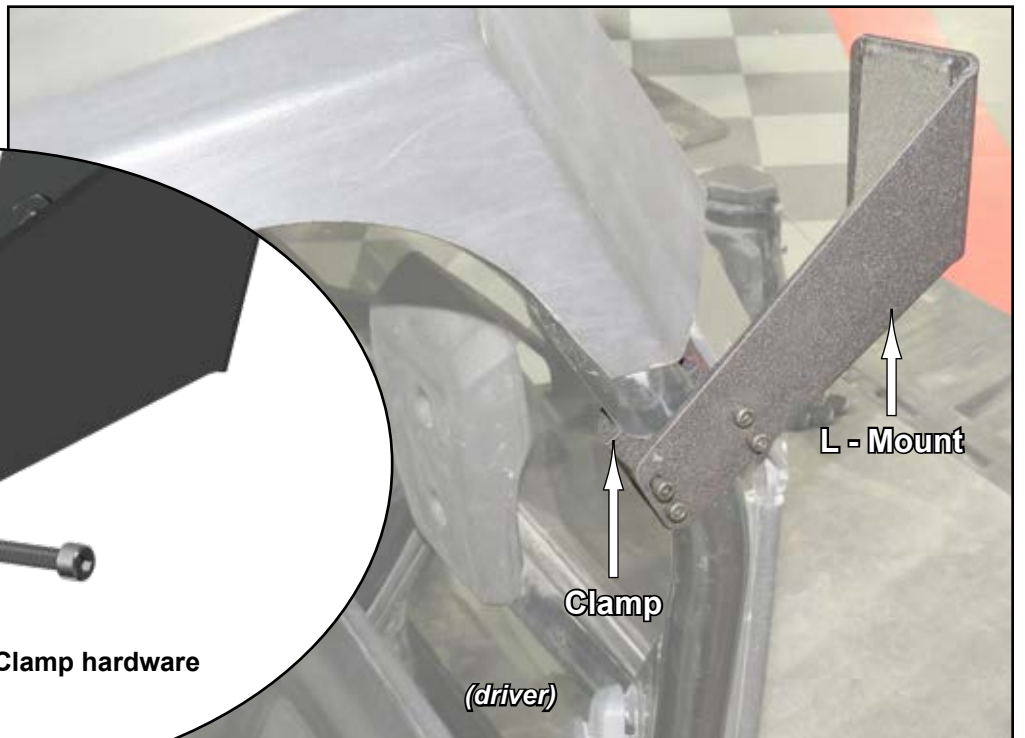

- Install Right and Left with hardware shown; do not tighten.
- Repeat for opposite side.

use provided Threadlocker



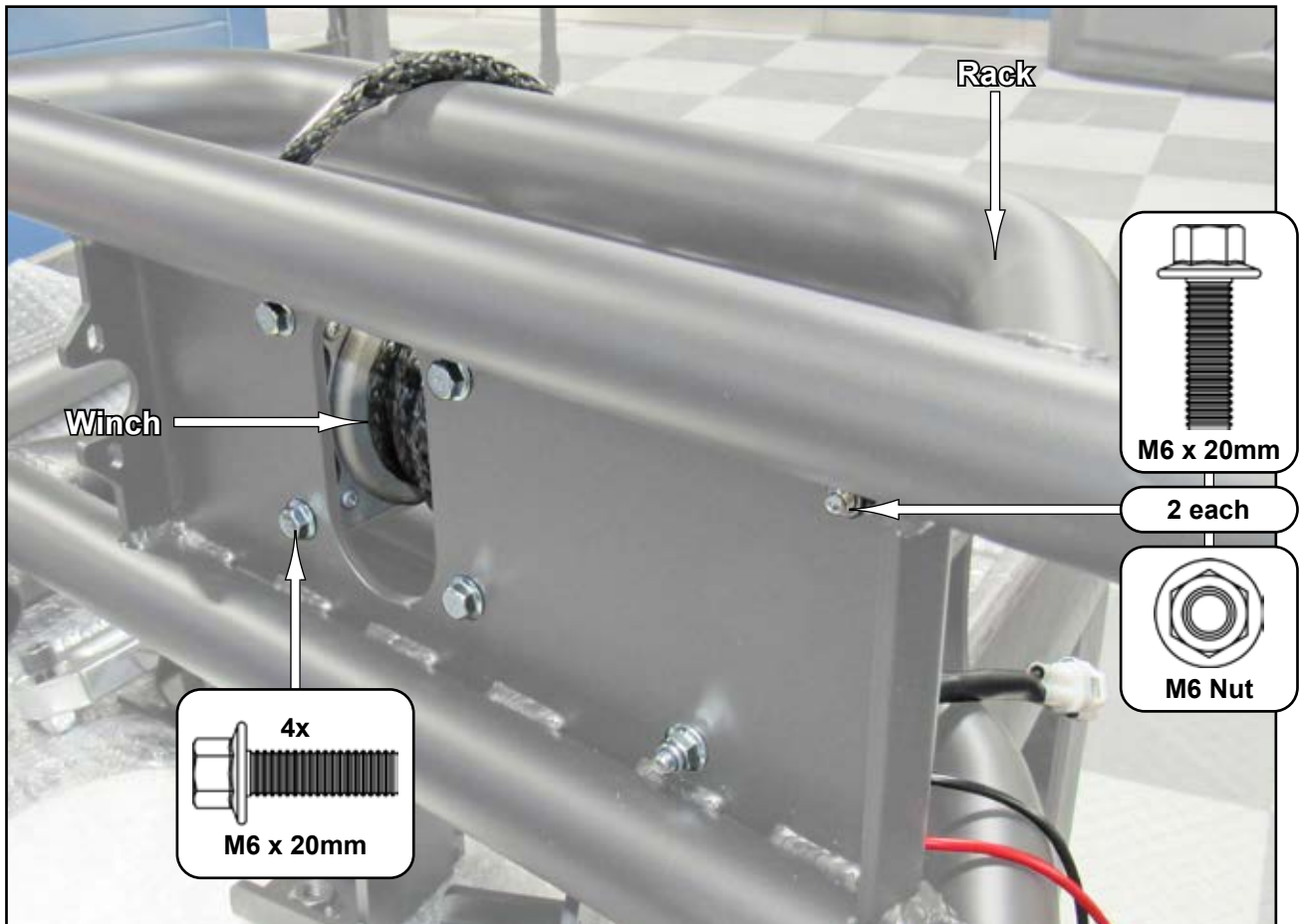

- Install Winch and Box to Rack with hardware shown; tighten.

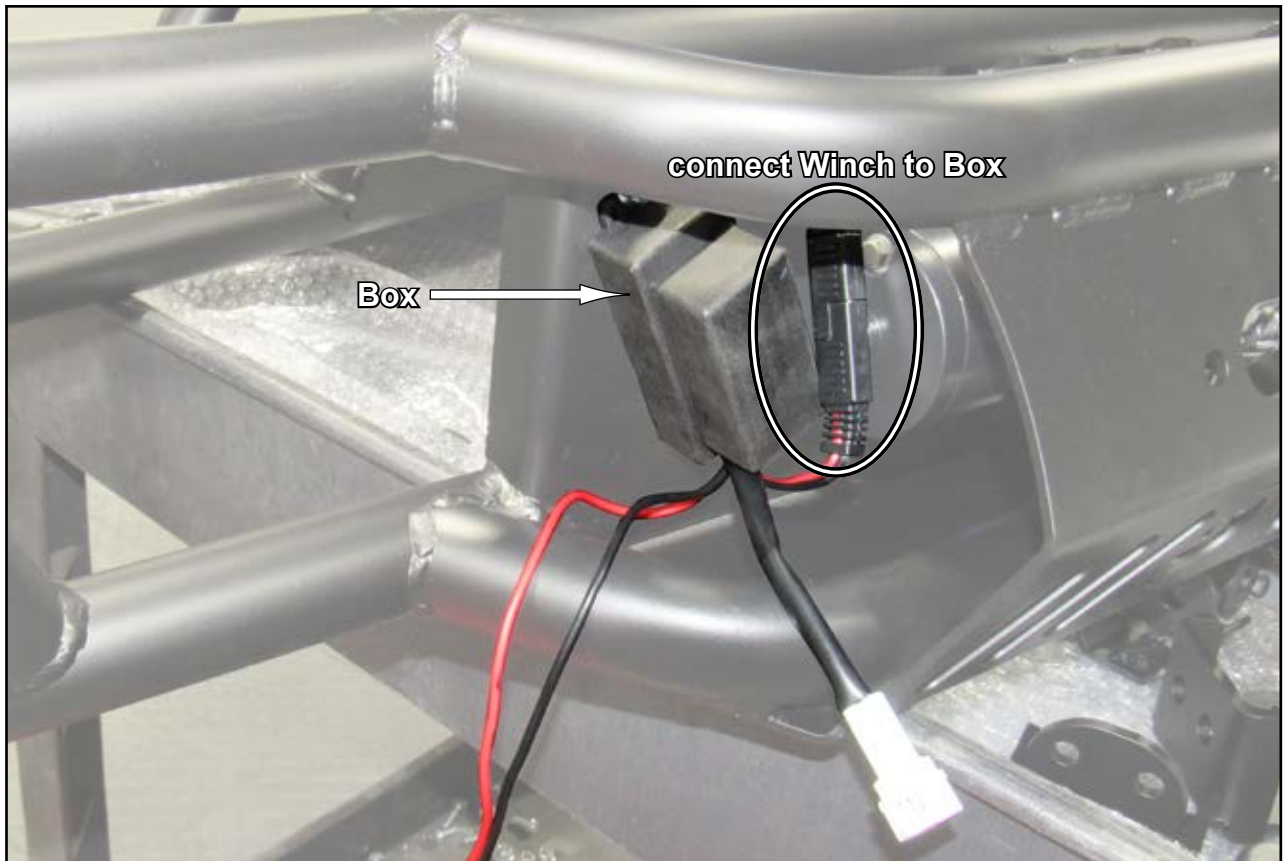

- Install Fairlead, Hook, and Hand Strap with hardware shown; tighten.

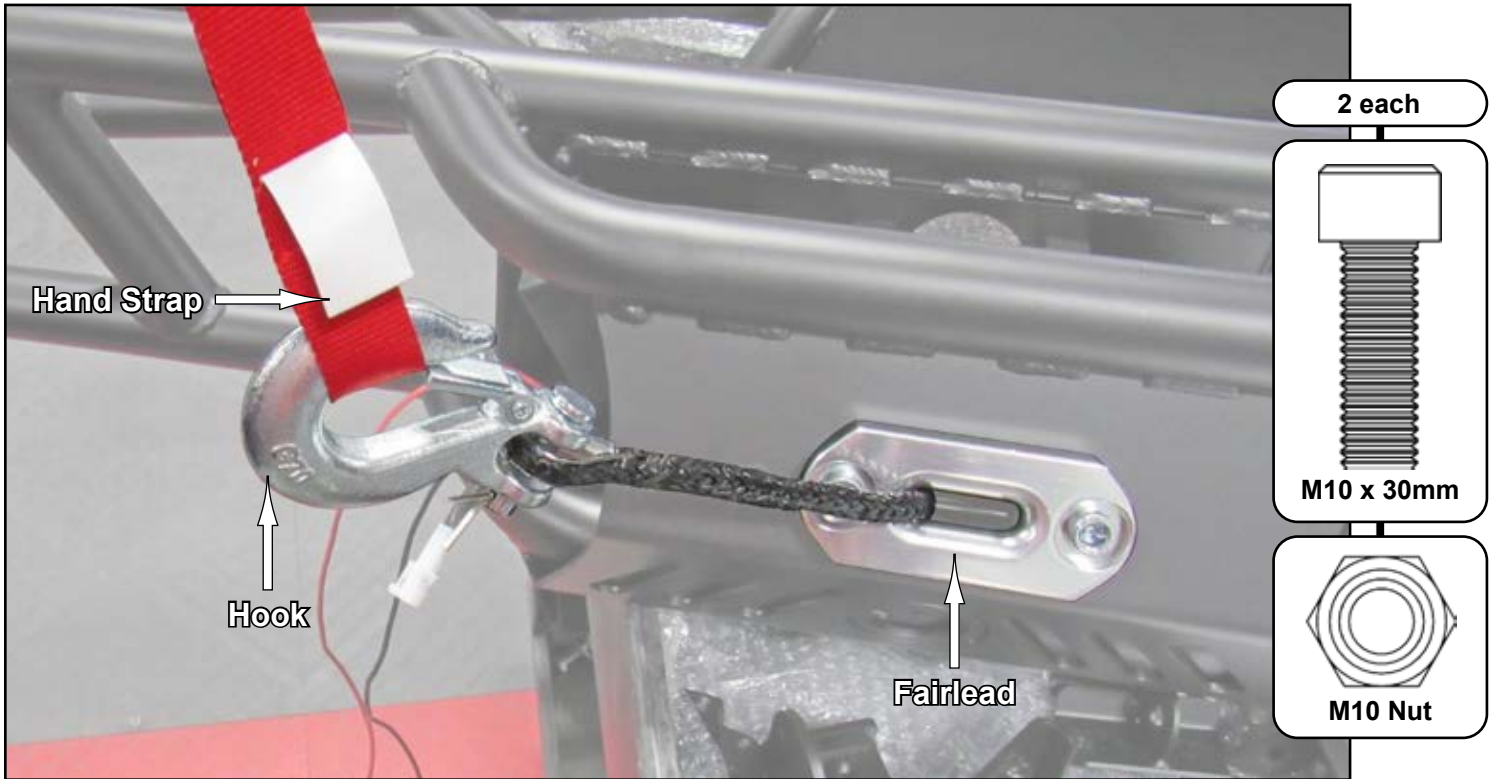

- Install Connector to Rack with hardware shown; tighten.

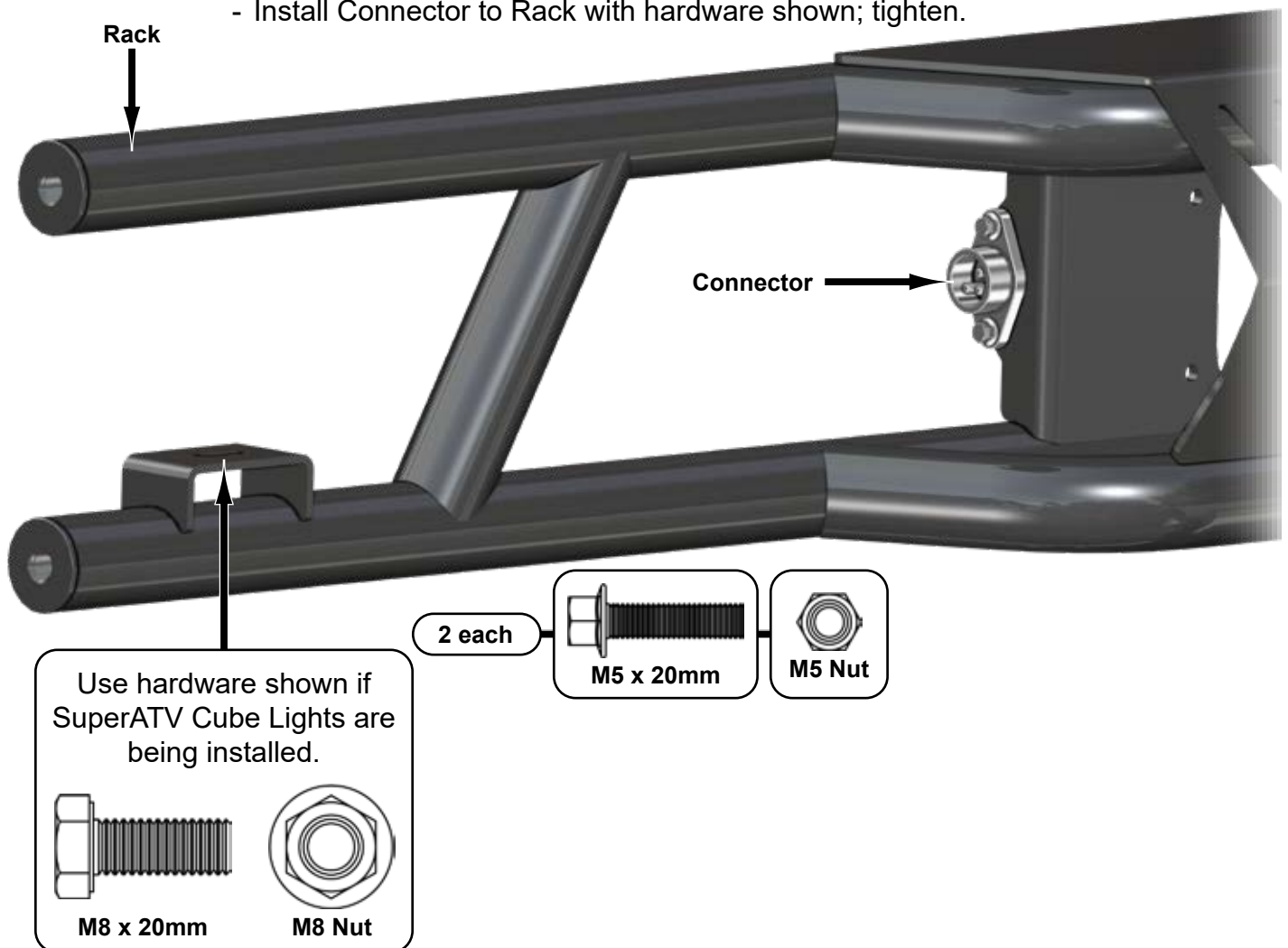

- Temporarily install Rack to Left and Right with hardware shown. Secure upper sections only; do not tighten.



- Secure lower section of Rack to Left and Right with hardware shown. Install Covers at this time. Do not tighten hardware.



- Remove hardware from upper section and install Cover and resecure Rack to Left and Right with hardware shown. Do not tighten hardware.

use provided Threadlocker

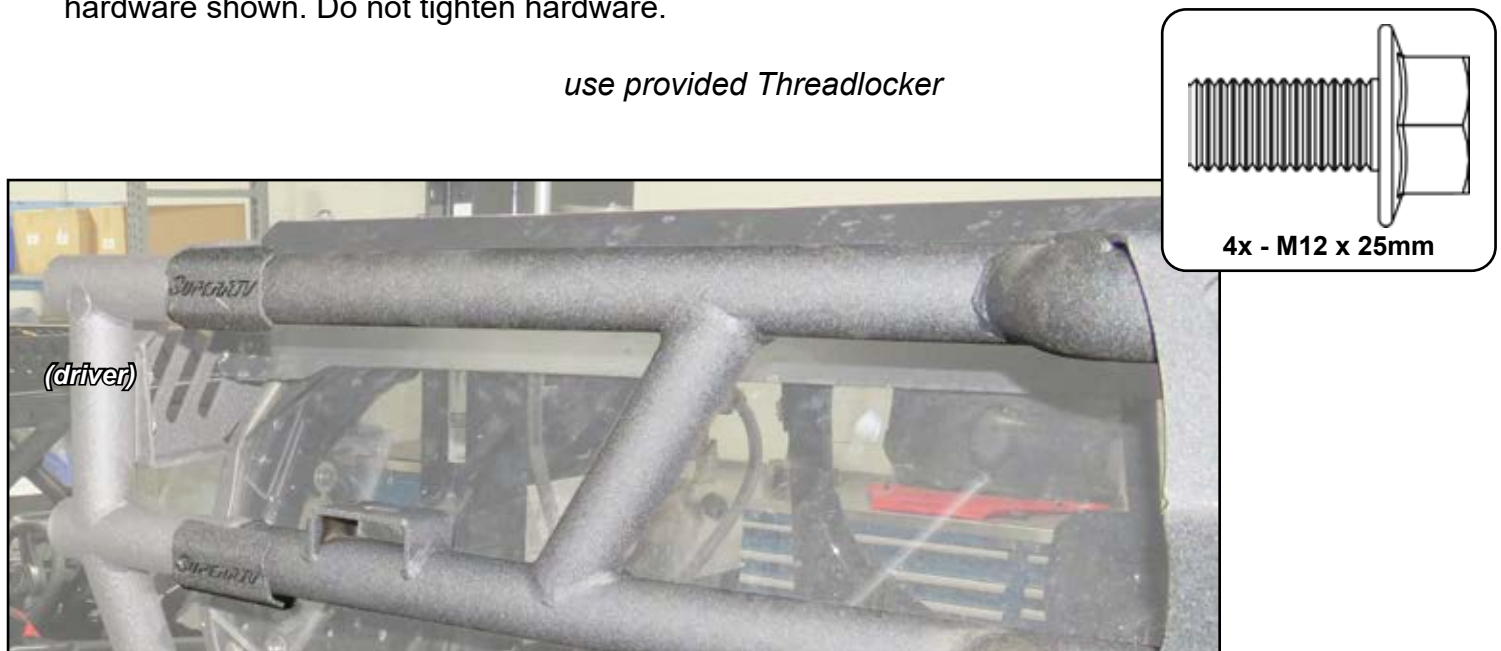

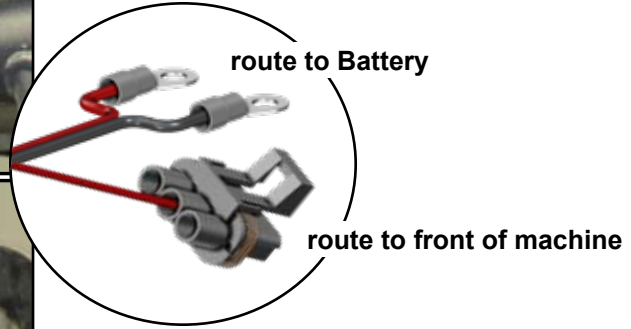

- Route wires from Box to Battery area of machine.

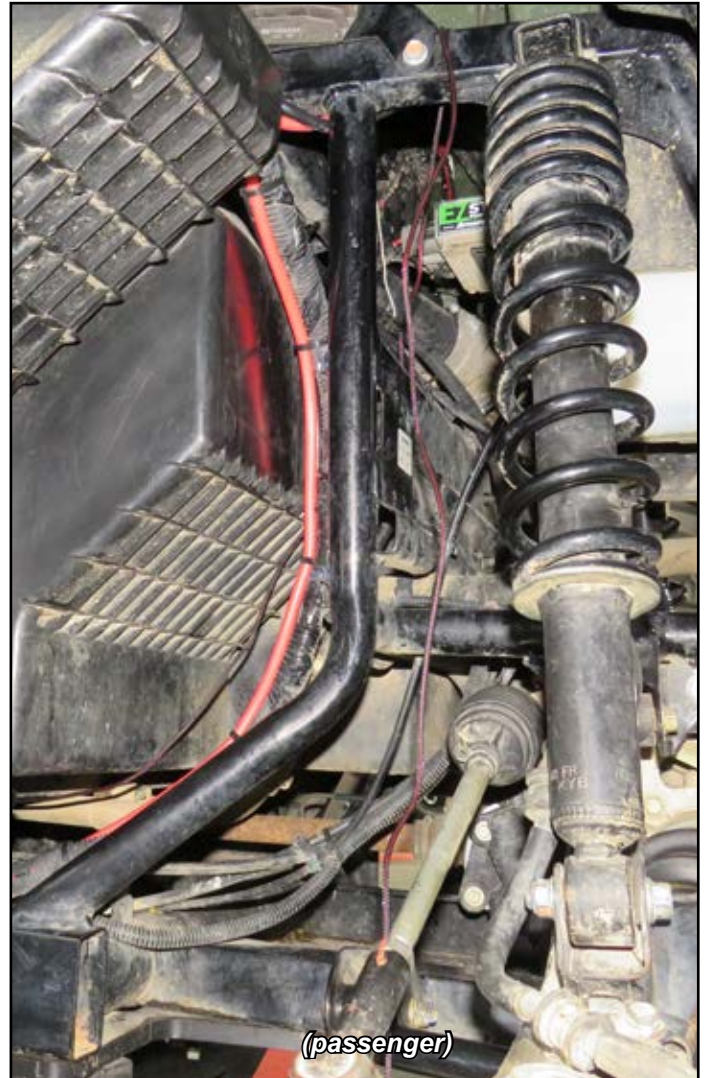

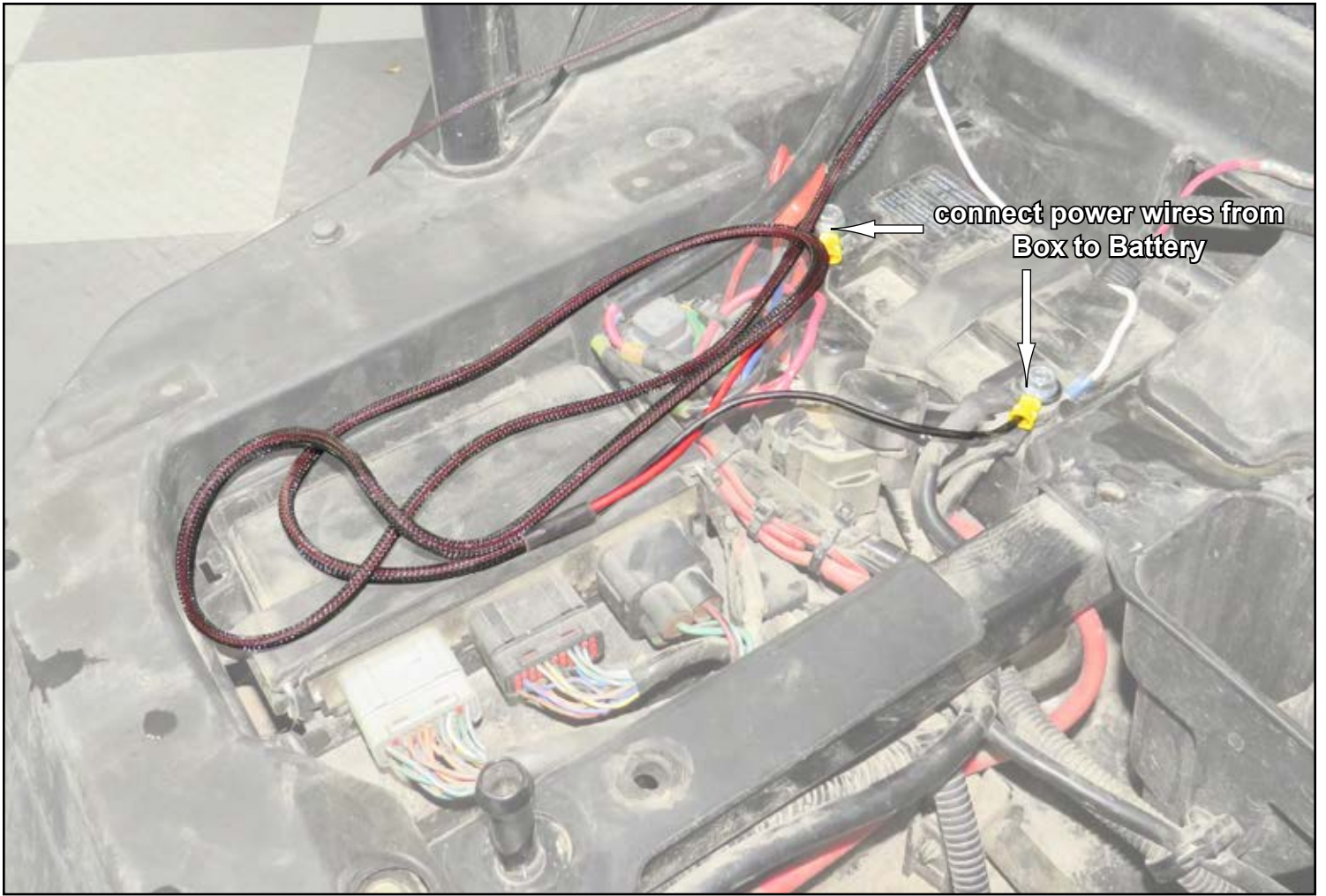

- Locate stock Plug behind Frame and on Firewall.

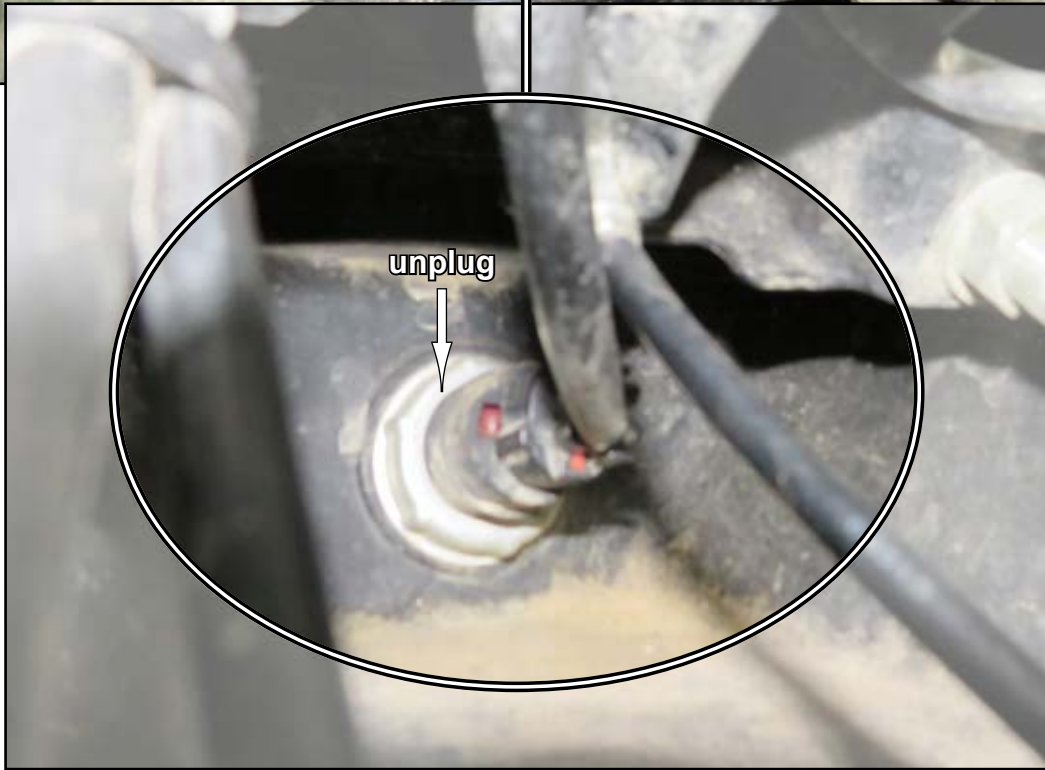
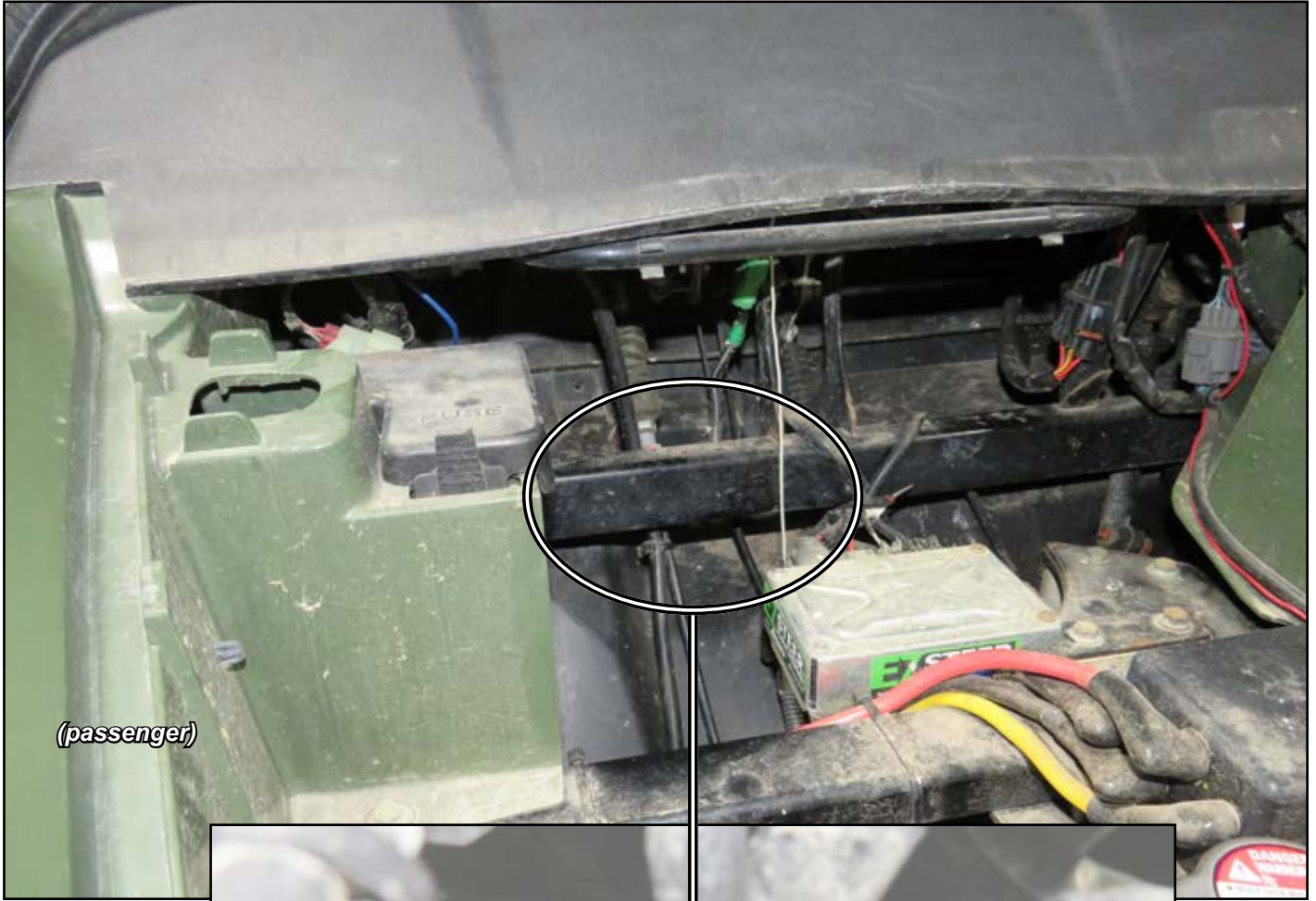

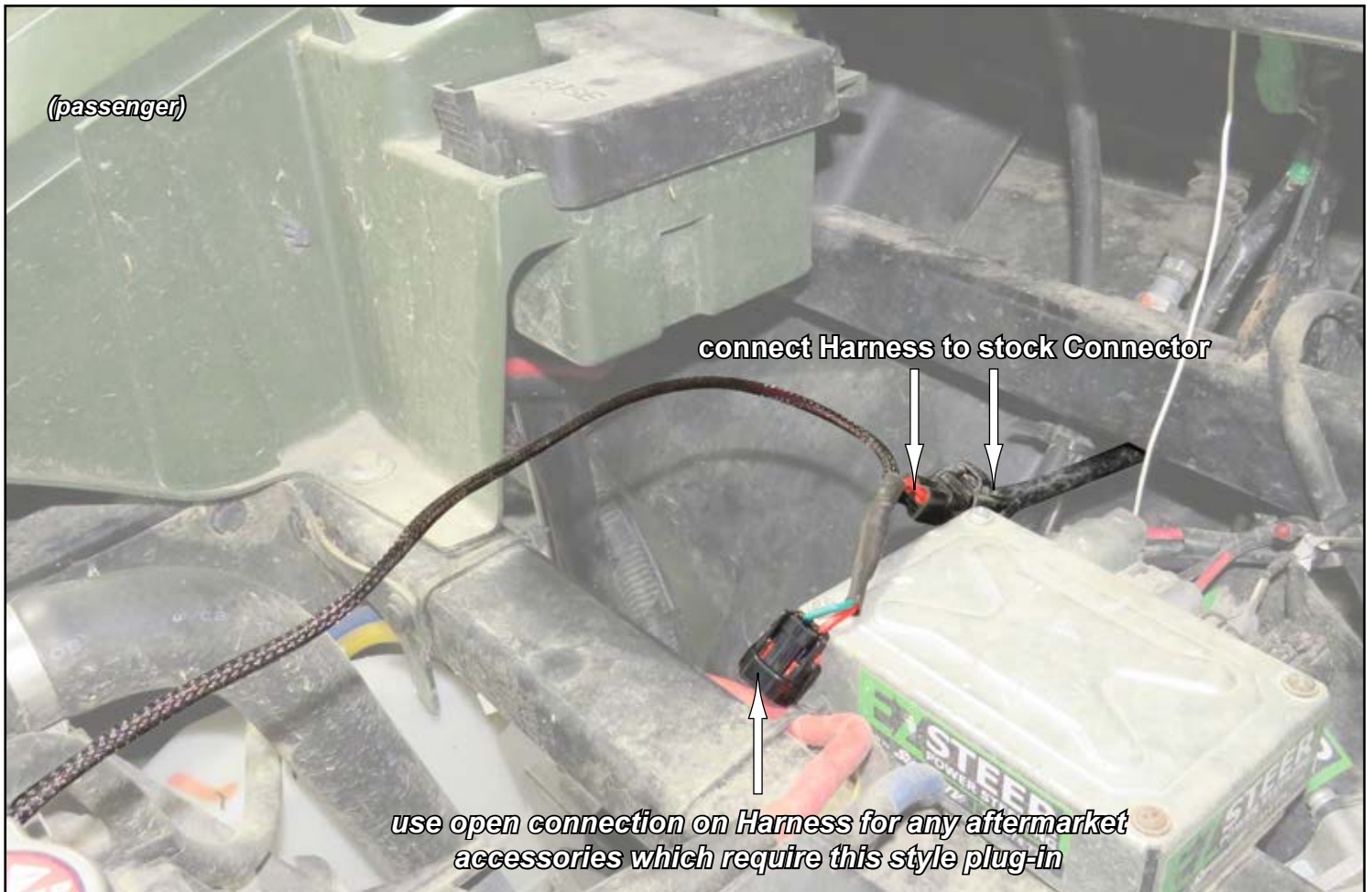

secure wires as needed

Install Plugs into Right and Left.



GETTING TO KNOW YOUR WINCH:

A winch is a powerful piece of machinery. For safe and confident operation, it is important to understand basic winch operations and specifications. See below for details on winch components and usage. Practice using winch before an actual situation occurs.

Winch has been engineered with several patented technologies.

Motor: Motor is powered by a 12 volt battery. Motor provides power to Mechanical Gear Mechanism which turns Winch Drum and winds Synthetic Rope.

Winch Drum: Cylinder on which Synthetic Rope is stored. Winch Drum feeds or winds Synthetic Rope depending on Winch switch direction.

Synthetic Rope: Designed specifically for Winches load capacity and is looped at end to accept clevis hook pin. Synthetic Rope feeds onto Winch Drum, through Fairlead, when in “under wind” position.

Fairlead: When operating Winch at an angle, Fairlead guides Synthetic Rope onto Winch Drum and minimizes damage/abrasion from winch mount or bumper.

Mechanical Gear System: Converts Motor power into extreme pulling forces.

Braking System: Braking action is automatically applied to Winch Drum when Motor is stopped and there is load on Synthetic Rope. A separate mechanical brake applies braking action.

Control System: Winch can be controlled by using Coded Remote.

Free Spooling Clutch: Allows user to manually disengage (“CLUTCH OUT”) Winch Drum from Mechanical Gear System; free spool. Engaging clutch (“CLUTCH IN”) locks Winch into Mechanical Gear System.

Pulley/Snatch Block (not included): Doubles pulling power of Winch or changes pulling direction without damaging Synthetic Rope. When pulling over 70% of rated line pull, it is recommended to use double line and snatch block.



SAFETY PRECAUTIONS:

Failure to heed these warnings and cautions may result in personal injury and/or property damage.

 **WARNING** - Do not exceed rated capacity.

 **WARNING** - Do not use Winch to lift vertically or as a hoist.

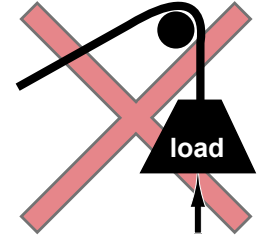

 **WARNING** - Never cut, weld, or modify any part of Winch or Synthetic Rope.

 **WARNING** - A minimum of (5) wraps of Synthetic Rope around Winch Drum is necessary for pulling and holding rated load.

 **WARNING** - Keep yourself and others a safe distance and to a side when Synthetic Rope is under tension.

 **WARNING** - Synthetic Rope may break before Motor stalls. For heavy loads at or near rated capacity, use a pulley block/snatch block to reduce load on Synthetic Rope.

 **WARNING** - When under load, never step over or go near Synthetic Rope.

 **WARNING** - Don't move vehicle to pull a load (towing) on Synthetic Rope. This can result in Synthetic Rope breakage.

 **WARNING** - Avoid "shock loads" by using control switch intermittently to take up slack in Synthetic Rope. "Shock loads" can exceed rated capacity for Synthetic Rope and Winch Drum.

 **WARNING** - Apply blocks to wheels of vehicle when on an incline.

SAFETY PRECAUTIONS (continued):

! WARNING - Never connect Synthetic Rope back onto itself.



! CAUTION - Use Hand Strap when handling Clevis Hook. Use gloves to protect hands when handling Synthetic Rope. Never let Synthetic Rope slide through bare hands.

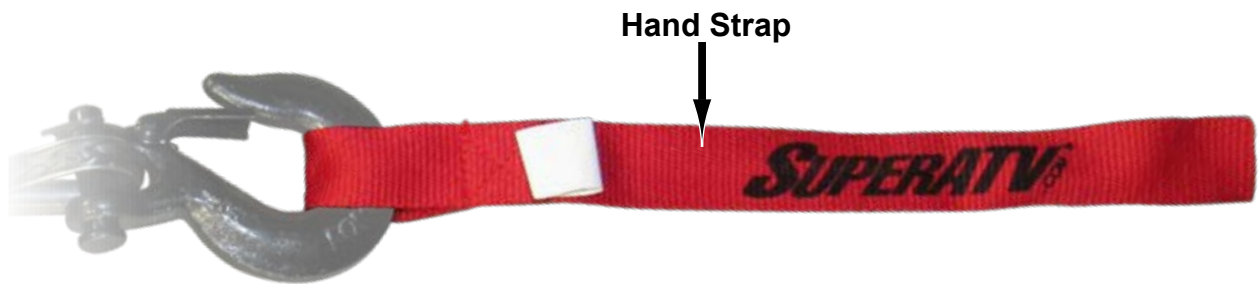

! WARNING - When re-spooling, ensure that Synthetic Rope spools in “under wind” position with Synthetic Rope entering Winch Drum from bottom, not top. To spool correctly, keep a slight load on Synthetic Rope while pushing Corded Remote button to draw in Synthetic Rope. Walk toward Winch while not allowing Synthetic Rope to slide through hands. Do not let hands get within 12” of Winch while re-spooling. Turn off Winch and repeat procedure until only a few feet of Synthetic Rope remain. Disconnect Remote Control and finish spooling by hand; rotate Winch Drum by hand with Clutch disengaged. Keep hands clear of Fairlead and Winch Drum while Winch is under power.

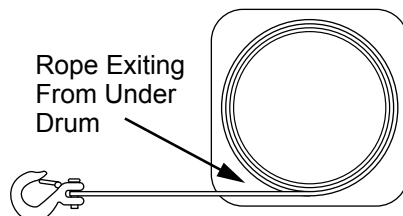

Side cutaway view of Winch

GENERAL TIPS FOR SAFE OPERATION:

- Winch is at rated capacity when spooling first Synthetic Rope layer onto Winch Drum. Overloading can damage components. For loads over 70% of rated line pull, it is recommend to use a pulley block/snatch block to double rope line. When doubling line, number of layers on Winch Drum is reduced and load on Synthetic Rope is reduced by as much as 50%. Attach to frame or other load bearing component when doubling line back to vehicle.

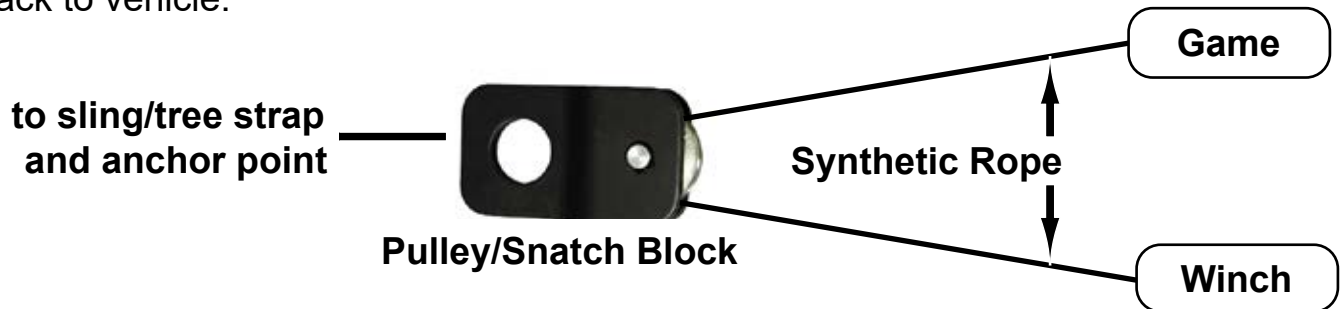

- To minimize battery drain and maximize power and speed of Winch, keep vehicle engine running during winching. Battery may be drained if Winch is used for a considerable amount of time with engine off.
- Know all features before actual use. Become familiar with rigging techniques, sounds made under various loads, way Synthetic Rope spools onto Winch Drum, etc. by performing several test runs.
- Inspect all components, hardware, and electrical connections before each use. If Synthetic Rope is frayed or damaged, replace immediately. Use only manufacturers replacement rope. Replace or remove any component that appears to be damaged, worn, or operating abnormally.
- Never connect Synthetic Rope back onto itself. Always use a snatch block, sling, or chain of suitable strength.
- Use only attachments and/or adapters supplied by manufacturer.
- Test run Winch in (2) directions before winching.

! **CAUTION** - If Motor stalls, stop winching immediately. Electric winches are designed for intermittent use. Do not use in constant duty applications. Keep duration of winching pulls as short as possible: Do not use for more than (1) minute when at or near rated load. If Motor becomes hot to touch, stop winching immediately. Allow Motor to cool before resuming.

! **CAUTION** - Never disengage Free Spooling Clutch when a load is on Winch.

Do not winch from an acute angle. Synthetic Rope will pile up on one side of Winch Drum causing damage to Synthetic Rope and Winch.

Short pulls from an angle can be used to straighten game. Long pulls must be done with Synthetic Rope at a 90° angle to winch/vehicle.

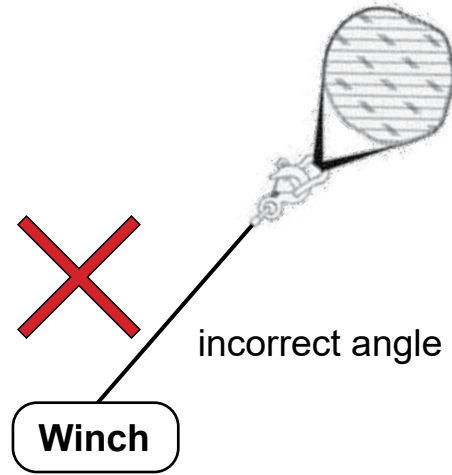
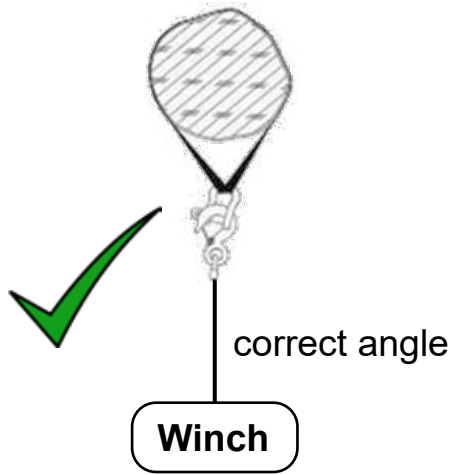

To absorb energy in event of Synthetic Rope failure, place a blanket or jacket over Synthetic Rope approximately 5ft - 6ft from Clevis Hook before pulling a heavy load.



OPERATING WINCH:

1. Take time to assess situation and thoroughly plan pull.
2. Set Free Spooling Clutch to “CLUTCH OUT” position.
3. Pull Synthetic Rope and attach to Game to be winched. Wear gloves and use Hand Strap.



CAUTION - Always leave minimum of (5) turns of Synthetic Rope on Winch Drum. Review “Safety Warnings” section of manual before continuing.

4. Secure Clevis Hook to anchor point: Sling, chain or snatch block. Do not attach Clevis Hook back onto Synthetic Rope.
5. Set Free Spooling Clutch to “IN” position.
6. Start vehicle engine so that battery is being charged while winching.
7. Slowly winch in Synthetic Rope just enough to take up slack.
8. Inspect Synthetic Rope. Make sure there are minimum 5 wraps of Synthetic Rope around Winch Drum.
9. To absorb energy in event of Synthetic Rope failure, place a blanket or jacket over Synthetic Rope approximately 5ft - 6ft from Clevis Hook.
10. Clear area. Make sure all spectators are away and that no one is directly in front, behind vehicle, or anchor point.
11. While standing aside and clear of tow path, use Corded Remote to control winching. If required, wait until Motor stops before reversing direction.
 - Be sure Synthetic Rope is winding evenly and tightly around Winch Drum.
 - Avoid shock loads; keep Synthetic Rope under tension. This can damage components and vehicles.
12. Winch is meant for intermittent use. Under full load with a single line rig do not power “in” for more than (1) minute without letting Motor cool down for a few minutes before resuming winching.
13. Once Game is loaded onto machine, winching operation is complete.
14. Set Free Spooling Clutch to “OUT” to release tension on Synthetic Rope. Winch is not meant to hold loads for long periods of time.
15. Disconnect Synthetic Rope from anchor.
16. Set Free Spooling Clutch to “IN” position and rewind Synthetic Rope. **Keep hands clear of Winch Drum and components.** Any material already on Winch Drum should be spooled tightly and neatly. Draw out and re-spool if necessary.
17. Secure Hook Strap and Clevis Hook.

SYNTHETIC ROPE MAINTENANCE:

- **Minimize abrasion:** Use movable Abrasion Sleeve whenever contact with rocks or other objects occurs. Slide Abrasion Sleeve up and down Synthetic Rope as required. Abrasion will reduce Synthetic Rope Life.
- **Keep clean:** Allowing dirt and debris to enter Synthetic Rope will lead to abrasion.
- **Avoid sharp bends:** A sharp bend will decrease Synthetic Ropes strength substantially under load and may cause damage or failure.



WARNING:

*If Synthetic Rope has become worn or is beginning to show signs of breaking, replace immediately. **Replace with identical part number.** Refer to SuperATV Synthetic Rope instruction when installing.*

MAINTENANCE:

- Check tightness of all mounting hardware and electrical connections periodically.
- Keep Winch clean. Remove all dirt and corrosion as required.
- Do not disassemble Mechanical Gear System. High temperature lithium grease has been applied at the factory. No user maintenance is required.

Liability Statement

SuperATV's® products are designed to best fit user's ATV/UTV under stock conditions. Adding, modifying, or fabricating any factory or aftermarket parts will void any warranty provided by SuperATV® and is not recommended. SuperATV's® products could interfere with other aftermarket accessories. If user has aftermarket products on machine, contact SuperATV® to verify that they will work together.

Although SuperATV® has thousands of satisfied customers, user should be aware that installing lift kits, long travel, or suspension kits, tires, etc. will change the ride of machine and may increase maintenance and part wear. Operating any off-road machine while, or after, consuming alcohol and/or drugs increases risk of bodily harm or death. No warranty or representation is made as to this product's ability to protect user from severe injury or death. SuperATV® urges operators and occupants to wear a helmet and appropriate riding gear at all times.

By purchasing and installing SuperATV® products, user agrees that should damages occur, SuperATV® will not be held responsible for loss of time, use, labor fees, replacement parts, or freight charges. SuperATV®, nor any 3rd party, will not be held responsible for any direct, indirect, incidental, special, or consequential damages that result from any product purchased from SuperATV®. The total liability of seller to user for all damages, losses, and causes of action, if any, shall not exceed the total purchase price paid for the product that gave rise to the claim.

SuperATV® will warranty only parts provided by SuperATV®. Any damage or problems with OEM housings, bearings, seals, or other manufacturers' products will not be covered by SuperATV®. SuperATV® parts and products are not warrantied if item was not installed properly, misused, or modified.

Installing, adding, modifying, or fabricating any factory or aftermarket product to your ATV/UTV may violate certain local, state, and federal laws. Be advised that laws vary depending on town, city, county, state, etc. Use of certain products on public streets, roads, or highways may be in violation law. The Buyer is solely and exclusively legally and personally responsible for any violation of the law by the installation or use of the product. You must abide by all local, state, and federal laws, including but not limited to vehicle safety, traffic laws, and ordinances. It is your responsibility to know the laws and how they apply to you.

The Buyer is responsible to fully understand the capability and limitations of his/her vehicle according to manufacturer specifications, warnings and instructions and agrees to hold SuperATV® harmless from any damage resulting from failure to adhere to such specifications, warnings and/ or instructions. The Buyer is also responsible to obey all applicable federal, state, and local laws and ordinances when operating his/her vehicle while using this product, and the Buyer agrees to hold SuperATV® harmless from any violation thereof.