



**DOWNLOAD COLOUR  
INSTALL MANUALS AT  
[www.bddiesel.com](http://www.bddiesel.com)**



## **Exhaust Manifold**



**Improved Design Manifolds for the Ford 3.5L EcoBoost**

2017-2020 Ford F150 3.5L, 2018-2020 Ford Expedition,  
2018-2020 Lincoln Navigator

<b>1043061</b>	<b>Exhaust Manifold Pair</b>
<b>1043062</b>	<b>Passenger Side Exhaust Manifold</b>
<b>1043063</b>	<b>Driver Side Exhaust Manifold</b>

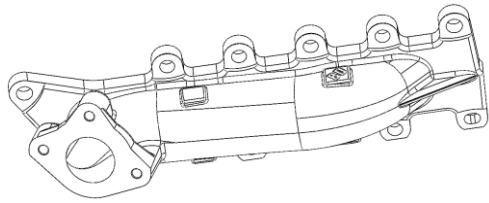
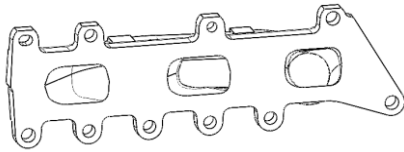

This kit will NOT fit 2011-2016 F-150 pickups or Transit vans. See BD part number 1043001.

## Kit Contents

1043061 (Manifold Pair)		
1403062	1403063	1403066 & 1403067
		
Manifold; Passenger Side 17-20 <b>Qty: 1</b>	Manifold; Driver Side 17-20 <b>Qty: 1</b>	Gaskets; Exhaust Manifold Pair <b>Qty: 1</b>

1403009	FT-11559037*	FT-11141221*	1462434
			
Spacer; Ford Manifold <b>Qty: 20</b>	Stud; M8x1.25x40 <b>Qty: 22</b>	Nut; M8x1.25 Lock Flange <b>Qty: 22</b>	Stud Install Tool; M8x1.25 <b>Qty: 1</b>

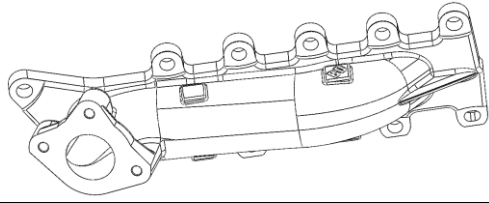
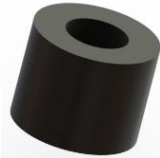
\*FT-11559037 and FT-11141221 come in a pre-bagged kit part number FK-1043001  
Two spare studs and nuts are included in this kit.

1043062 (Passenger Side Kit)		
1403062	1403009	1403067
		
Manifold; Passenger Side 17-20 <b>Qty: 1</b>	Spacer; Ford Manifold <b>Qty: 10</b>	Gaskets; Exhaust Manifold Passenger Side <b>Qty: 1</b>

FT-11559037	FT-11141221	1462434
		
Stud; M8x1.25x40 <b>Qty: 10</b>	Nut; M8x1.25 Lock Flange <b>Qty: 10</b>	Stud Install Tool; M8x1.25 <b>Qty: 1</b>

<b>1043063 (Driver Side Kit)</b>		
<b>1403063</b>	<b>1403009</b>	<b>1403066</b>
		
Manifold; Driver Side 17-20	Spacer; Ford Manifold	Gaskets; Exhaust Manifold Passenger Side
<b>Qty: 1</b>	<b>Qty: 10</b>	<b>Qty: 1</b>

<b>FT-11559037</b>	<b>FT-11141221</b>	<b>1462434</b>
		
Stud; M8x1.25x40	Nut; M8x1.25 Lock Flange	Stud Install Tool; M8x1.25
<b>Qty: 10</b>	<b>Qty: 10</b>	<b>Qty: 1</b>

***Suggested Additional Parts***

**Ford Turbo Gaskets:**

2017 Model Year: HL3Z-9450-A (QTY1, Passenger Side)

HL3Z-9448-C (QTY 1, Driver Side)

2018-2020 Model Years: JL3Z-9450-A (QTY 1 per turbo)

**Ford Turbo Bolts:**

W715673S900\* (QTY 3 per turbo)

W719737S900\* (QTY 3 per turbo)

\*VIN number will determine bolts required

***Introduction***

The BD performance exhaust manifold utilizes all 10 exhaust studs instead of only 8 the OEM manifold uses. This helps to prevent exhaust gasket failure. In addition, the new casting has an increased wall thickness to better handle heat and resist warping.

The manifold is port matched to the cylinder head to maintain flow efficiency.

New longer exhaust studs and spacers are included to further improve thermal durability and longevity.

## Driver's Side Removal & Install

Disconnect the vehicle battery and position the vehicle safely on a hoist before installation for safety.

Remove wheel and wheel well liner from driver's side.



Drain coolant from radiator, by opening the drain plug.

This is located on the bottom of the radiator, on the driver's side of the vehicle.



Disconnect turbo intake and charge piping from turbocharger.

**Note:** May be helpful to disconnect the opposite ends of the piping as well to make room.

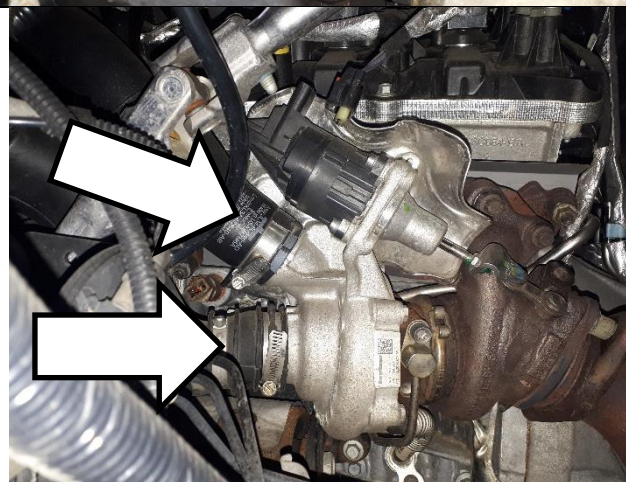

Disconnect down pipe from turbocharger by removing retaining nuts (x2).

**Note:** It may be helpful to remove both sides at this time.

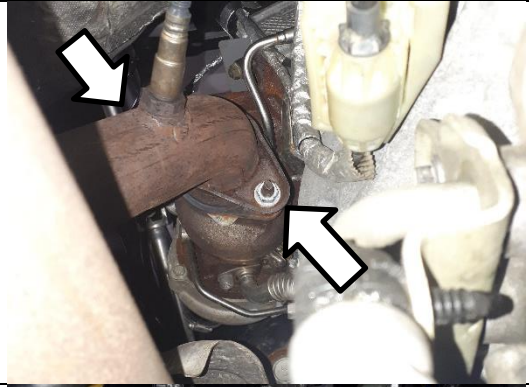

Remove oil supply tube, disconnecting from both turbocharger and engine block.

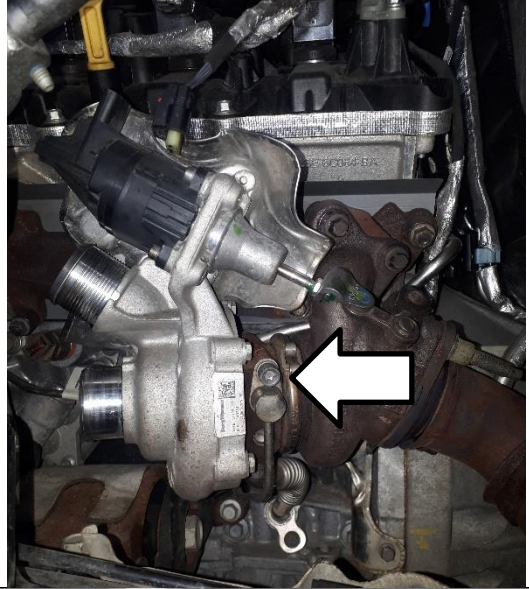

Disconnect Coolant piping from the side and rear of engine block.

**Note:** Additional coolant will spill out of these connections. A catch bucket will be helpful!

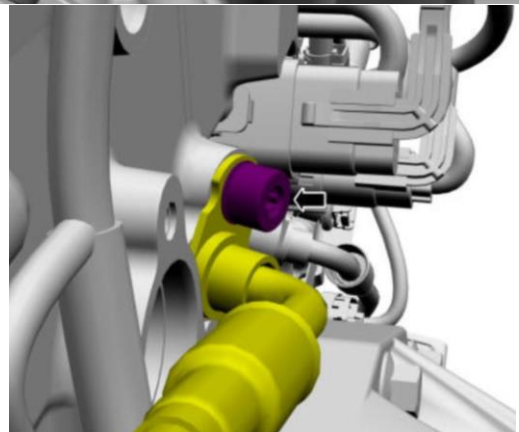
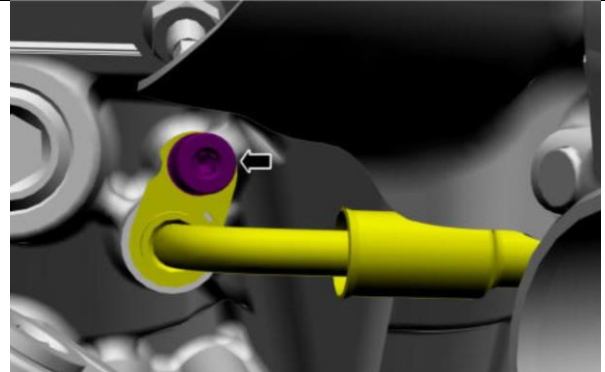

Disconnect oil drain tube from turbocharger and engine block.

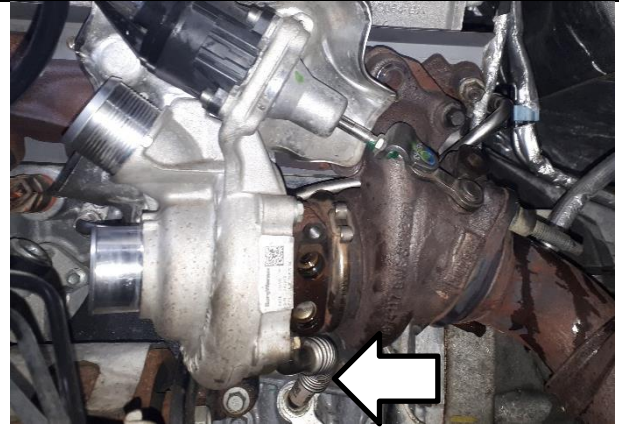

Disconnect the wastegate connector, and remove turbocharger from engine (Remove three (3) turbo bolts).

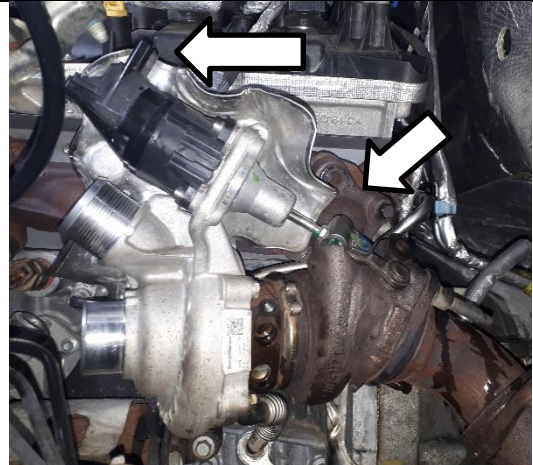

Remove and discard the exhaust manifold nuts and remove manifold.



Remove and discard the exhaust manifold gasket and the studs.



Clean the exhaust manifold mating surface of the cylinder head. Be careful not to gouge or scratch the surface.

Install the ten (10) new provided exhaust manifold studs and gasket.

Note additional stud locations (\*). Stud installation sequence is not important at this step.

Torque studs using supplied install tool.

**Stud install torque: 8.8 ft-lbs**

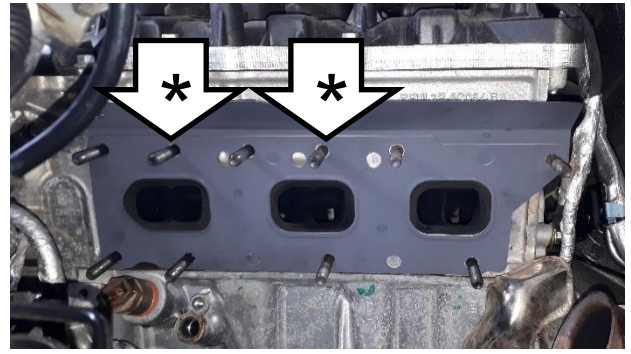

Install manifold, using supplied spacers and nuts.

Torque in two stages, following the sequence shown.

**Stage 1 Torque Spec: 14 ft-lbs**

**Stage 2 Torque Spec: 18 ft-lbs**

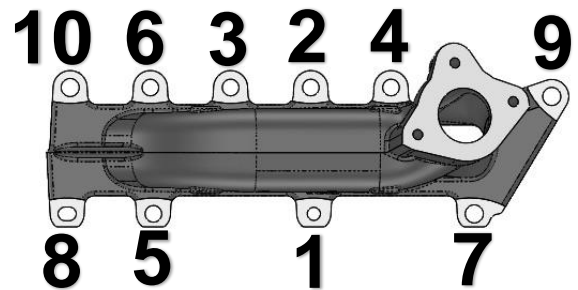
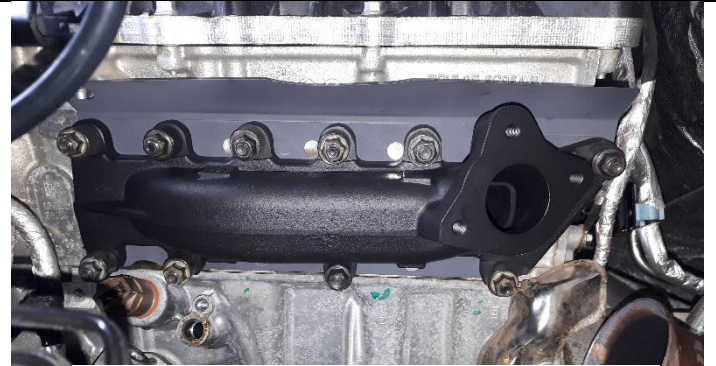

Install Turbocharger with oil drain pipe, using a new turbo gasket\*.

Torque turbo-to-manifold bolts in sequence shown.

**Stage 1 Torque Spec: 24 ft-lbs**

**Stage 2 Torque Spec: 24 ft-lbs**

**Note:** It's helpful to have the coolant fittings aligned into the engine block at this time.

\*Turbo Gasket not included. See Suggested Additional Parts above.

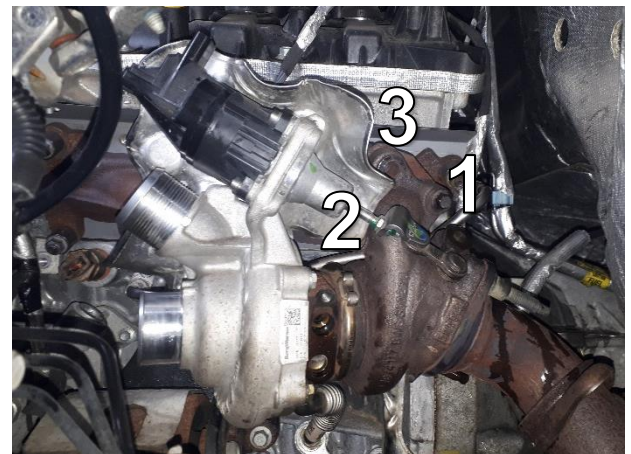

Reinstall oil supply tube to turbocharger and engine block.

Torque feed line and drain pipe fasteners now.

**Oil Feed Line Torque Spec: 7.5 ft-lbs**  
**Oil Drain pipe Torque Spec: 7.5 ft-lbs**

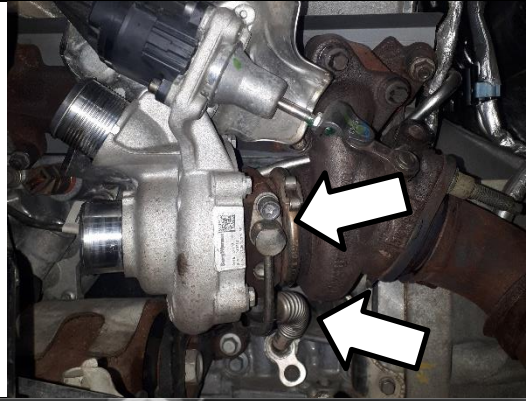

Torque coolant lines to specification at rear and side of engine block.

**Coolant fitting Torque Spec: 7.5 ft-lbs**

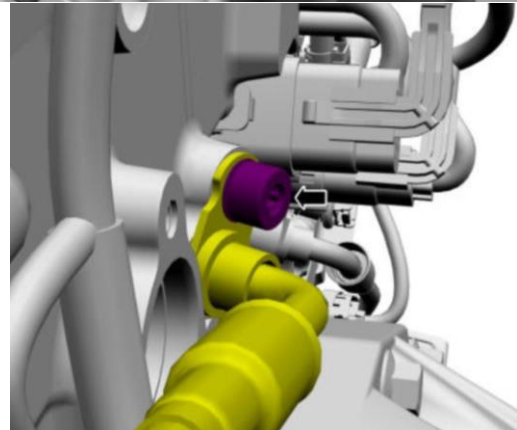
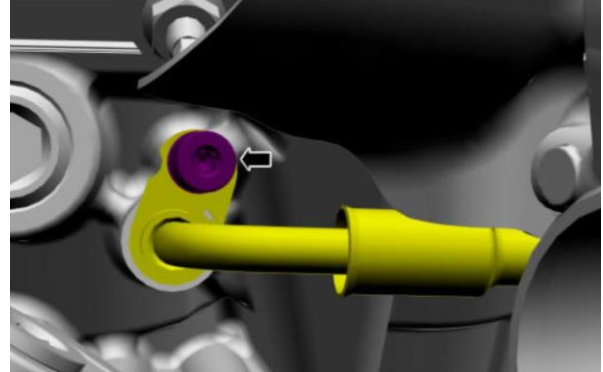

Reconnect intake and charge piping to turbocharger.

**Note:** Reconnect any other charge piping that was disassembled at this time.

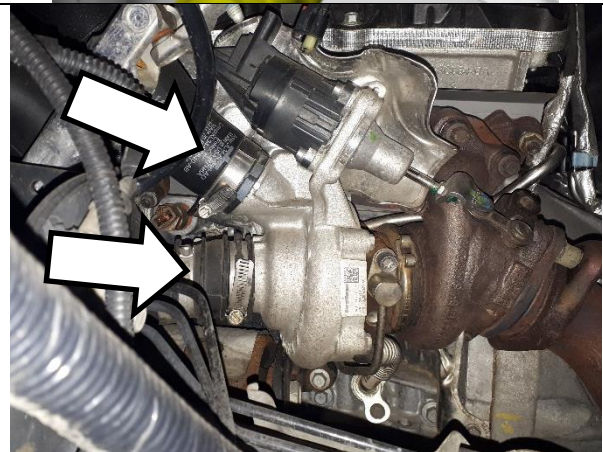



Reconnect downpipe to turbocharger.

**Note:** If continuing onto the passenger side, it will be helpful to leave the downpipe disconnected at this time.

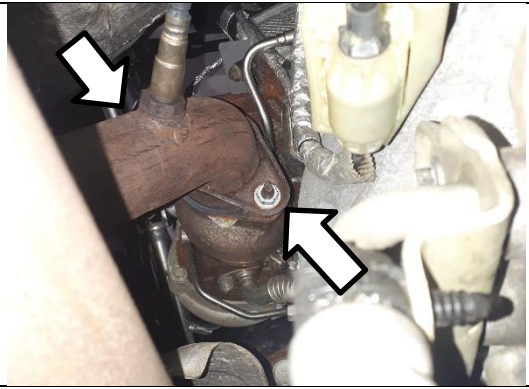

Driver's side is now complete, and ready for wheel well liner and wheel reinstall.

### ***Passenger Side Removal and Install***

Remove passenger side wheel and wheel well liner.



Disconnect Intake and charge piping from the turbochargers.

**Note:** May be helpful to disconnect the opposite ends of the piping as well to make room.

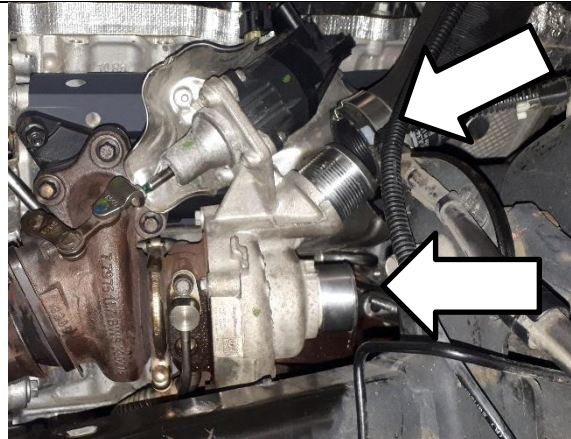

Disconnect the downpipe from the turbocharger.

**Note:** May be helpful to have the driver's side disconnected as well, to allow the exhaust to drop down.

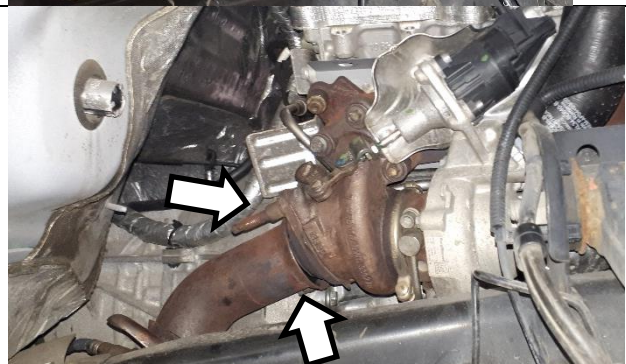

Remove belt, and unbolt the AC Compressor from the engine block and push aside.

**AC system does not need to be disconnected!**

**Note:** To remove the tension belt, use a prybar to roll the belt off the pulley, while turning engine with a wrench on the crank.

The Serpentine belt can remain in place during this procedure.

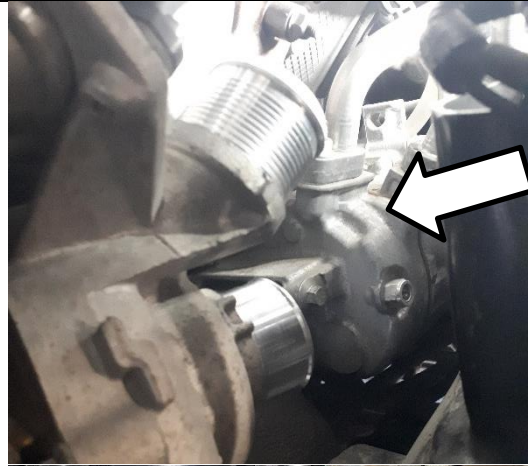

Disconnect both ends of the oil supply tube and remove.

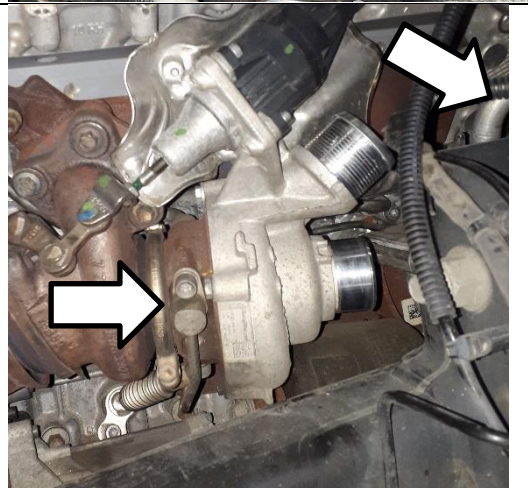

Disconnect Coolant piping from the side and rear of engine block.

**Note:** Additional coolant will spill out of these connections. A catch bucket will be helpful!

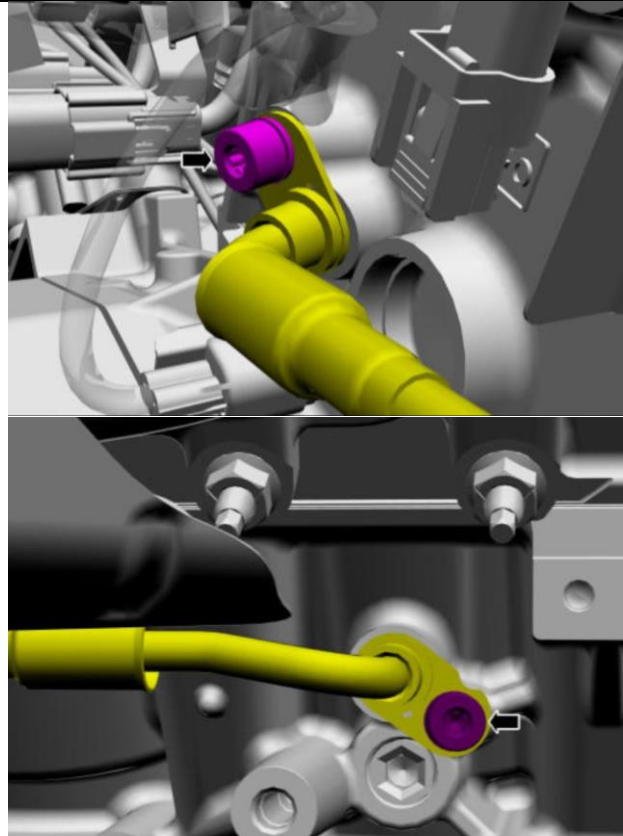

Disconnect oil drain tube from turbocharger and engine block.

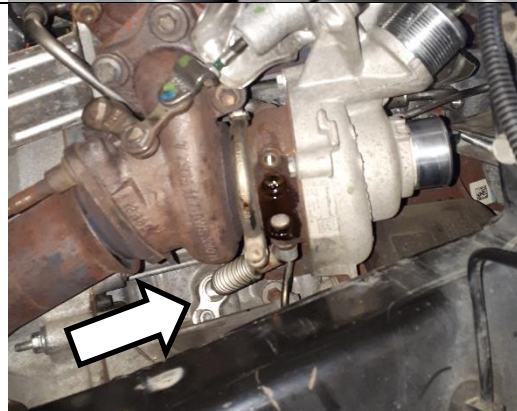

Disconnect the wastegate connector, and remove turbocharger from engine (Remove three (3) turbo bolts).



Remove and discard the exhaust manifold nuts and remove manifold.



Remove and discard the exhaust manifold gasket and the studs.



Clean the exhaust manifold mating surface of the cylinder head. Be careful not to gouge or scratch the surface.

Install the ten (10) new provided exhaust manifold studs and gasket. Note additional stud locations (\*). Stud installation sequence is not important at this step.

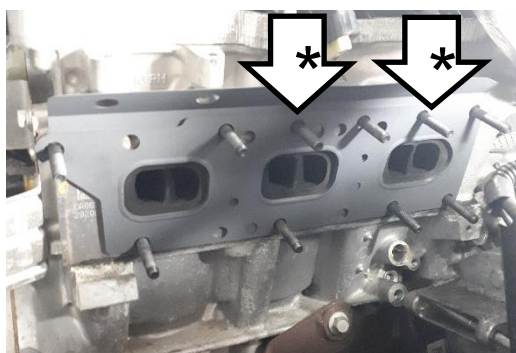

Use Supplied tool for stud install.

**Stud install torque:** 8.8 ft-lbs

Install manifold, using supplied spacers and nuts.



Torque in two stages, following the sequence shown.

**Stage 1 Torque Spec:** 14 ft-lbs

**Stage 2 Torque Spec:** 18 ft-lbs

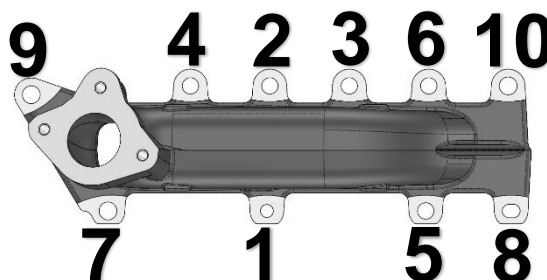

Install Turbocharger with oil drain pipe, using a new turbo gasket\*.

Torque turbo-to-manifold bolts in sequence shown.

**Stage 1 Torque Spec:** 24 ft-lbs

**Stage 2 Torque Spec:** 24 ft-lbs

**Note:** It's helpful to have the coolant fittings aligned into the engine block at this time.

\* Turbo Gasket not included. See Suggested Additional Parts above.

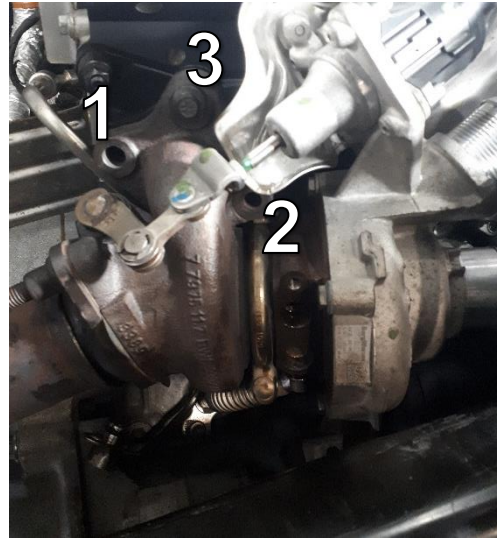

Reinstall oil supply tube to turbocharger and engine block.

Torque feed line and drain pipe fasteners now.

**Oil Supply Tube Torque:** 7.5 ft-lbs

**Oil Drain Tube Torque:** 7.5 ft-lbs

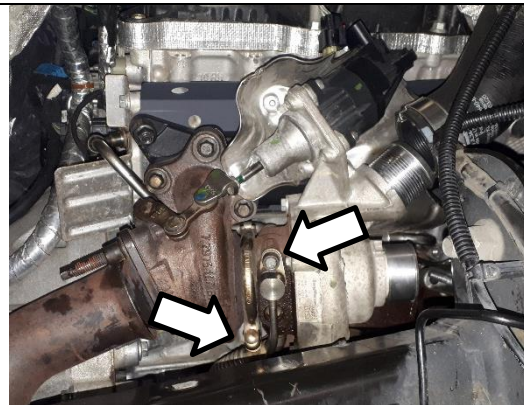

Torque coolant lines to specification at rear and side of engine block.

**Coolant fitting Torque:** 7.5 ft-lbs

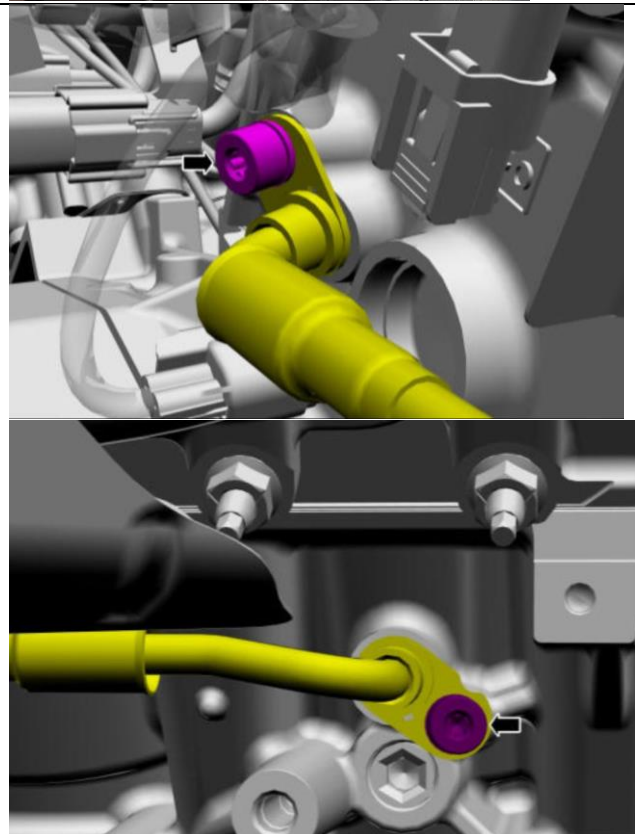

Reinstall AC Compressor back into position, and reinstall tension belt.

**Note:** For tension belt install, it's helpful to place belt onto AC compressor, then use a zip-tie to pull the belt onto the crank pulley, as it's rotated. Serpentine belt removed for image clarity, but can remain in place.

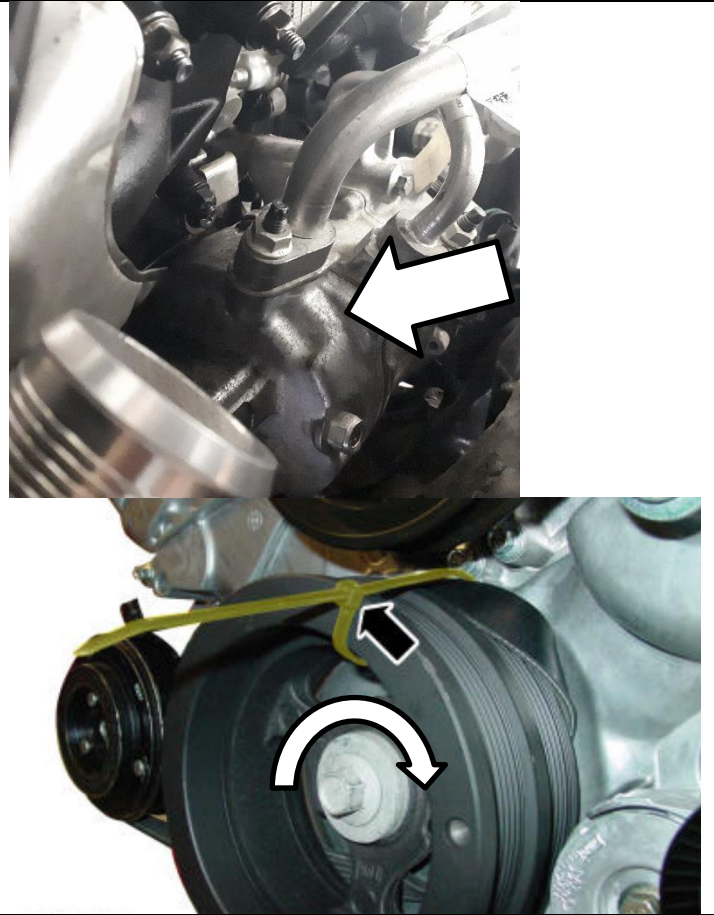

Reconnect intake, charge piping to turbocharger.

**Note:** Ensure all other intake piping is reconnected if disassembled earlier.

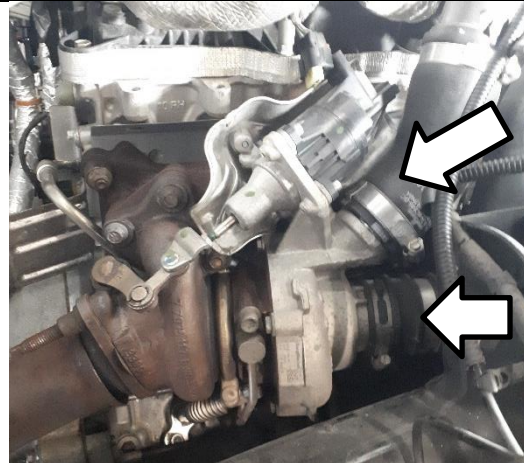

Reinstall exhaust downpipe to turbocharger.

**Note:** Ensure driver's side is also assembled at this time.

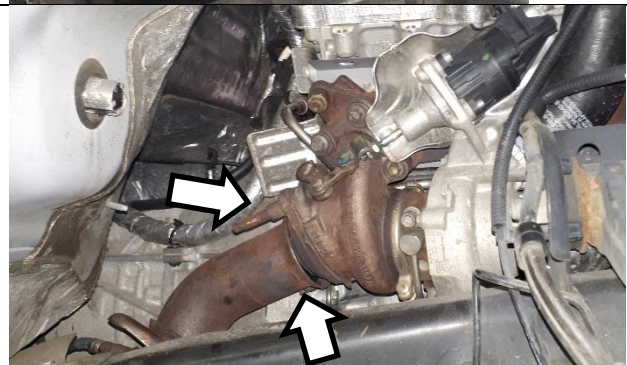

Passenger side manifold install is complete, and ready for wheel well liner and wheel reinstallation.

Reconnect the battery and fill the engine coolant.

**Coolant Spec:**

Vehicles built prior to Dec 2018:

Motorcraft Orange

Vehicles built after Jan 2019:

Motorcraft Yellow

**Coolant fill procedure:**

- 1) Fill coolant to max line in reservoir, and close cap.
- 2) Start engine and allow it to reach operating temp.
- 3) Shut off engine, and allow system to cool.
- 4) Top up coolant to max line if required
- 5) Repeat steps 1-4 as required.



While running engine during coolant fill process, inspect all connections (oil, coolant and exhaust) for leaks.

Installation is now complete!