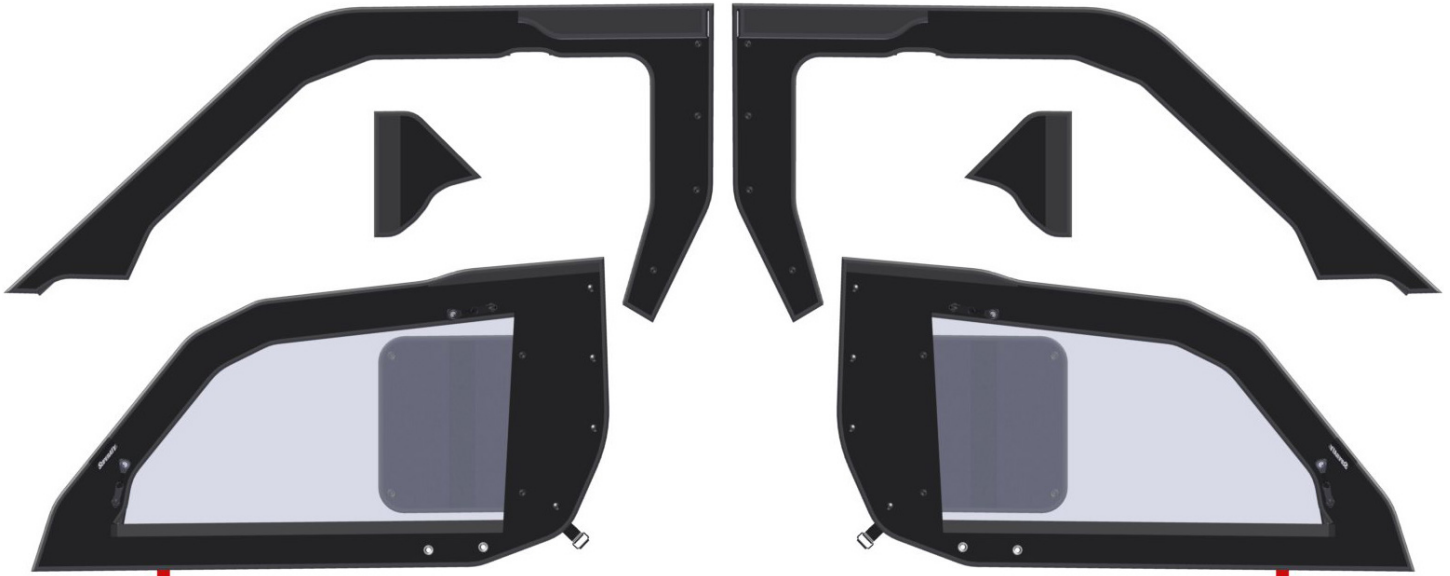


# INSTALLATION INSTRUCTIONS

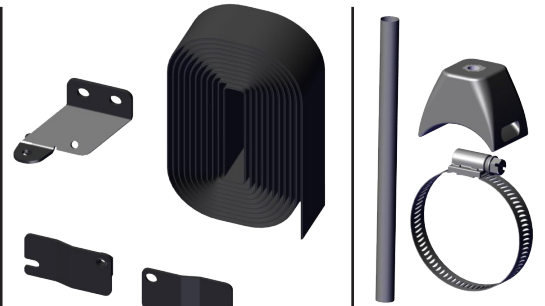
## Soft Enclosure: IN-SE-H-TAL



**Canvas Door Kit - Left & Right**



**Frame Kit**



**Mounting Kit**



**Clamp Kit**



Item	Description	Qty.
A	13 I.D. Spacer	8
B	M10x45 Hex Bolt	8
C	M10 Nylock Nut	8
D	M6x25 Hex Bolt	4
E	M8x55 Hex Bolt	2
F	M8x16 Button Hd.	6

Item	Description	Qty.
G	M6 Nylock Nut	2
H	M6x16 Button Hd.	2
J	Loop Clamp	2
K	M6x20 Hex Bolt	2
L	M8 Nylon Washer	4
M	Clevis Pin	2

Item	Description	Qty.
N	1/16" Hairpin Clip	2
O	M5x20 Hex Bolt	4
P	M5 Nylock Nut	4
Q	M8x16 Hex Bolt	2
R	M8 Split Washer	2
S	M8 Flat Washer	2

## What You'll Be Doing

- 🌀 First, removing door bolts & drill hole.
- 🌀 Applying Hook & Loop Tape to vehicle frame.
- 🌀 Removing Side Frame Bolts & installing brackets.
- 🌀 Installing Clamps to vehicle frame.
- 🌀 Installing Door Panel Framing.
- 🌀 Installing Fabric Shroud for Window.
- 🌀 Installing Outer window frame.
- 🌀 Installing small corner Panels.

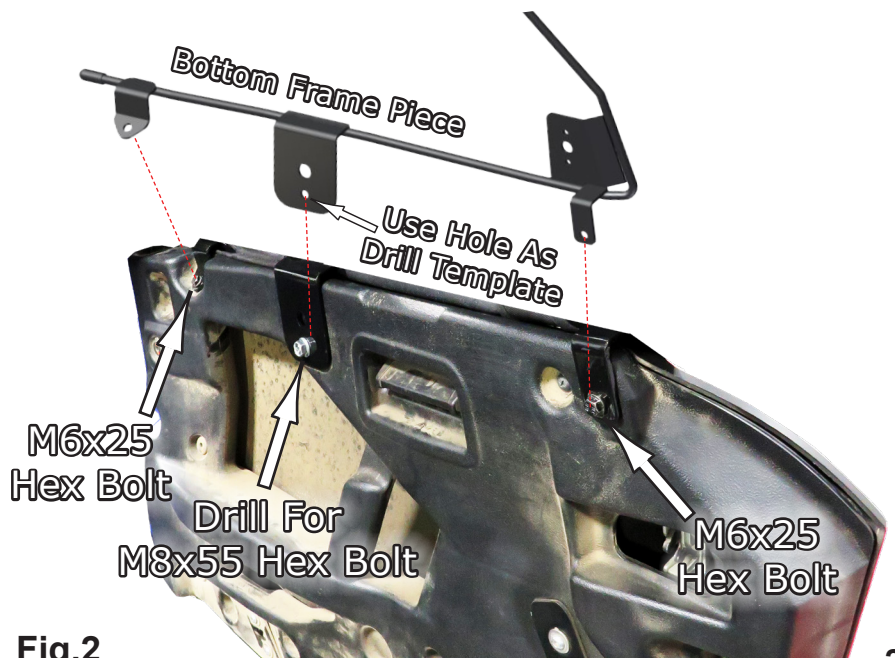
1. First you need to remove the three factory bolts on your existing door panel as shown in **Fig.1**. This will get you ready to install the framing in the next steps.



**Fig.1**

2. Next, you need to drill a hole in the door panel. First set the bottom frame piece on the door matching up the two end holes and installing the frame to the door using the factory bolts, if it is not already installed on your door. This will position the frame so you can use the hole in the center frame bracket to drill your hole in the panel with. The hole will need to be large enough for the M8x55 Hex Bolt, **item "E"** in your kit to go through. See **Fig.1-2**.

After you drill the hole, remove the frame piece. We will install it later in the following steps.



**Fig.2**

- Next, install the Adhesive Hook and Loop Tape to the frame bars where the door enclosure panel will attach to as shown in **Fig.3-4**.



**Fig.3**



**Fig.4**

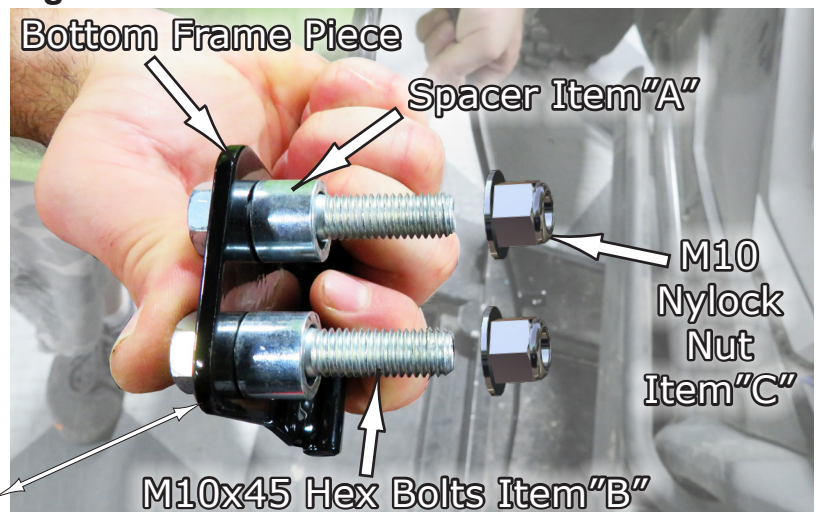
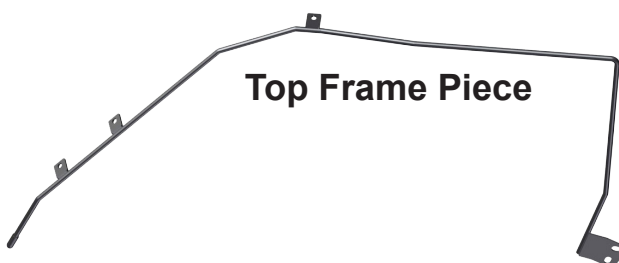
- After the Hook and Loop tape has been applied, you are ready to install the bottom frame piece you used to drill the hole with. First find the two large factory frame bolts and remove them. We will be using hardware from your kit to install the frame. See **Fig.5**.



**Fig.5**

- Now locate the Top Frame Piece. You will be installing it in the same hole you just removed the bolts from using the M10x45 Hex Bolts **Item "B"**, the Spacers **Item "A"** and the M10 Nylock Nuts **Item "C"** provided in your kit. See **Fig.6**.

You will install this end of the frame to the same location you just took the two large factory bolts out of, using the spacers and Nylock Nuts. Top Piece shown below.



**Fig.6**

6. **Fig.7** shows mounting the Top Piece to the frame. You may need to adjust the hole spacing a little to fit the bolts through in some cases. Install Bolts, Spacers and Nylock Nuts, but do not tighten until all of frame is in place and all bolts have been threaded in.



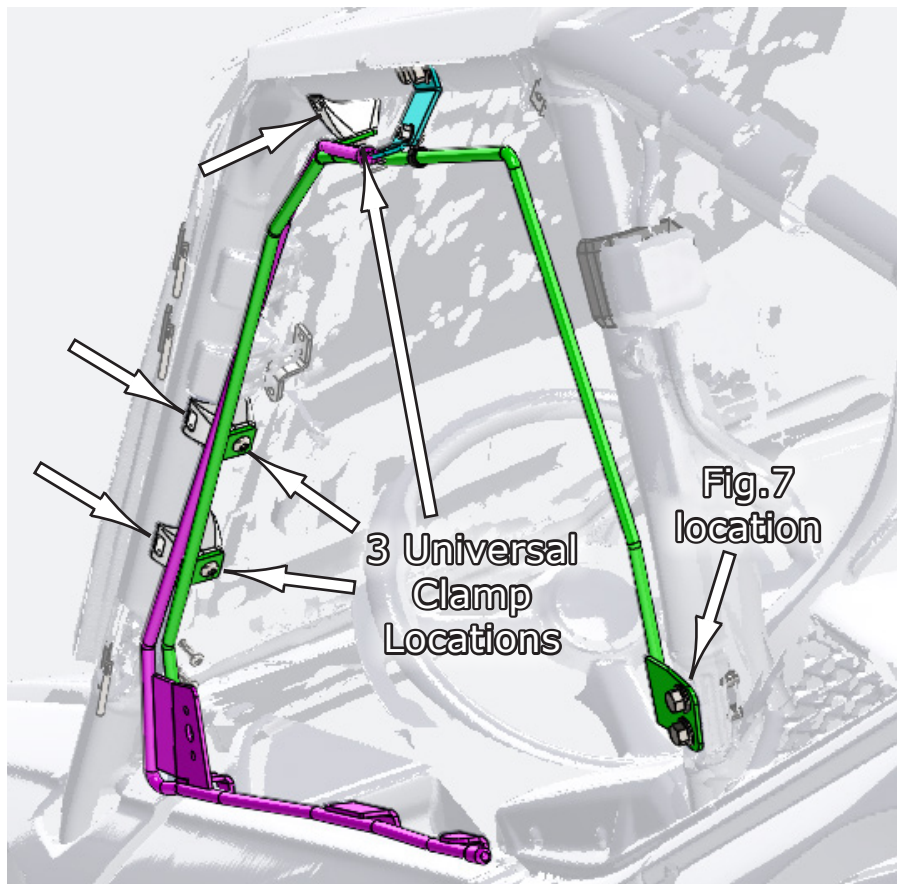
**Fig.7**

**PRE-ASSEMBLE UNIVERSAL CLAMPS BEFORE INSTALLING:**

Pre-assemble the Universal Clamps by sliding the heat shrink tubing onto the clamp band before inserting into clamp block.



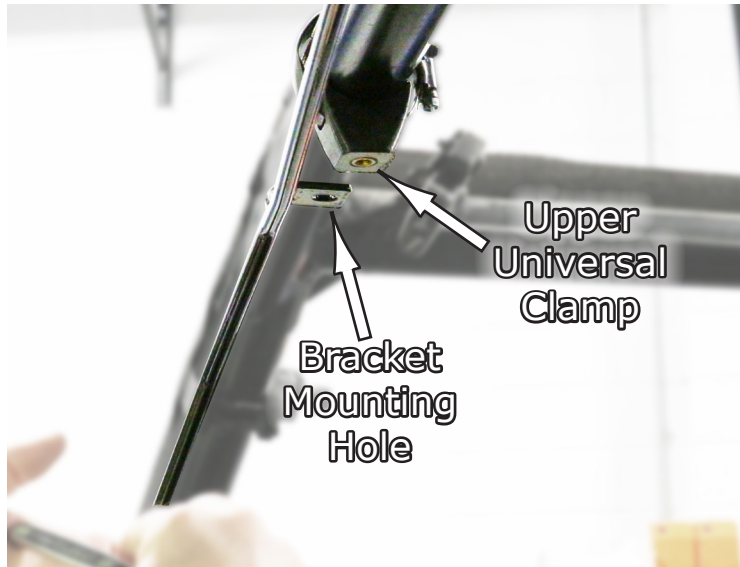
7. **Fig.8** shows both Top and Bottom frame pieces mounted to the machine. We will now mount the three (3) universal clamps to the bars to hang the Top Frame. **Fig.8** also shows the three (3) locations of the clamps and how the Top Frame mounts to the Clamps as well. Then we will hook up the hinge after that.



**Fig.8**

8. First we'll install the upper clamp that holds the top of the frame. Line the clamp up to the frame bracket hole, install using the provided hardware then snug but not too tight until all are installed.

**Fig.9** shows the frame and the clamp ready to be attached.



**Fig.9**



9. Install frame to clamp using the M8x16 Button Head Bolt, **Item "F"**, provided in your kit. See **Fig.10**.

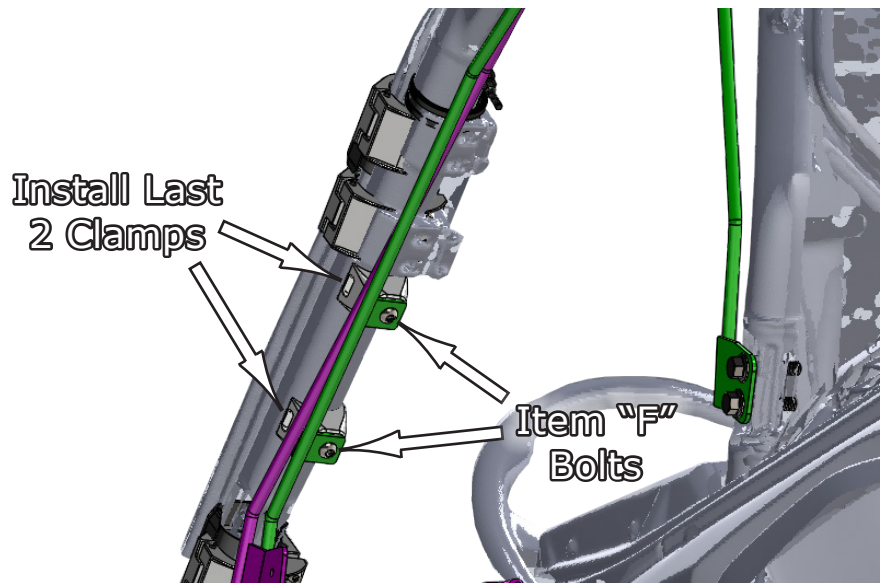


**Fig.10**



10. Then continue to install the other two (2) clamps on the frame as shown, using the same **Item "F"** bolts as the first clamp. See **Fig.11**.

After these two are installed, tighten all clamp and frame bolts securely.



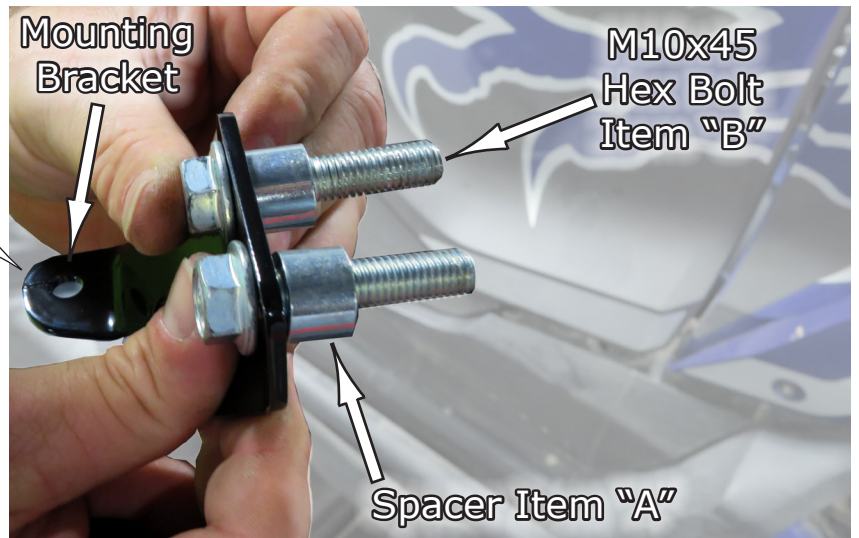
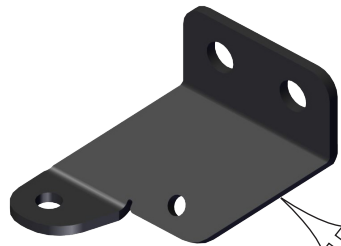
**Fig.11**

11. Next you will attach the top hinge to the frame of the machine. First remove the factory bolts on the upper frame bar as shown in **Fig.12**.

12. Then find the hinge **Mounting Bracket** from the **Mounting Kit** provided, the M10x45 Hex Bolt **Item "B"**, and the Spacer **Item "A"** provided in your kit. Then assemble the bolts through the bracket, and slide the Spacers onto the bolts, as shown in **Fig.13**.

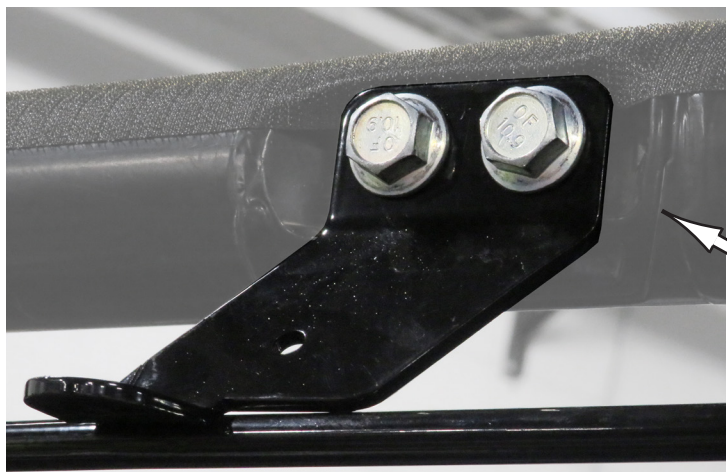


**Fig.12**

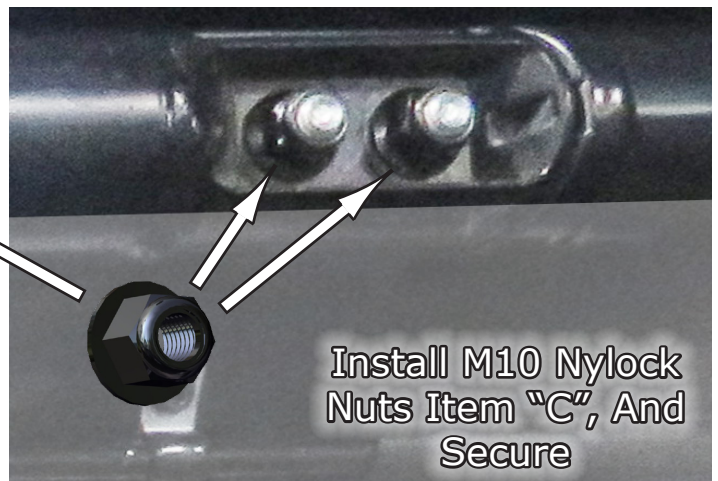


**Fig.13**

13. Now install the Bracket Assembly onto the machine using the M10x45 Nylock Nuts, **Item "C"**, as shown in **Fig.14-15** and secure.



**Fig.14**



**Fig.15**

14. After the bracket is mounted on the vehicle frame, you will now hook up the upper door frame using the Loop Clamp item "J", the M6x20 Hex Bolt item "K" and the M6 Nylock Nut item "G" to the bracket as shown in Fig.16.

Be sure to install the Loop Clamp on the rod in the orientation shown also shown in Fig.16. .

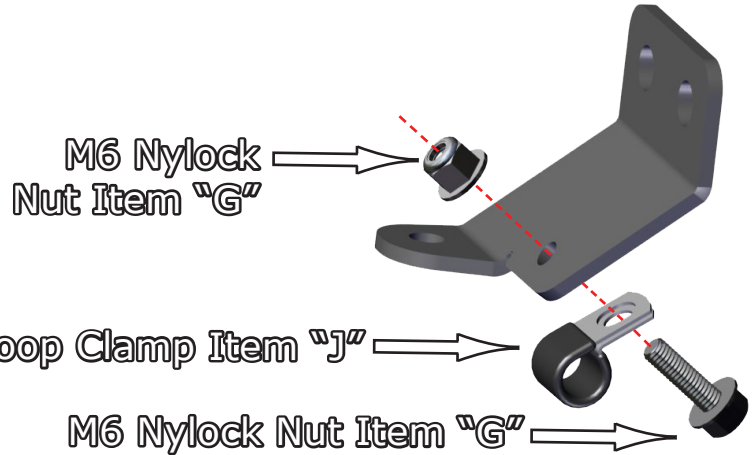


Fig.16

15. Fig.17 shows the bracket hooked up and ready.



Fig.17

16. After the frame is installed, you can now install the Fabric Shroud onto the Rod Frame. To do this, it simply hooks and snaps around the rod framing with the plastic hook clips sewn along the edges of the Shroud. See **Fig.18-19**.



**Fig.18**



**Fig.19**



17. Once you have snapped the hooks onto the Rod Frame, now wrap all flaps onto the vehicle frame where you installed the Hook & Loop tape in the beginning steps of this installation. See **Fig.20**.



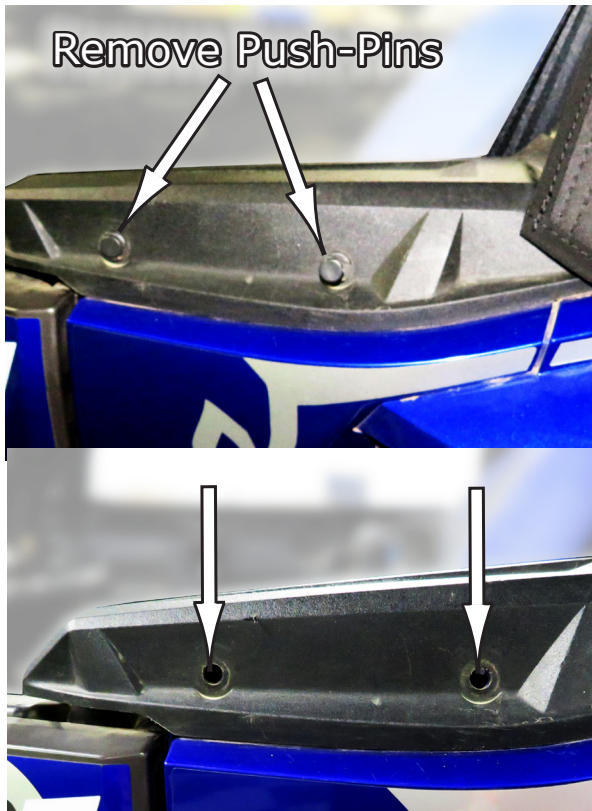
**Fig.20**



18. Now remove the Push-Pins on the small door cover as shown in **Fig.21**. You reinstall them later.

19. Next, install the outer window panel onto the Lower Window Frame rod and wrap flaps around the frame to attach to hook and loop on the panel. Then install the Lower Frame onto the door using the existing holes and the one you drilled earlier in the door panel.

You will install using the M6x25 **Item”D”**, Hex Bolts and the M8x55 **Item”E”** Hex Bolts provided in your kit.

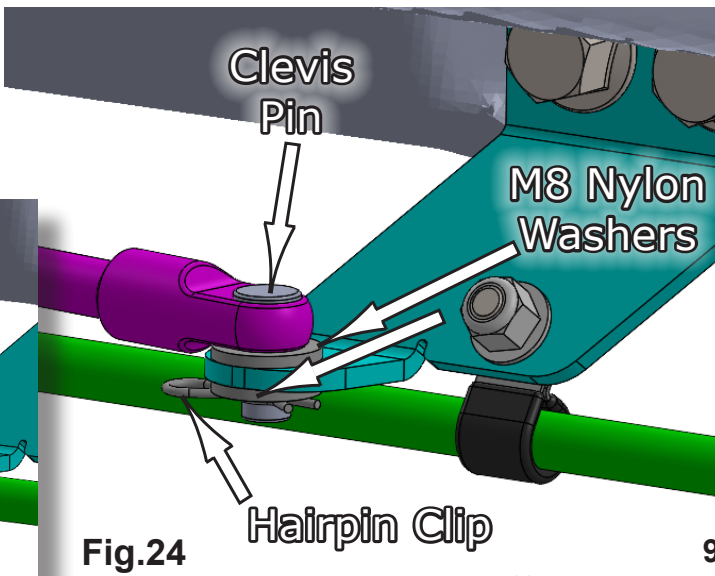
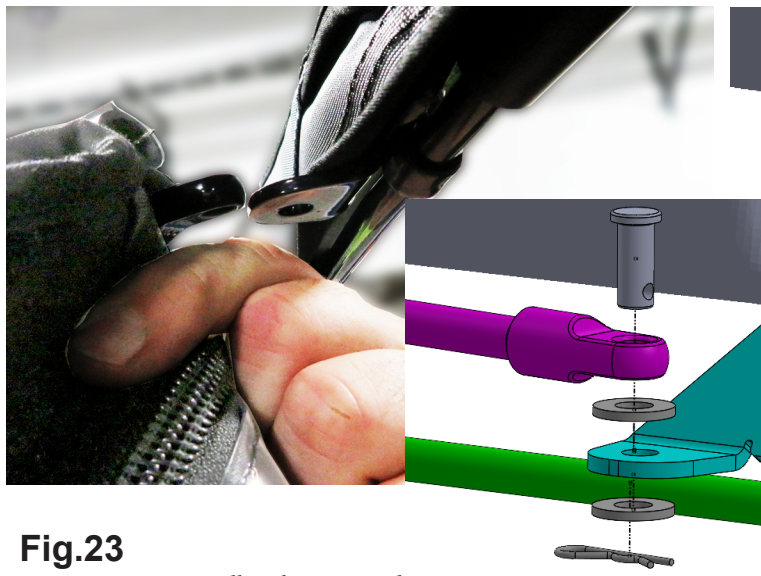


**Fig.21**



**Fig.22**

20. Now you can install the hinge at the top of the window using (2) Nylon Washers, **Item”L”**, (1) Clevis Pin, **Item”M”** and (1) Hairpin Clip, **Item ”N”** provided in your kit. These will be assembled in the order shown in **Fig.23-24**.



21. Once the Hinge is installed, you can now replace the (2) Push-pins you removed previously, by running them through the canvas eyelets. See Fig.25.

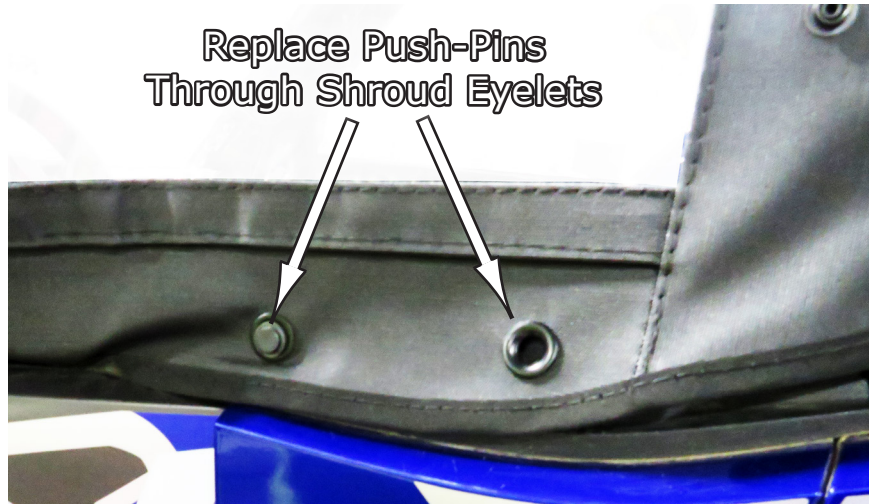


Fig.25

22. Next you will need to install the small corner filler panel before snapping up the window to the vehicle frame.

First, make sure you have applied Hook & Loop tape to the bars indicated in Fig.26, as this little panel will be using it to attach to the vehicle.

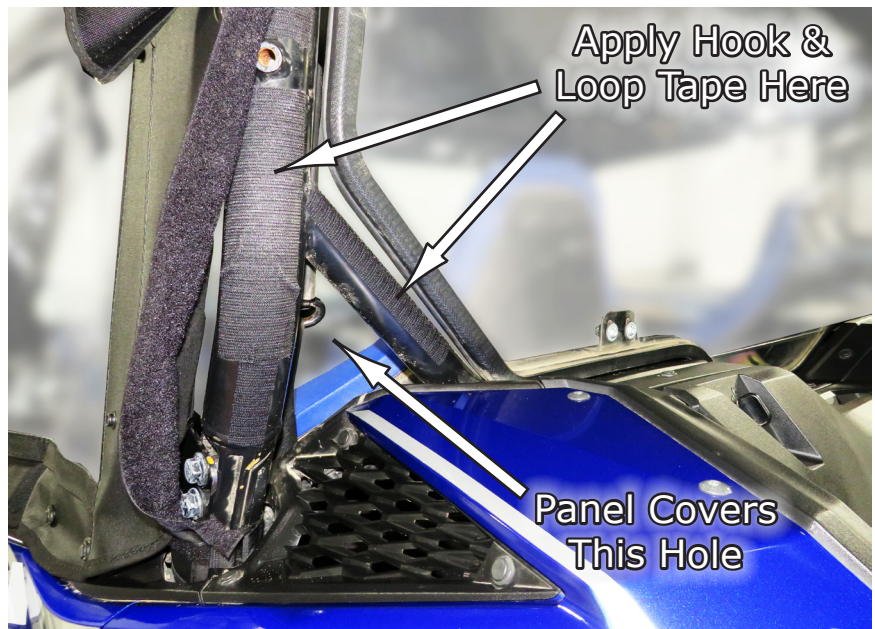


Fig.26



23. Then, find the small corner filler panel and apply it onto the Hook & Loop Tape as shown in Fig.27.



Fig.27

24. After the corner panel is installed, then snap up the side window to the vehicle frame as shown in Fig.28.



Fig.28

Once you have one side complete, repeat these same steps for the opposite side for installation.





**Liability Statement**

SuperATV's® products are designed to best fit user's ATV/UTV under stock conditions. Adding, modifying, or fabricating any factory or aftermarket parts will void any warranty provided by SuperATV® and is not recommended. SuperATV's® products could interfere with other aftermarket accessories. If user has aftermarket products on machine, contact SuperATV® to verify that they will work together.

Although SuperATV® has thousands of satisfied customers, user should be aware that installing lift kits, long travel, or suspension kits, tires, etc. will change the ride of machine and may increase maintenance and part wear. Operating any off-road machine while, or after, consuming alcohol and/or drugs increases risk of bodily harm or death. No warranty or representation is made as to this product's ability to protect user from severe injury or death. SuperATV® urges operators and occupants to wear a helmet and appropriate riding gear at all times.

By purchasing and installing SuperATV® products, user agrees that should damages occur, SuperATV® will not be held responsible for loss of time, use, labor fees, replacement parts, or freight charges. SuperATV®, nor any 3rd party, will not be held responsible for any direct, indirect, incidental, special, or consequential damages that result from any product purchased from SuperATV®. The total liability of seller to user for all damages, losses, and causes of action, if any, shall not exceed the total purchase price paid for the product that gave rise to the claim.

SuperATV® will warranty only parts provided by SuperATV®. Any damage or problems with OEM housings, bearings, seals, or other manufacturers' products will not be covered by SuperATV®. SuperATV® parts and products are not warrantied if item was not installed properly, misused, or modified.

Installing, adding, modifying, or fabricating any factory or aftermarket product to your ATV/UTV may violate certain local, state, and federal laws. Be advised that laws vary depending on town, city, county, state, etc. Use of certain products on public streets, roads, or highways may be in violation law. The Buyer is solely and exclusively legally and personally responsible for any violation of the law by the installation or use of the product. You must abide by all local, state, and federal laws, including but not limited to vehicle safety, traffic laws, and ordinances. It is your responsibility to know the laws and how they apply to you.

The Buyer is responsible to fully understand the capability and limitations of his/her vehicle according to manufacturer specifications, warnings and instructions and agrees to hold SuperATV® harmless from any damage resulting from failure to adhere to such specifications, warnings and/ or instructions. The Buyer is also responsible to obey all applicable federal, state, and local laws and ordinances when operating his/her vehicle while using this product, and the Buyer agrees to hold SuperATV® harmless from any violation thereof.

If you have any problems/questions on this kit, contact us by email at [superatv.com](http://superatv.com).

**Need help with your installation?**



[sales@superatv.com](mailto:sales@superatv.com)



[www.superatv.com](http://www.superatv.com)



1-855-743-3427



8:00am - 9:00pm EST M-Th  
8:00am - 7:00pm EST Friday  
9:00am - 2:00pm EST Saturday

*Thank You  
For Choosing*



**Like SuperATV on Facebook to keep up to date on new products!**