



**SHOP BY VEHICLE**



0

# INSTALL INSTRUCTIONS FOR 75-5190



*PRINT*

## BEFORE YOU START

Note:

This intake kit may not fit with the following Aftermarket

Parts installed:

Body Lift or Lowering Kit

Custom Hood

## REQUIRED TOOLS

7mm, 10mm, 13mm Wrench, 5/16" Nut Driver or Flat Blade Screwdriver, Pin Removal Tool or Flat Blade Screwdriver, T15, T20 Torx Bit, Phillips Screwdriver, 5/32" or 4mm Allen Wrench, 1 Pair of Pliers or similar tool, Topside Engine Creeper recommended.

Please read the entire product guide before proceeding. Note: Approximate Install Time: 2 Hr 00 Mins. Ensure all parts are present. If you are missing any of the components, call our customer support at (909) 947-0015. Do not work on your vehicle while the engine is hot. Make sure the engine is turned off and the vehicle is in Park or the Parking Brake is set.

**ENTER TO WIN**



Hi. Need any help?



ITEM NO.	PART NUMBER	DESCRIPTION	QTY.
A	AL14428-00	Airbox, 75-5190	1
B	AI2962-00	Mounting Bracket, 75-5190	2
C	AI2961C-00	Lid Seal, 75-5190	1
D	AI2963-00	Clear Lid, 75-5190	1
E	KF-1099A	Air Filter, 75-5190	1
F	AL1442-00	Intake Tube, 75-5190	2
G	AI2201-00	BHCS, M4 x .7 x 12mm Long, 18-8 SS	4
H	AG1007-00	Hose Clamp, #56	2

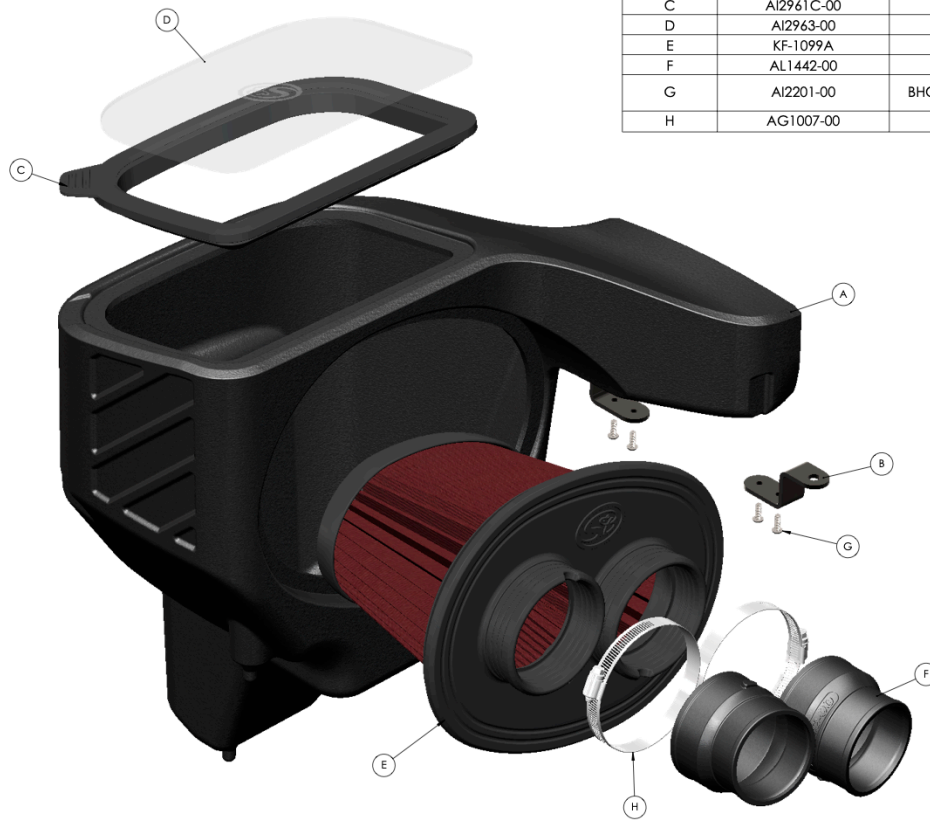

## STEP 1

Start by loosening the hose clamps and removing the 2 bolts shown in the picture.

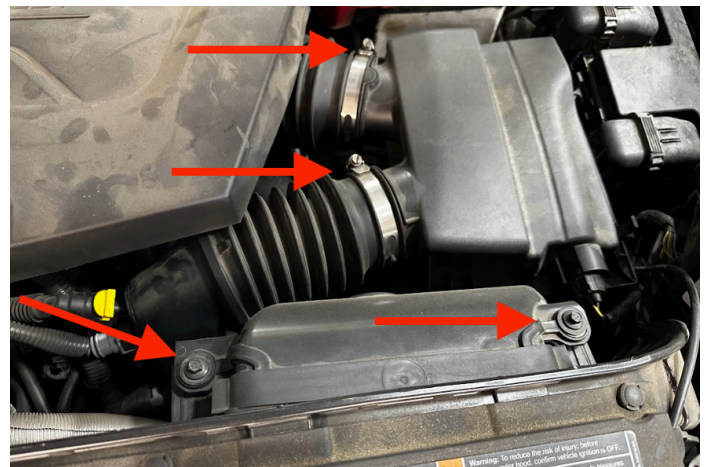

## STEP 2

Remove the IAT sensor.

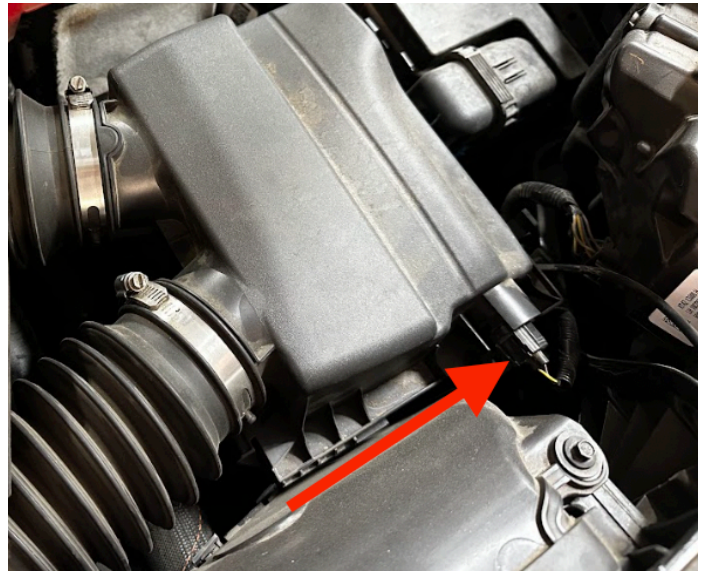

## STEP 3

Disconnect the tubes attached to the airbox, then remove the stock airbox.



## STEP 3 (IMAGE 2)





## STEP 4

Install the S&B air filter into the S&B airbox. Then attach the hose clamps onto the flanges.

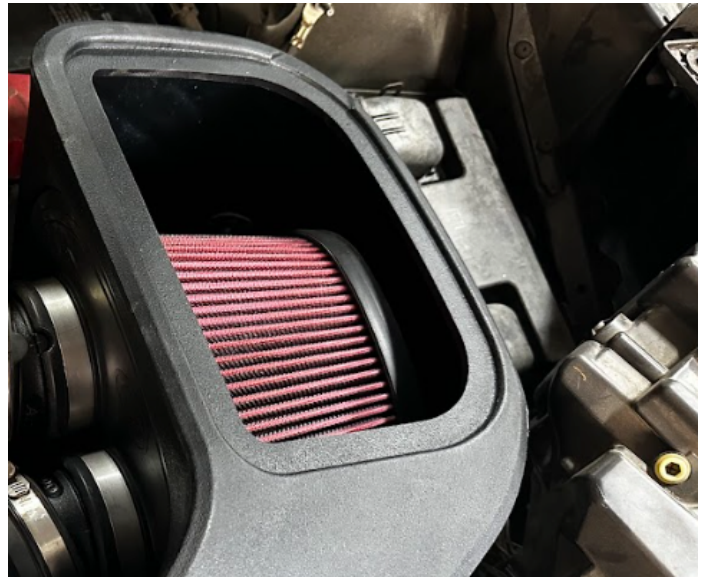

## STEP 5

Install the S&B provided tubes into the S&B air filter. Then, tighten down the hose clamps.



## STEP 6

Using the provided hardware, install the two brackets onto the S&B air box.





## STEP 7

Remove the IAT sensor from the stock air box.



## STEP 8

Install the IAT sensor onto the S&B air box. Make sure the tab is backed up all the way to the ramp as shown in the picture.



## STEP 9

Connect the IAT sensor then install the S&B air box into the vehicle.

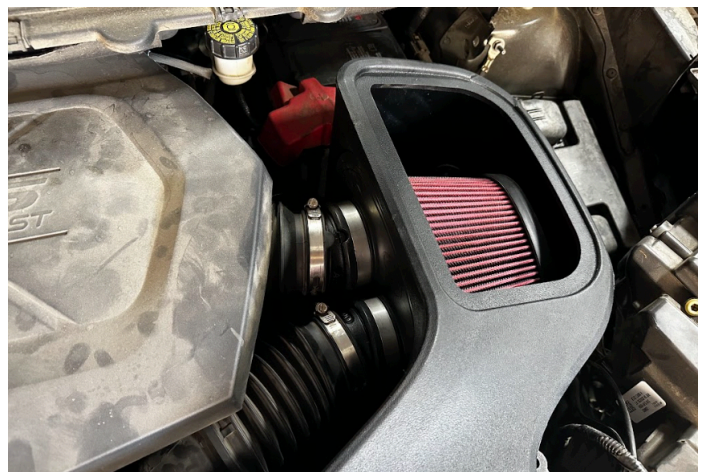

## STEP 10

Tighten down both hose clamps on the tubes, then reinstall the two screws you remove earlier.



## STEP 11

Remove the protective covering from both sides of the S&B clear lid. Then install it into the lid seal.

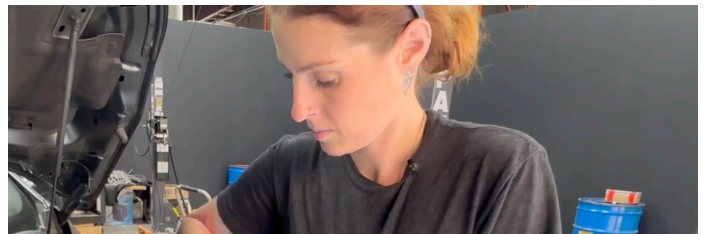
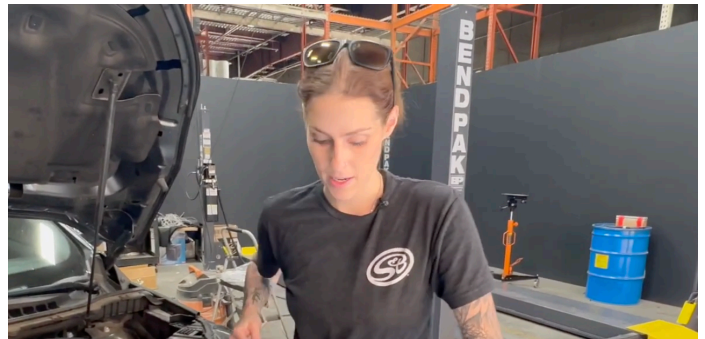

## STEP 11 (IMAGE 2)

## STEP 12

Install the clear lid onto the S&B air box.





