



**DOWNLOAD COLOUR
INSTALL MANUALS AT
www.bddiesel.com**



BD Ram 5.7L HEMI Exhaust Manifold Kit

1041463	Exhaust Manifold Kit (2009-24 RAM 1500 "Classic")*
1041467	Exhaust Manifold Kit (2019-24 RAM 1500 DT "New Body")*
1041464	Passenger Side Single Kit (2009-24 RAM 1500 "Classic")*
1041469	Passenger Side Single Kit (2019-24 RAM DT "New Body")*
1041465	Driver Side Single Kit (2009-24 All RAM 1500)*

*See Vehicle Fitment table for additional model fitment detail

Vehicle Fitment

Vehicle Model	App. Year	Full Kit	Pass Side	Driver's Side
Ram 1500 5.7L (DS "Classic" Only*)	2009-2024	1041463	1041464	1041465
Ram 1500 5.7L (DT Body Only)	2019-2024	1041467	1041469	1041465
Ram 2500 5.7L	2009-2018	1041463	1041464	1041465
Ram 3500 5.7L	2013-2018	1041463	1041464	1041465
Ram 3500 5.7L Cab and Chassis	2011-2015	1041463	1041464	1041465



*DS models labeled as "Classic" from 2019 model year onward

Table of Contents





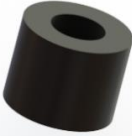

- Vehicle Fitment2
- Table of Contents.....2
- Kit Contents3
- Introduction4
- Tools Required for Installation4
- Heat Shield Replacement4
- Installation.....5
 - OEM Exhaust Manifold Removal5
 - Right Side Manifold Removal (Passenger Size).....6
 - Right Side Manifold Installation (Passenger Side)7
 - Left Side Manifold Removal (Driver's Side).....8
 - Left Side Manifold Installation (Driver's Side).....9
- Tech Tip.....11

Kit Contents



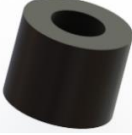

1041463 Full Exhaust Manifold Kit (DS "Classic")

1401464	1401466	1401465	1401467	1403009	1451469
					
PS Exh Manifold	PS Exh Gasket	DS Exh Manifold	DS Exh Gasket	Bolt Spacer	Fastener Kit **See Table**
Qty: 1	Qty: 1	Qty: 20	Qty: 10	Qty: 20	Qty: 2

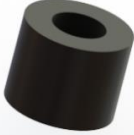

1041467 Full Exhaust Manifold Kit (DT)

1401469	1401466	1401465	1401467	1403009	1451469
					
PS Exh Manifold	PS Exh Gasket	DS Exh Manifold	DS Exh Gasket	Bolt Spacer	Fastener Kit **See Table**
Qty: 1	Qty: 1	Qty: 20	Qty: 10	Qty: 20	Qty: 2

1041464 Passenger Side Exhaust Manifold Kit (DS "Classic")



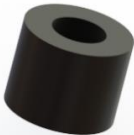
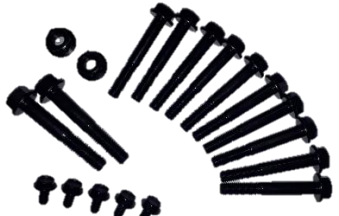

1401464	1401466	1403009	1451469
			
PS Exh Manifold	PS Exh Gasket	Bolt Spacer	Fastener Kit **See Table**
Qty: 1	Qty: 1	Qty: 10	Qty: 1

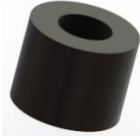
1041469 Passenger Side Exhaust Manifold Kit (DT)

1401469	1401466	1403009	1451469
			
PS Exh Manifold	PS Exh Gasket	Bolt Spacer	Fastener Kit **See Table**
Qty: 1	Qty: 1	Qty: 10	Qty: 1

1041465 Driver Side Exhaust Manifold Kit (DS & DT)			
1401465	1401467	1403009	1451469
			
DS Exh Manifold	DS Exh Gasket	Bolt Spacer	Fastener Kit **See Table**
Qty: 1	Qty: 1	Qty: 10	Qty: 1

Below table contains contents of fastener kit found in above kits.

1451469 Fastener Kit Table			
M8 x 60mm Hex Bolt	3/8" x 2.5" Hex Flange Bolt	3/8" Hex Flange Nut	M6 x 12mm Hex Flange Bolt
			
Qty: 10	Qty: 2	Qty: 2	Qty: 5

Introduction

BD's exhaust manifold kit for the Ram 5.7L Hemi pick-up trucks replaces the problematic OEM manifold. The BD Manifold has a uniform casting thickness, and features longer bolts and spacers to reduce the stress on the bolts, preventing them from breaking. The kits include all the required hardware and gaskets for manifold installation.

Tools Required for Installation

- 10-16mm Socket & Wrench
- 7/8" Deep Socket
- Screwdriver
- Torque Wrench
- Retainer Clip Remover
- Broken Stud Removal Tool
- 90 degree hand drill

Heat Shield Replacement

If replacement OEM heatshields are desired, the following MOPAR® part numbers are used for both left and right manifolds:

Vehicle Model	App. Year	Heat Shield Part No.
Ram 1500 5.7L (DS "Classic" Only)	2009-2024	4893964AC
Ram 1500 5.7L (DT Body Only)	2019-2024	53032968AF
Ram 2500 5.7L	2009-2018	4893964AC
Ram 3500 5.7L	2013-2018	4893964AC
Ram 3500 5.7L Cab and Chassis	2011-2015	4893964AC

Installation

OEM Exhaust Manifold Removal

Disconnect the vehicle battery and safely position the vehicle on a hoist before installation for safety.

Remove the driver and passenger side fender-liners and wheels.

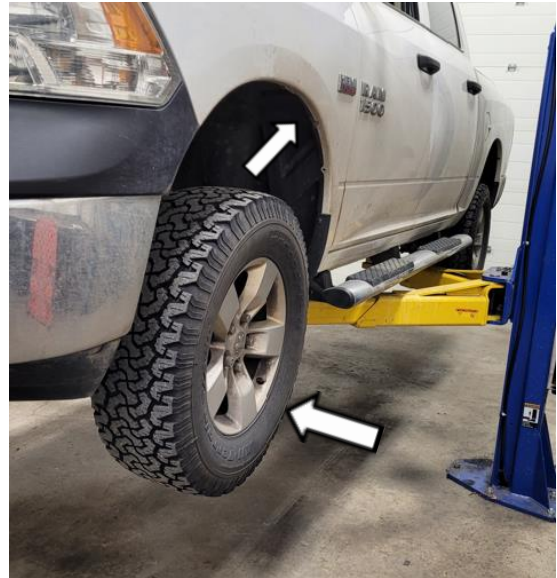

Apply penetrating fluid on all exhaust pipe retaining, heat shield mounting bolts, and studs.



Remove the 4 flange bolts from passenger and driver side manifold to collector flange using **9/16 in** socket.



To gain more space for removal of the manifold, disconnect the mid-pipe exhaust hanger as shown.



Right Side Manifold Removal (Passenger Side)

Using a **10 mm** socket wrench remove the four heat shield nuts (1).

Carefully remove the heat shield. It will be reused.

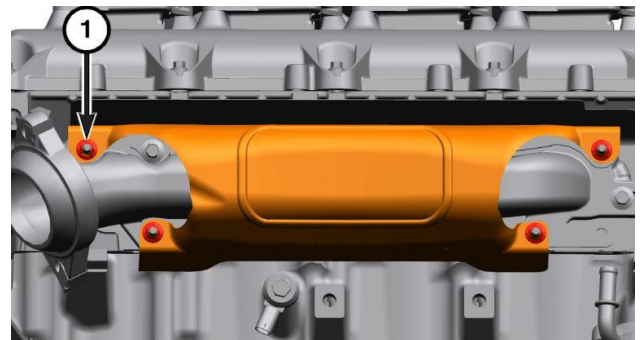

Use size **10 mm & 13 mm** socket to undo the manifold bolts.

Remove the manifold and gasket from the vehicle carefully.

Note: if needed, remove all broken bolts/studs from the engine block.



Clean and Inspect mating surfaces of exhaust manifold for flatness with a straight edge.

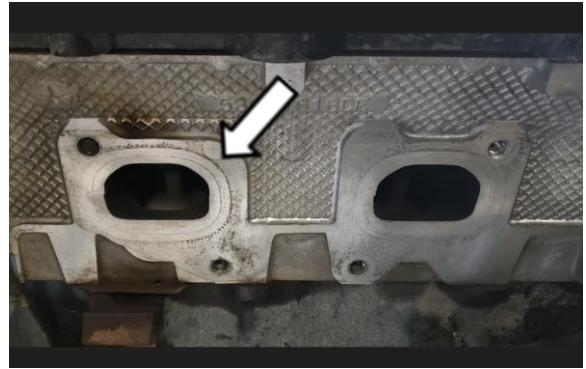

Right Side Manifold Installation (Passenger Side)

Install the exhaust manifold and gasket, using the supplied M8 bolts along with the spacers (1403009) as shown, into all available bolt holes.

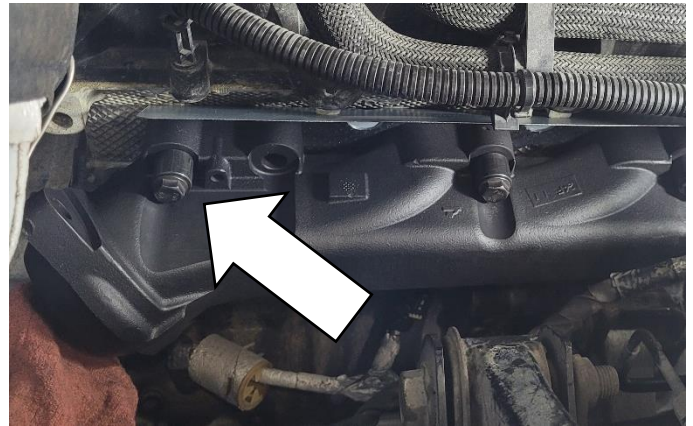

Using the sequence shown, tighten the bolts as shown.

Torque to **25 N-m (18 ft-lb)**.

Note: early production has 9 bolts, and late production has 10 bolts.

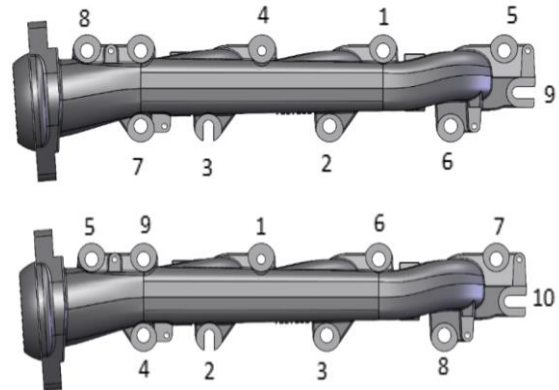

Using the provided M6 bolts, install the OEM heat shield on the new mounting locations on the BD manifold.

Torque to **10 N-m (89 in-lb)**.

Note for DT only: Heat shield trimming required. See following step.

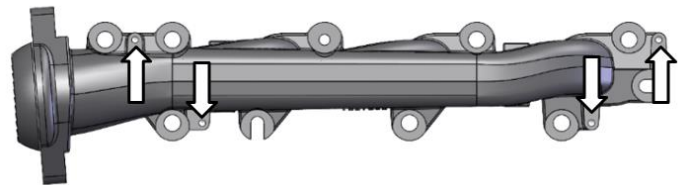

If installing on **DS “Classic”**, skip this step.

Trimming of heat shield is required for clearance of hard lines. Contact may occur between shield and line near the bottom of manifold, towards the front of the vehicle.

Trim off ~1/2” as shown and inspect for clearance as indicated by the arrow.



Left Side Manifold Removal (Driver’s Side)

Disconnecting the steering shaft linkage may help with ease of install.

Mark the steering shaft position as shown before removing the bolt.

Note: On “New Body Style” RAM 1500 **DT** trucks, disconnecting the oxygen sensor electrical connector can help move wiring out of the way.

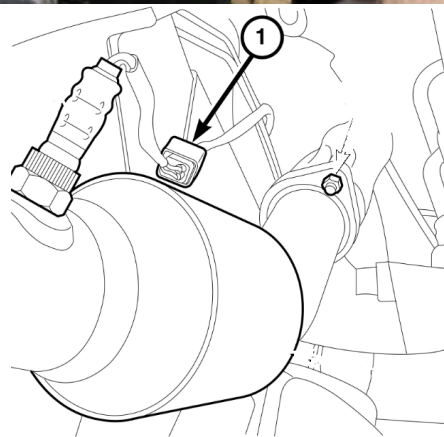
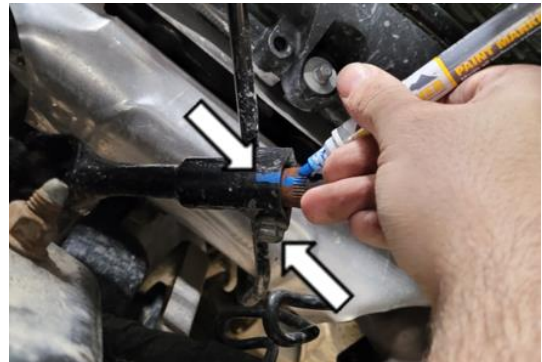

Using a **10mm** socket, remove the four heat shield nuts, and carefully remove heat shield. It will be reused.

Note: One of the nuts will secure the dipstick (1).

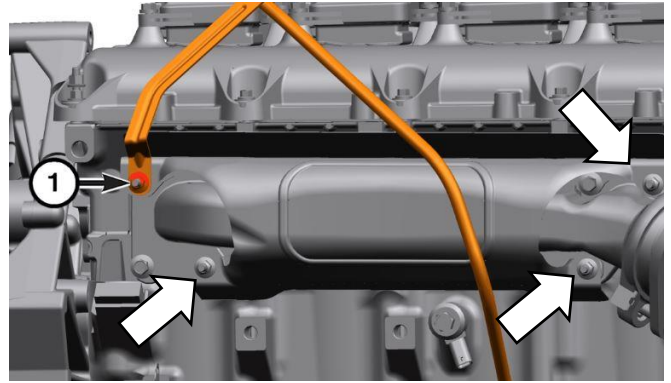

Using **10 mm & 13 mm** socket, remove the left side exhaust manifold bolts. Remove the manifold and gasket carefully

Note: if needed, remove all broken bolts/studs from the engine block.

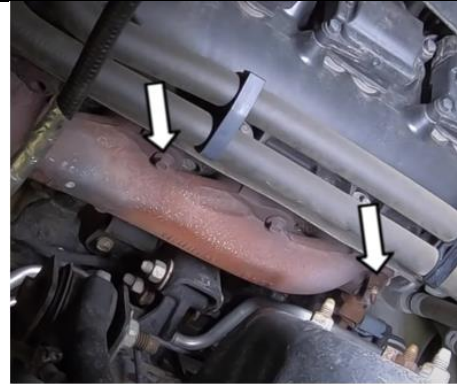

Left Side Manifold Installation (Driver's Side)

Ensure all gasket mating surfaces are clean and free of any debris.



Set the manifold into position, with the corresponding gasket. Install supplied M8 bolts and spacers, into all available bolt holes.

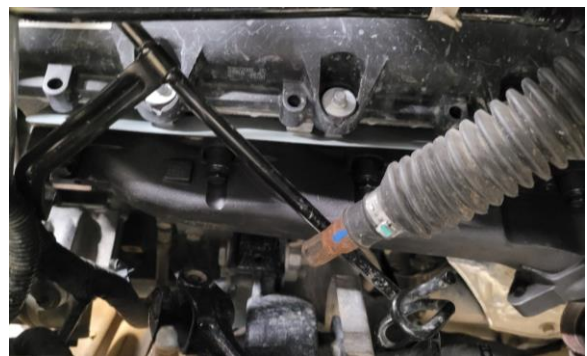

Using the sequence shown, tighten the bolts as shown.

Torque to **25 N-m (18 ft-lb)**.

Note: early production has 8 bolts, and late production has 10 bolts.

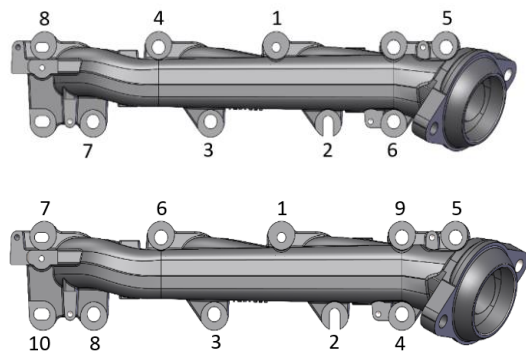

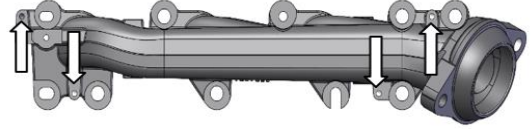

Using the provided M6 bolts (1401462), install the OEM heat shield on the new mounting locations on the BD manifold. Use size 10mm wrench.

Torque to **10 N-m (89 in-lb)**.

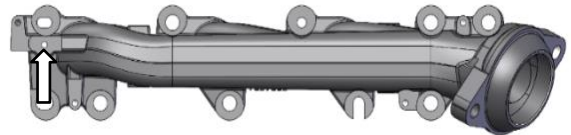

On the driver side manifold, install the dipstick support bracket onto the new mounting location using the supplied M6 bolt.

Torque to **10 N-m (89 in-lb)**.



If steering shaft was disconnected, align the previously created marking and insert the upper steering shaft into lower and tighten the bolt.

Torque to **50 N-m (37 ft-lb)**.



Check oil dipstick-for clearance against the hard lines after it was relocated.

If the dipstick is touching, gently push on it to adjust the mounting bracket.



Install the new supplied 3/8"-16x2.50 exhaust pipe retaining bolts and 3/8"-16 nuts in to both sides.

Torque to **32 N-m (24 ft-lb)**.

Note: see the tech tip below if a leak is present at this joint.



Connect the battery.
Start the engine and check for leaks
Install the inner fender liners
Install wheels

Tech Tip

Due to heat cycling of the exhaust, the exhaust flange at the manifold joint may become warped and cause a leak.

This can be remedied by:

- Allowing the engine to reach operating temperature, and torquing the bolts while the joint is hot.
- Disconnecting the joint, heating the exhaust flange, and refitting the joint.