

INSTALLATION INSTRUCTIONS
Gen 3 Portal Gear Hubs:
for 2023+ Kawasaki Teryx[®] KRX4™ 1000

- Do not discard packaging until product has been successfully installed.

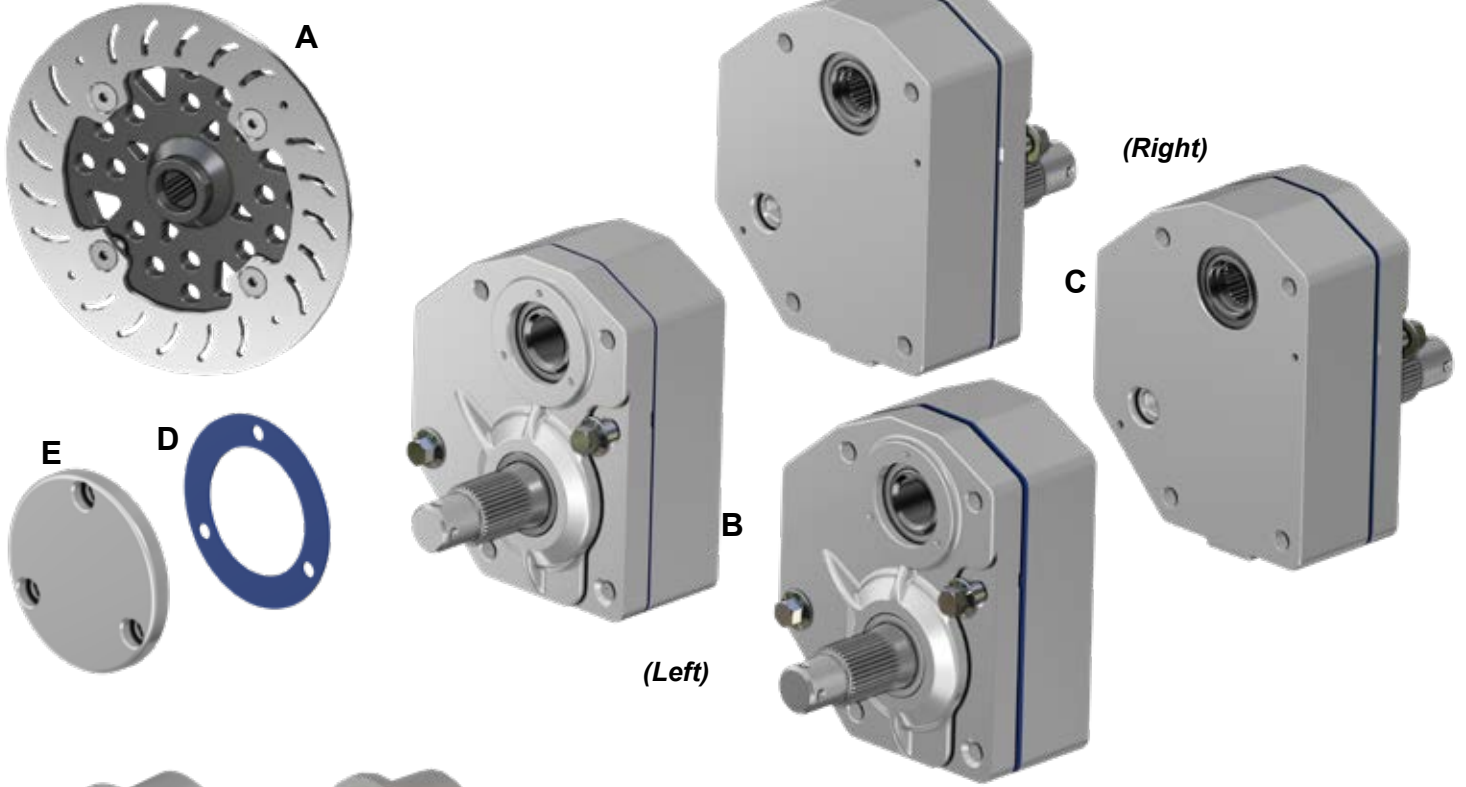

Item	Description
A	Front Rotor x 2
B	Left Gear Box x 2
C	Right Gear Box x 2
D	Gasket x 4
E	Cap x 4
F	Recessed Nut - Front Right
M	Recessed Nut - Rear Left
N	Recessed Nut - Rear Right
P	Recessed Nut - Front Left
U	Rear Rotor x 2

WHEN FILLING GEAR BOX USE ONLY SUPERATV PORTAL BLOOD. USING GREASE WILL CAUSE FAILURE OF GEARS AND BEARINGS. USING GREASE WILL VOID THE WARRANTY.

(Kit Contents continue on following pages)

Need help with your installation?

✉ sales@superatv.com 🌐 www.superatv.com

☎ 1-855-743-3427 🕒 8:00am - 8:00pm EST M-Th
 8:00am - 7:00pm EST Friday
 9:00am - 2:00pm EST Saturday

Read instructions and view illustrations before beginning.

Thank You
For Choosing
SUPERATV.COM[®]

(Kit Contents continued)



H



G



J

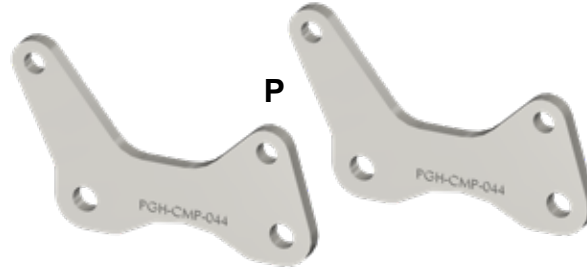

P

Steering Stop Kit

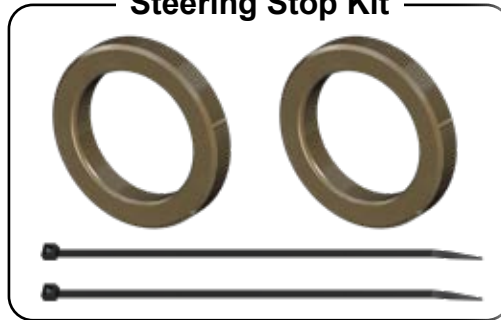

(Left)

(Right)



K



L

*Install Steering Stop Kit only if warranty Kawasaki A-Arms have **not** been installed.*

Item	Description
G	Front Caliper Mounting Plate x 2
H	Left Front Plate
J	Right Front Plate
K	Left Rear Plate
L	Right Rear Plate
P	Rear Caliper Mounting Plate x 2

Machines with SuperATV Heavy Duty Tie Rod Ends must use hardware shown when securing to Steering Arms.



M12 Nylock Nut



M10 Nylock Nut



M12 Nylock Nut

(Qty. 2 each)

(Kit Contents continued)

Item	Description
Q	Left Parking Brake Bracket
R	Right Parking Brake Bracket
S	Left Brake Cable Bracket
T	Right Brake Cable Bracket

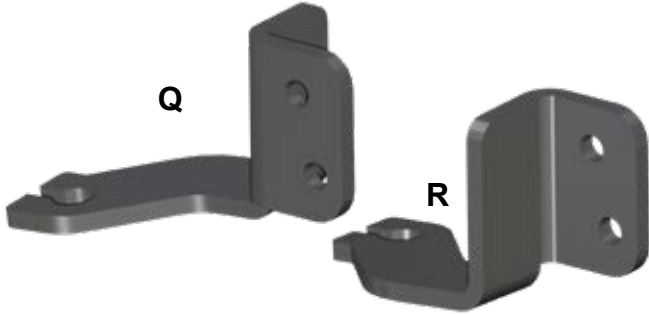

Front Brake Lines:

Length (Approx)	Location
51-3/16"	Right
39-3/16	Left



Rear Brake Line Extension x 2



Parking Brake x 2

Liability Statement

SuperATV's® products are designed to best fit user's ATV/UTV under stock conditions. Adding, modifying, or fabricating any factory or aftermarket parts will void any warranty provided by SuperATV® and is not recommended. SuperATV's® products could interfere with other aftermarket accessories. If user has aftermarket products on machine, contact SuperATV® to verify that they will work together.

Although SuperATV® has thousands of satisfied customers, user should be aware that installing lift kits, long travel, or suspension kits, tires, etc. will change the ride of machine and may increase maintenance and part wear. Operating any off-road machine while, or after, consuming alcohol and/or drugs increases risk of bodily harm or death. No warranty or representation is made as to this product's ability to protect user from severe injury or death. SuperATV® urges operators and occupants to wear a helmet and appropriate riding gear at all times.

By purchasing and installing SuperATV® products, user agrees that should damages occur, SuperATV® will not be held responsible for loss of time, use, labor fees, replacement parts, or freight charges. SuperATV®, nor any 3rd party, will not be held responsible for any direct, indirect, incidental, special, or consequential damages that result from any product purchased from SuperATV®. The total liability of seller to user for all damages, losses, and causes of action, if any, shall not exceed the total purchase price paid for the product that gave rise to the claim.

SuperATV® will warranty only parts provided by SuperATV®. Any damage or problems with OEM housings, bearings, seals, or other manufacturers' products will not be covered by SuperATV®. SuperATV® parts and products are not warranted if item was not installed properly, misused, or modified.

Installing, adding, modifying, or fabricating any factory or aftermarket product to your ATV/UTV may violate certain local, state, and federal laws. Be advised that laws vary depending on town, city, county, state, etc. Use of certain products on public streets, roads, or highways may be in violation law. The Buyer is solely and exclusively legally and personally responsible for any violation of the law by the installation or use of the product. You must abide by all local, state, and federal laws, including but not limited to vehicle safety, traffic laws, and ordinances. It is your responsibility to know the laws and how they apply to you.

The Buyer is responsible to fully understand the capability and limitations of his/her vehicle according to manufacturer specifications, warnings and instructions and agrees to hold SuperATV® harmless from any damage resulting from failure to adhere to such specifications, warnings and/ or instructions. The Buyer is also responsible to obey all applicable federal, state, and local laws and ordinances when operating his/her vehicle while using this product, and the Buyer agrees to hold SuperATV® harmless from any violation thereof.

Read ALL instructions prior to operating Portal Gear Hubs. Injury to personnel, portal gear hub, and/or machine failure may be caused by improper installation, maintenance or operation.

- It is dangerous to get under a jacked-up vehicle. The vehicle could slip off the jack and fall on you. You could be crushed. Never place any part of your body under a vehicle that is on a jack. Never start or run the engine while the vehicle is on a jack. If you need to get under a raised vehicle, take it to a service center where it can be raised on a lift.
- Hot oil can cause severe burns. Use extreme care when removing lubrication plugs and when working close to a unit that has been in operation.
- Check lube level between scheduled lube changes to insure that proper lube level is maintained. Inspect the tightness of mounting bolts, excessive heating, or any unusual noise or vibration.
- Serious personal injury may occur as a result of improperly performed maintenance, adjustments or repairs.
- Always be extremely careful when working on the portal gear hub. Always follow commonly accepted safety practices and general common sense. Never risk personal injury.
- Do not operate the portal gear hub without proper lube and correct amount.

For safe operation and to maintain the unit warranty, when changing a provided fastener for any reason, it becomes the responsibility of the person making the change to properly account for fastener grade, thread engagement, load, tightening torque and the means of torque retention.

- Mounting bolts should be periodically checked to ensure that the unit is firmly anchored for proper operation.
- These instructions are not intended to cover all details or variations in equipment, nor provide for every possible contingency to be met in connection with selection, installation, operation, and maintenance.

Should further information be desired or should particular problems arise which are not covered sufficiently for the Buyer's purpose, the matter should be referred to SuperATV®.

In the event of the resale of any of the goods, in whatever form, Resellers/Buyers will include the following language in a conspicuous place and in a conspicuous manner in a written agreement covering such sale:

The manufacturer makes no warranties or representations, express or implied, by operation of law or otherwise, as to the merchantability or fitness for a particular purpose of the goods sold hereunder. Buyer acknowledges that it alone has determined that the goods purchased hereunder will suitably meet the requirements of their intended use. In no event will the manufacturer be liable for consequential, incidental or other damages. Even if the repair or replacement remedy shall be deemed to have failed of its essential purpose under Section 2-719 of the Uniform Commercial Code, the manufacturer shall have no liability to Buyer for consequential damages.

Resellers/Buyers agree to also include this entire document including the danger, warnings and cautions above in a conspicuous place and in a conspicuous manner in writing to instruct users on the safe usage of the product.

 **When installing or removing hardware shown DO NOT USE IMPACT WRENCH. Torque to 60 ft/lbs MAX**

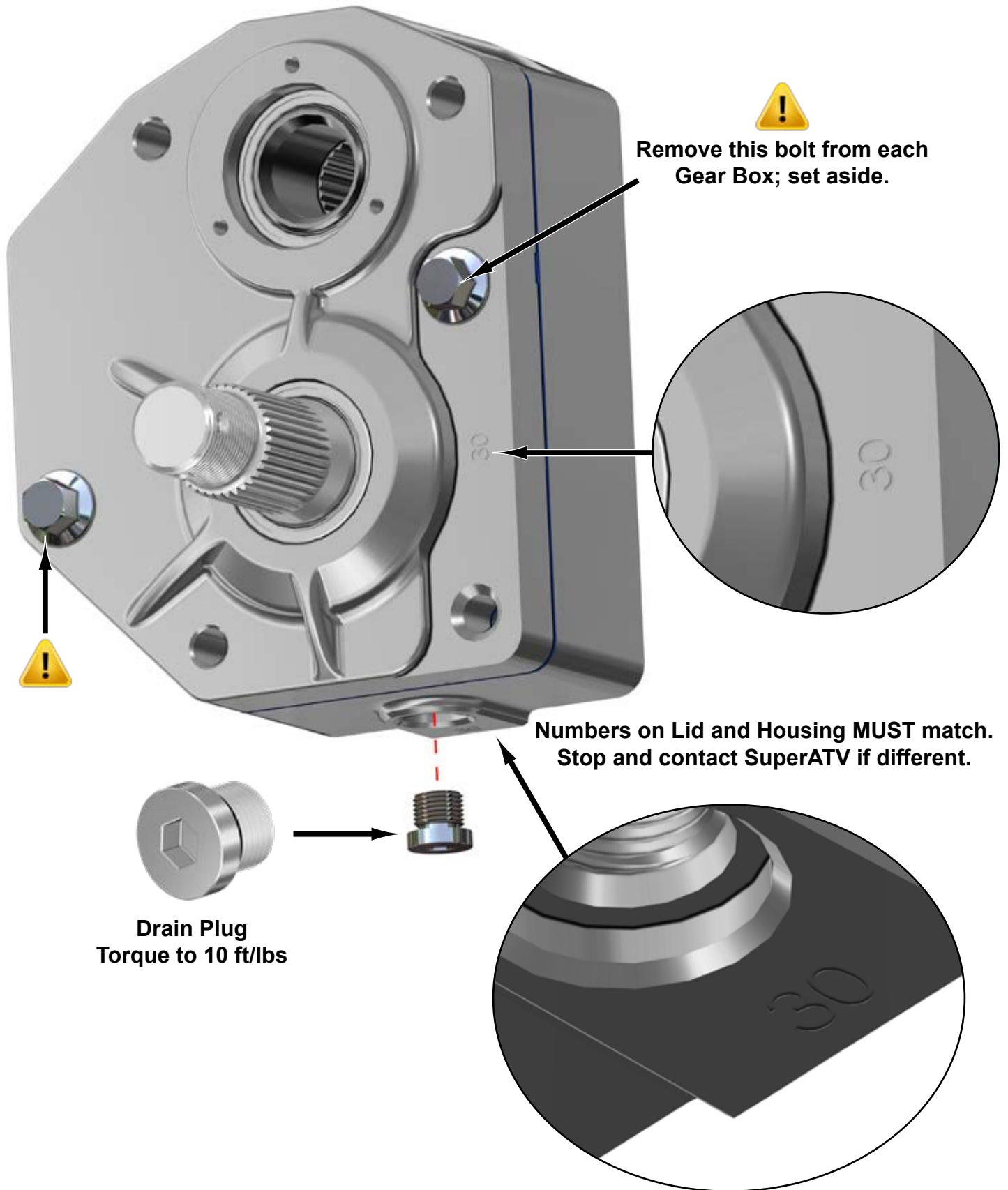

DO NOT USE IMPACT WRENCH WHEN INSTALLING ANY HARDWARE INTO HOUSING

Front Components Removal: Keep all components removed from machine.

Remove:

- Axle Nuts and Pins
- Tie Rods
- Brake Lines
- Calipers
- Knuckles
- Ball Joints from Knuckles



Steering Stop installation

*Install Steering Stop Kit only if warranty Kawasaki A-Arms have **not** been installed.*



- Install Steering Stop onto Shaft.
- Reinstall Tie Rod to Rack and Pinion. Secure Boot with provided Wire Tie.
- Repeat steps for opposite side.

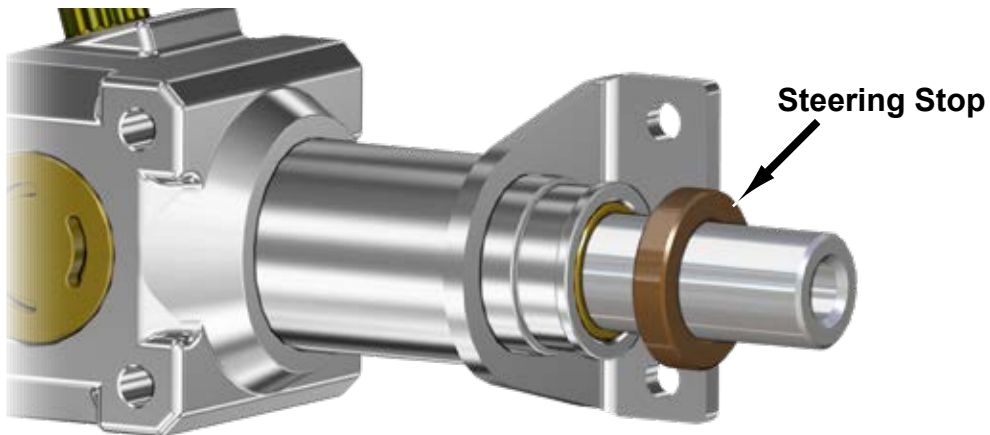

Rear Components Removal: Keep all components removed from machine.



Parking Brake Lines Removal: Keep all components removed from machine.

Reinstall applicable stock components after new Parking Brakes and Portal Gear Hubs have been installed.

- Remove hardware shown from Center Console and Console Cover.



Parking Brake Lines Removal continued:

- Remove Seat Bottoms and Seats.

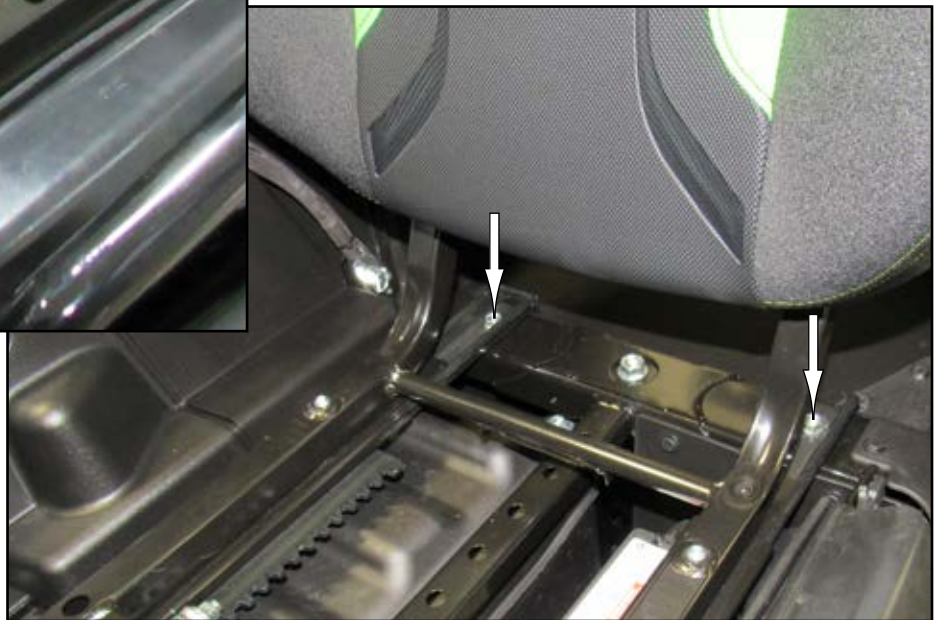

- Remove Battery Cover.



Parking Brake Lines Removal continued:

- Remove hardware shown from Control Panel.



- Remove hardware shown from Maintenance Cover.



Parking Brake Lines Removal continued:

- Remove Rear Floor Panel shown.



Parking Brake Lines Removal continued:

- Place Control Panel up and away.



- Remove Console Cover from machine.



Parking Brake Lines Removal continued:



- Remove hardware shown from Battery Cover.

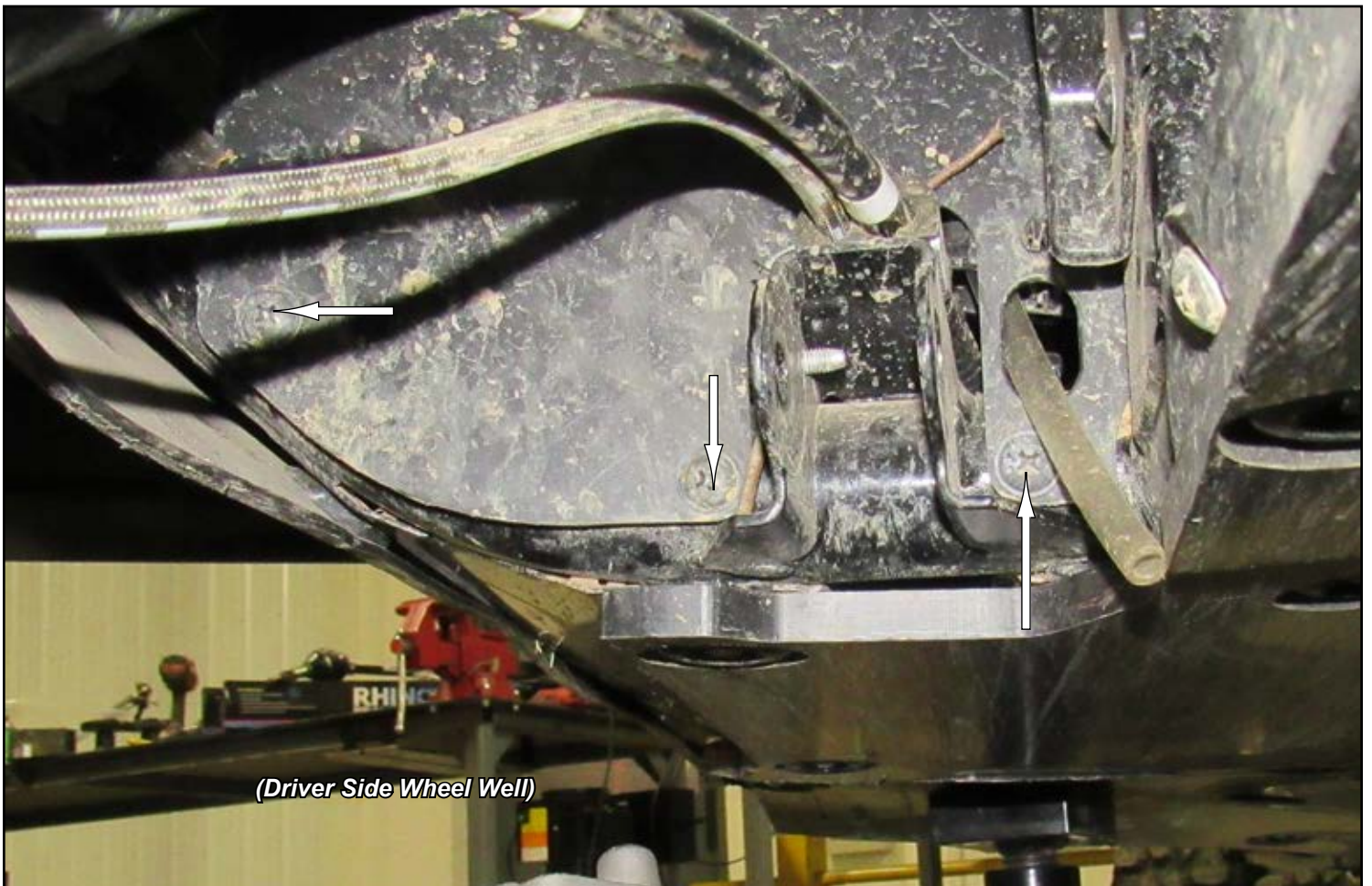

(Driver Side Wheel Well)

- Remove from Battery Cover.

Parking Brake Lines Removal continued:

- Disconnect Clamp.



- Flare Center Console out.



Parking Brake Lines Removal continued:

- Disconnect Return Spring from location shown.

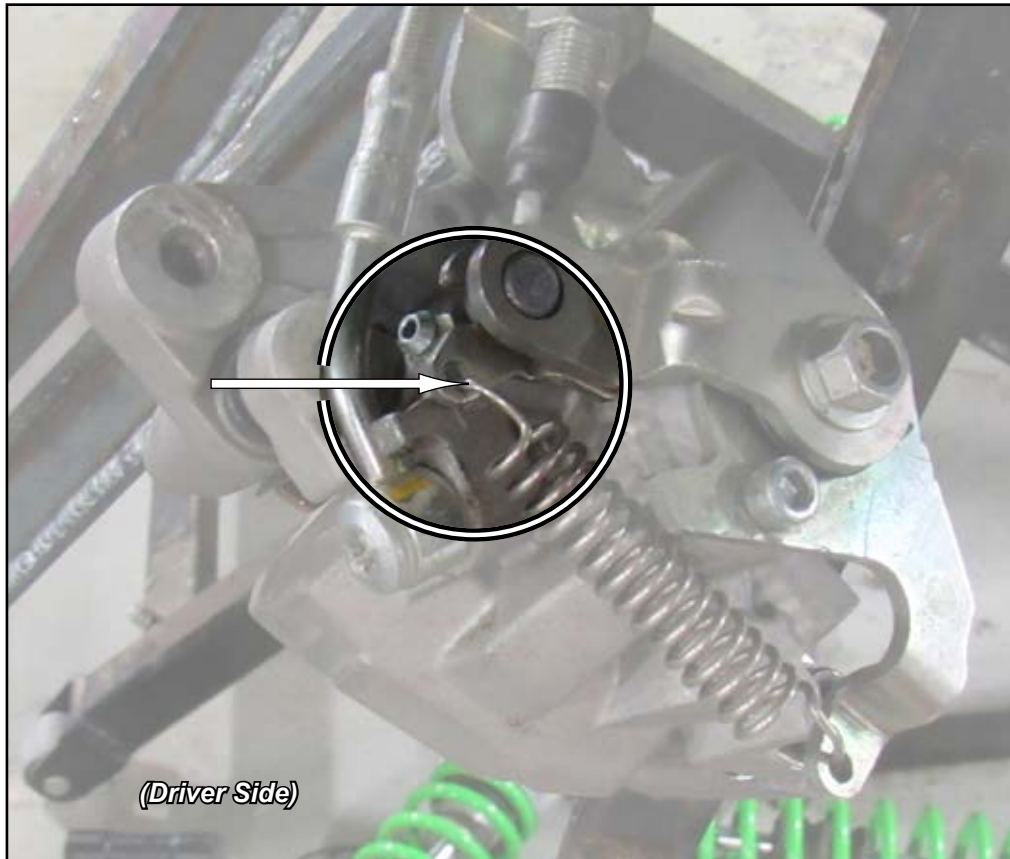

- Remove Bracket.

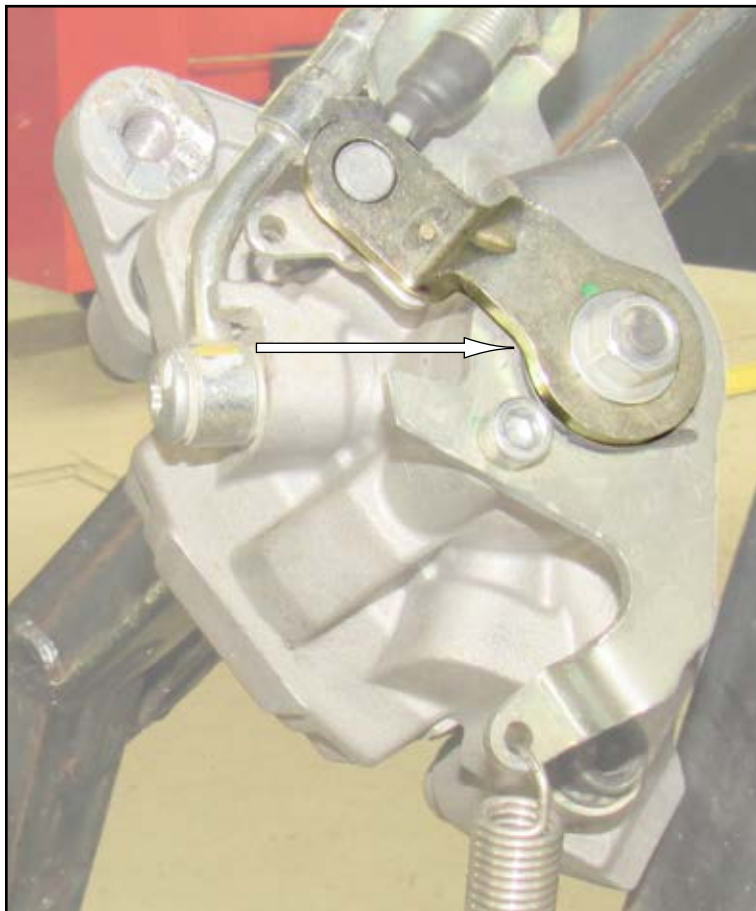

repeat for opposite side

Parking Brake Lines Removal continued:

- Disconnect Parking Brake Cables from Bracket.

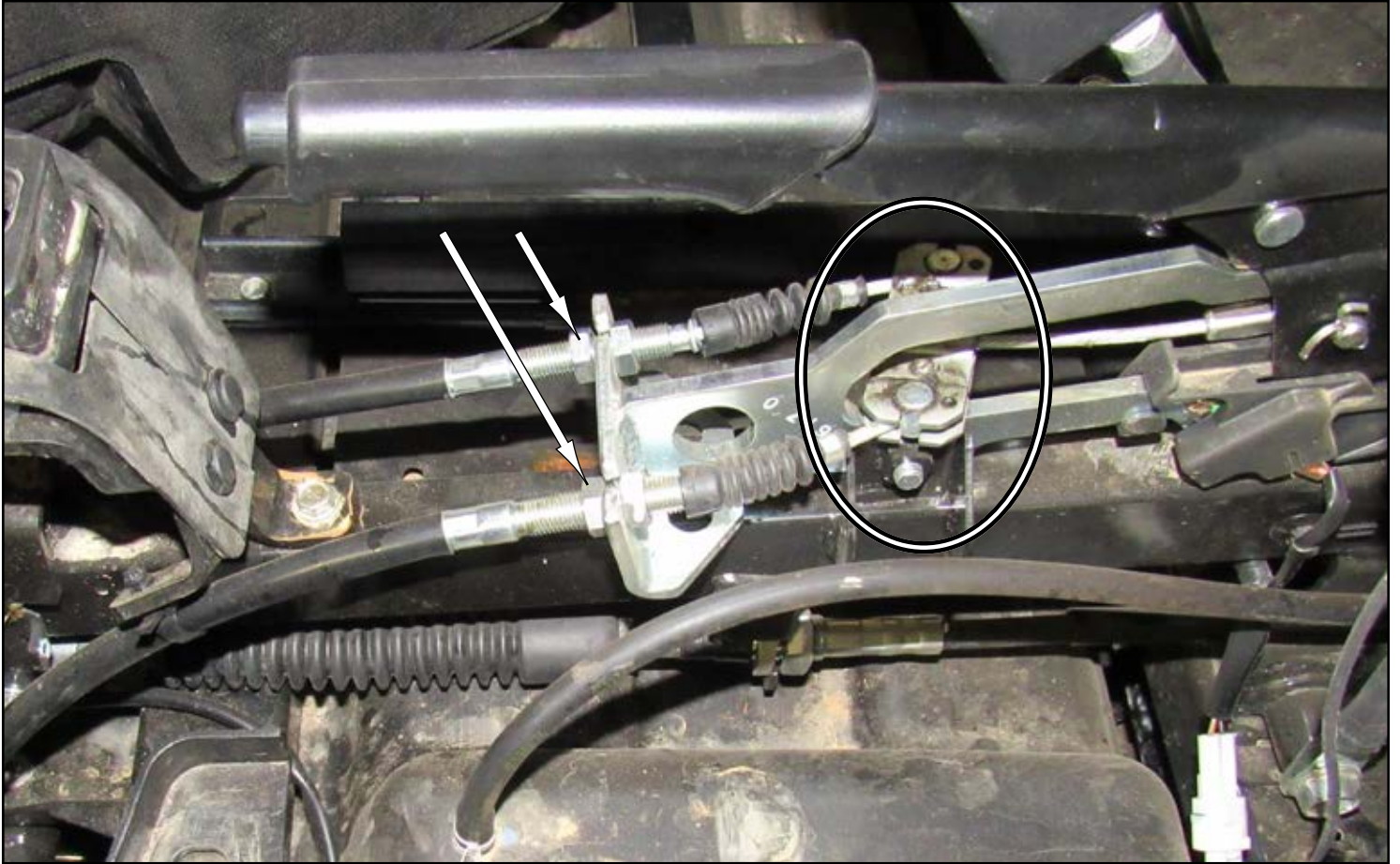

- Coil Parking Brake Cables up and place into Dash.



Parking Brake Cables install:

- Insert into stock location and route under Seat. Follow stock routing up to Parking Brake Lever.



Parking Brake Cables install continued:

- Insert into stock location and route under Gas Tank.

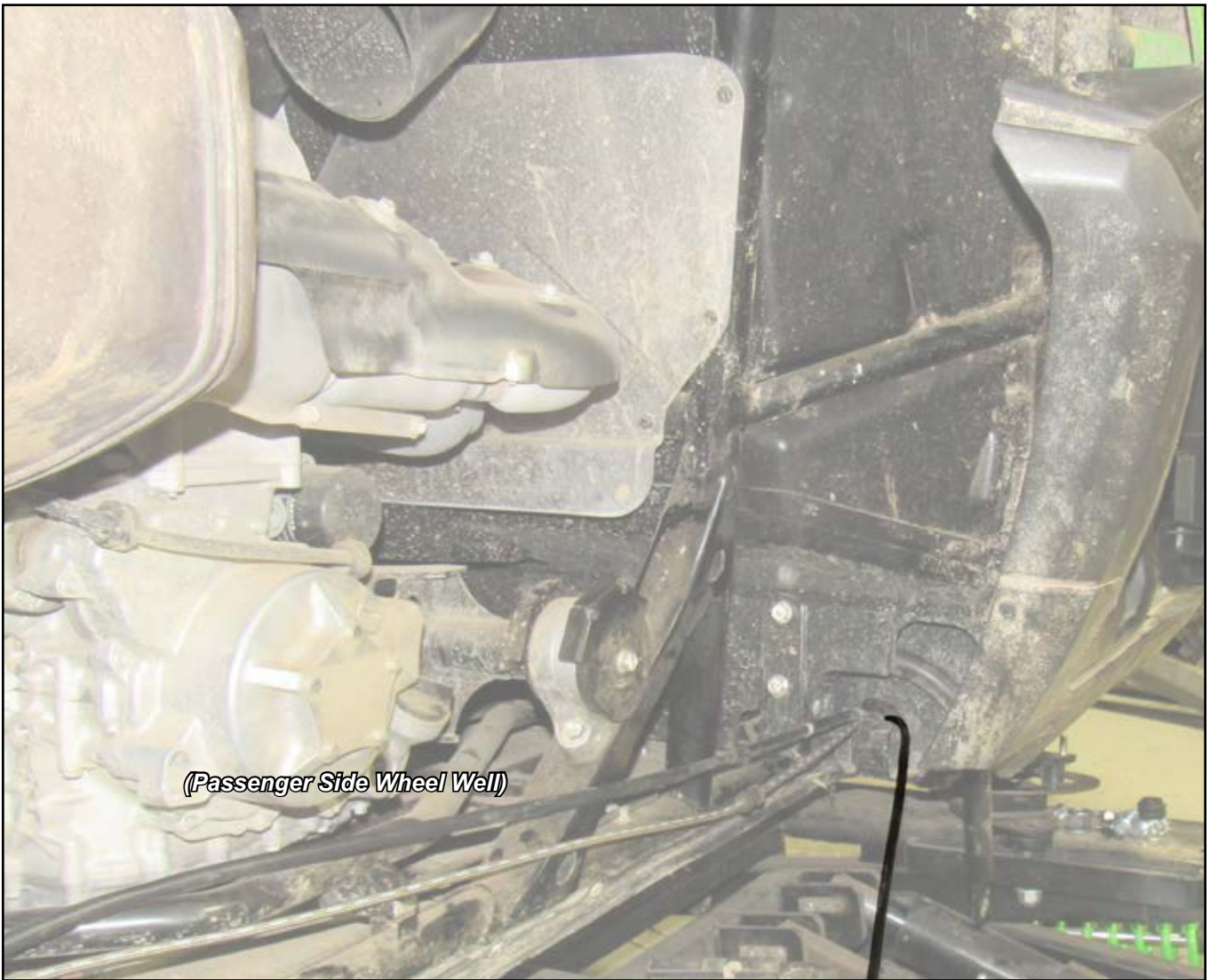

Parking Brake Cables install continued:

- Parking Brake Cable should stop against plastic in area shown. Use a long pair of needle nose pliers to grab onto. Pull up and follow stock routing to Parking Brake Lever.



Parking Brake Cables install continued:

- Secure Parking Brake Cables to Bracket. Do not tighten completely.



(Driver Side)

- Install provided Studs into Rotors (A)(U):
- See "Wheel Hub Bolt Patterns".
 - Note machines bolt pattern and lug size.
 - Set aside when complete.

Front Rotor (A) is thinner than Rear Rotor (U).

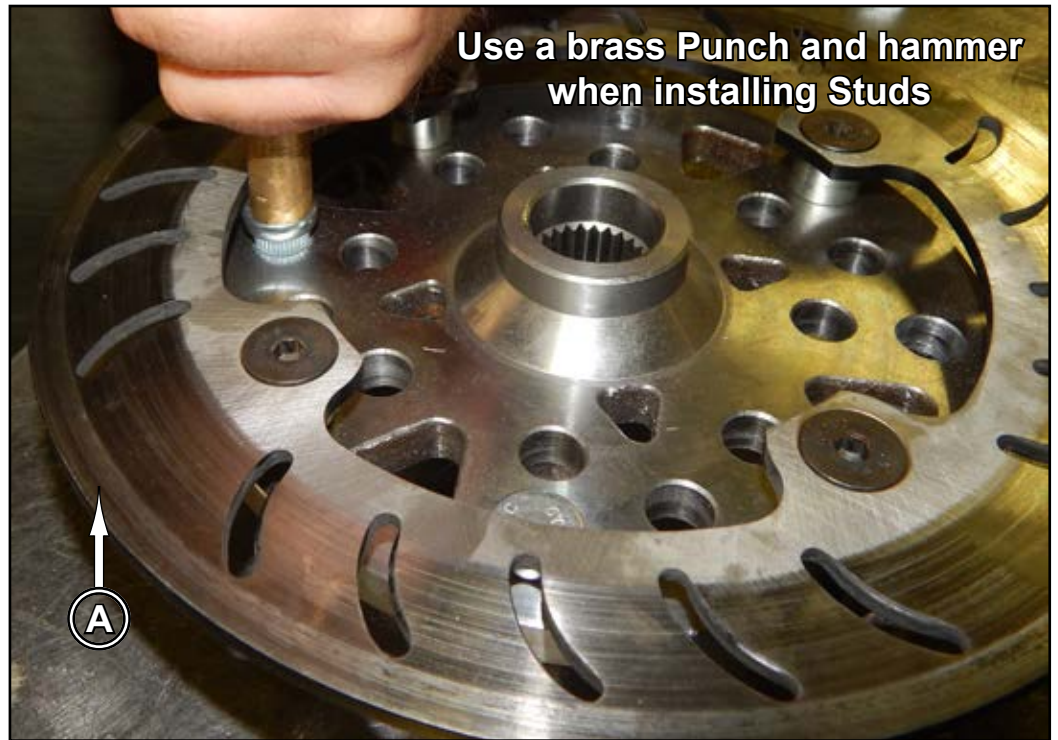
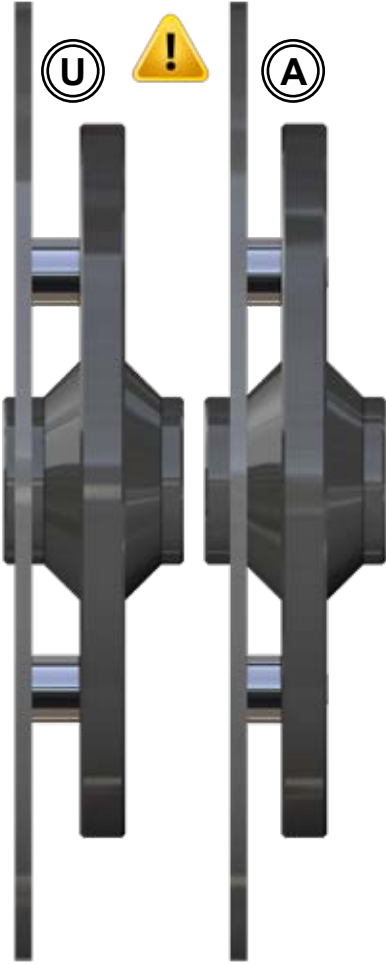

Wheel Hub Bolt Patterns

- A - - - -
- B - - - -
- C - - - -
- D - - - -

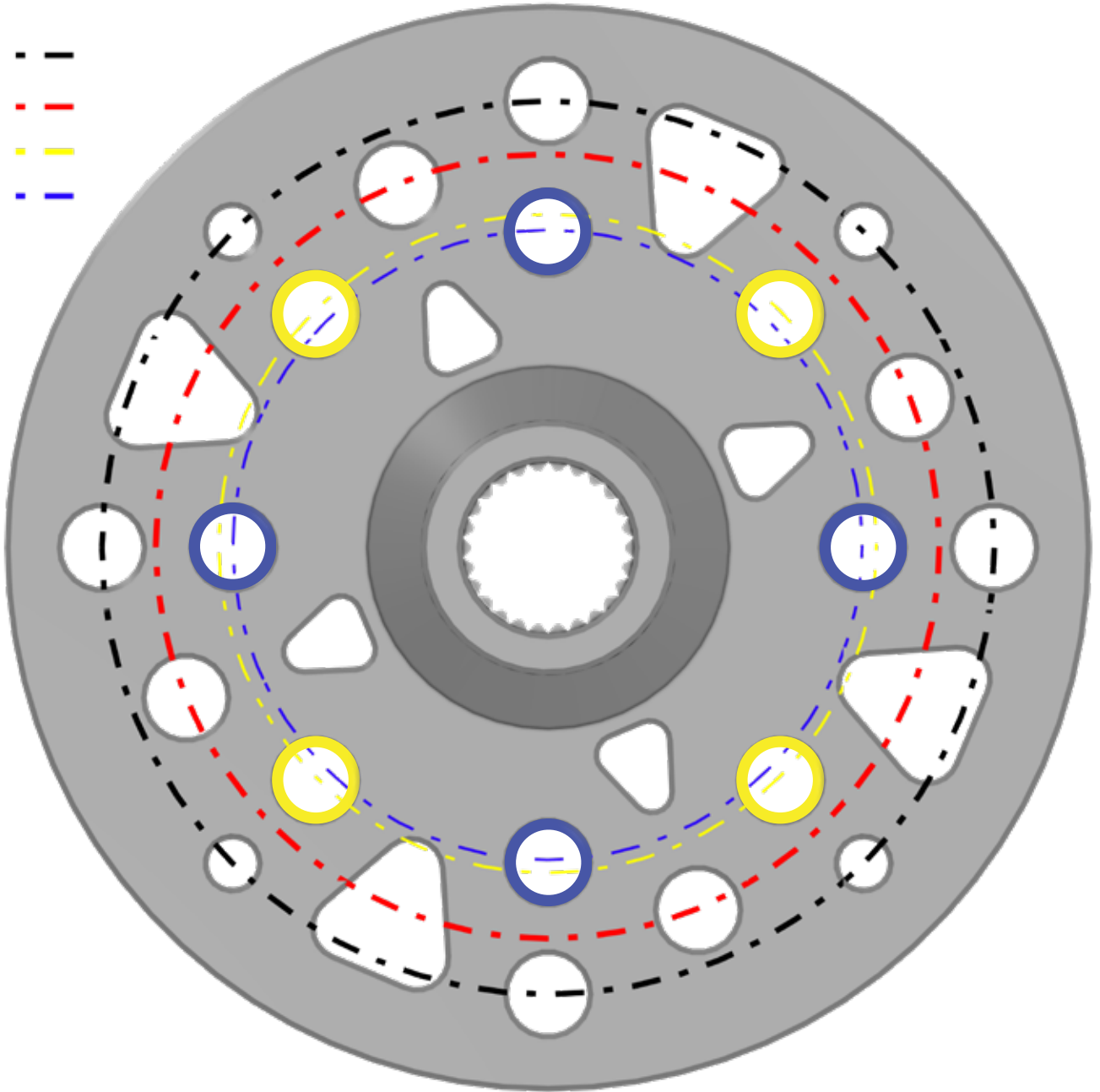

Pattern	Machine	Diameter
A	Polaris	156mm
B	Can-Am/Teryx4	137mm
C	Arctic Cat	115mm
D	Honda/Yamaha	110mm

Front: *do not tighten hardware completely unless noted.*
(driver side installation shown)

- Press stock Ball Joint into Left Front Plate (H) with hardware shown.

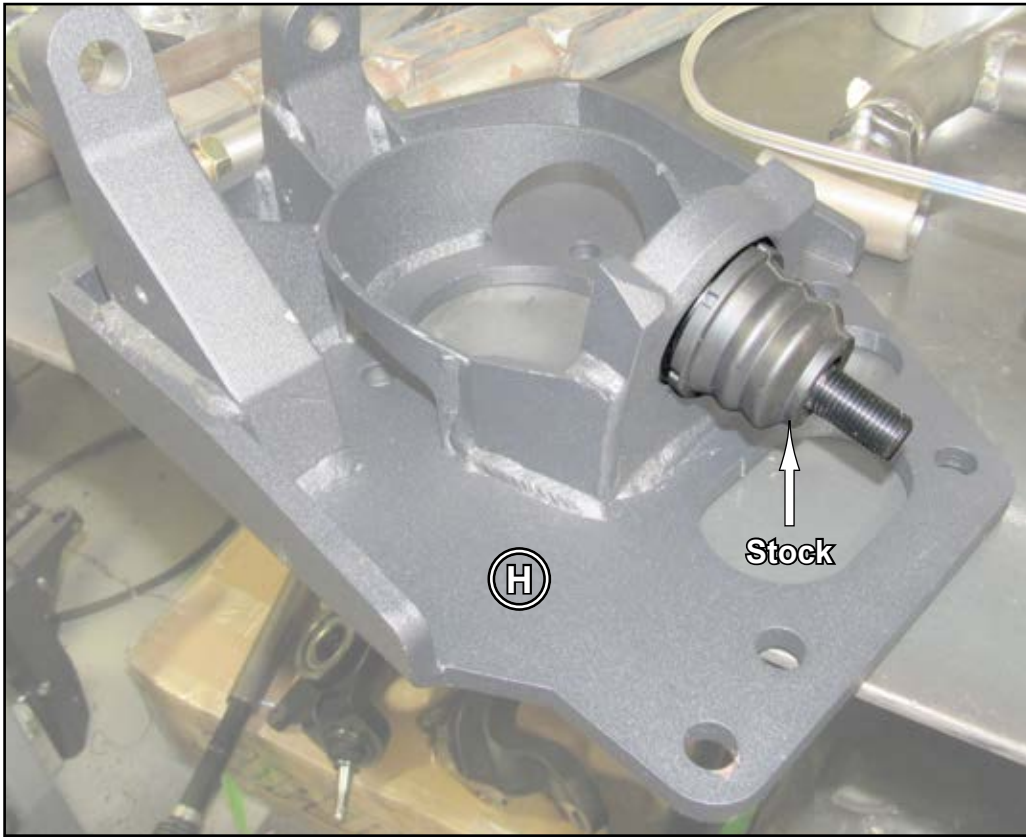

- Secure Left Front Plate (H) to A-Arms with stock hardware.

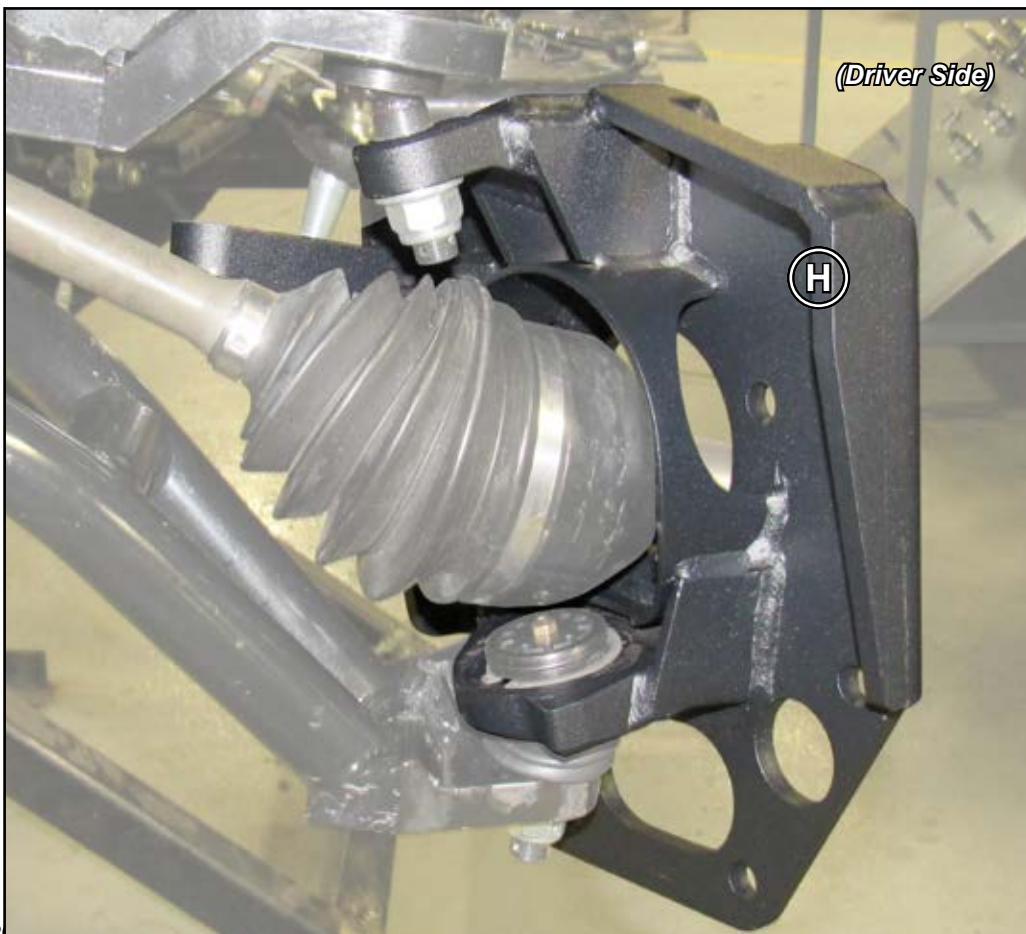

Front continued:

- Secure Left Gear Box (B) and Front Caliper Mounting Plate (G) to Left Front Plate (H) with hardware shown.
- Secure Axle with Recessed Nut - Front Left (P); use thread locker.

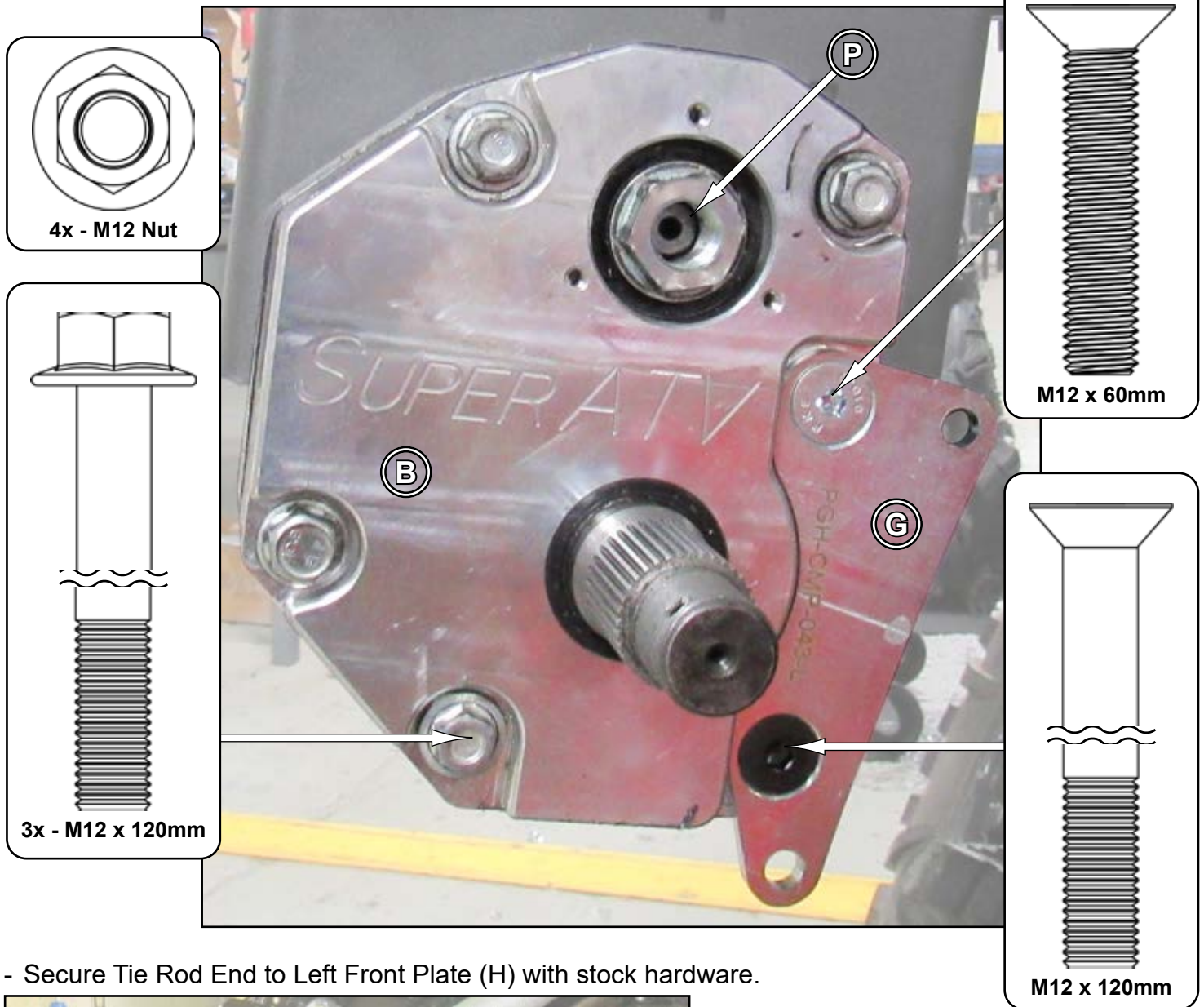

- Secure Tie Rod End to Left Front Plate (H) with stock hardware.

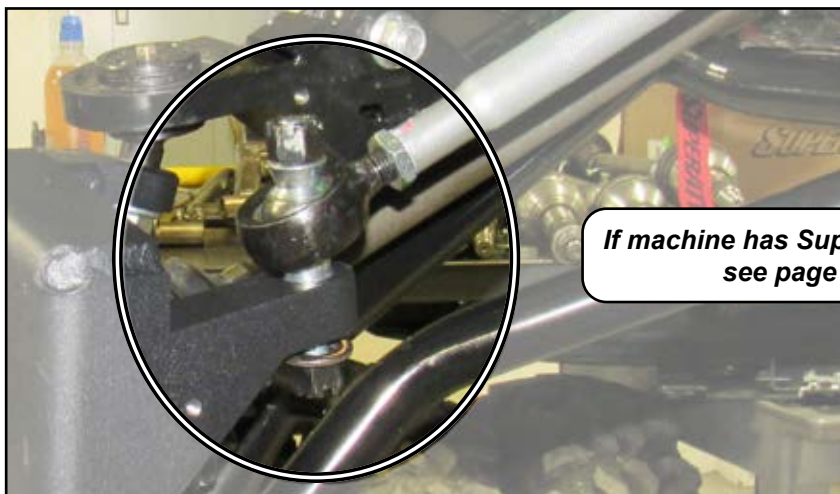

If machine has SuperATV Heavy Duty Tie Rod Ends see page 2 for correct hardware.

Tighten all hardware completely.

Front continued:

- Secure Gasket (D) and Cap (E) to Left Gear Box (B) with hardware shown.

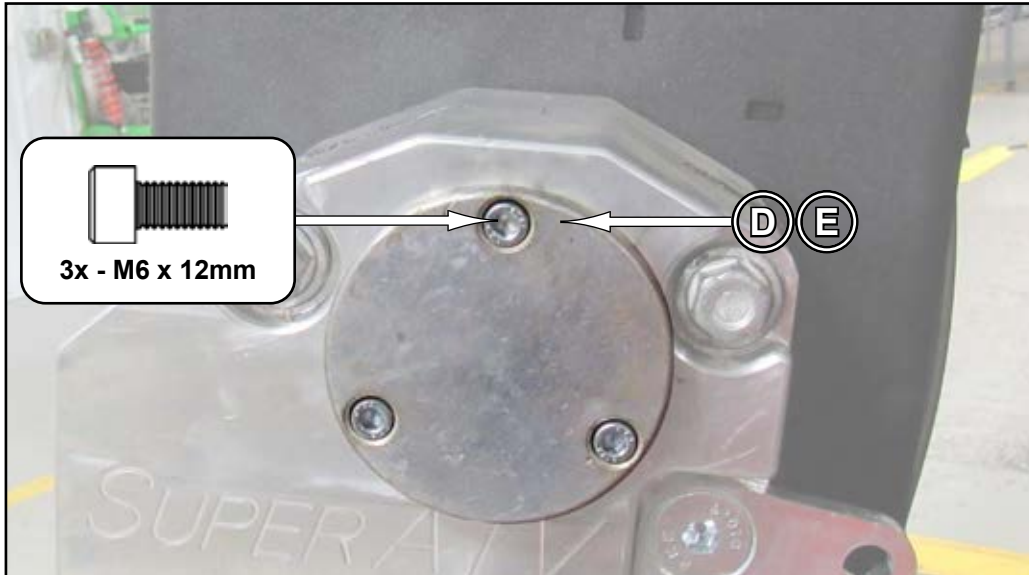

- Secure Front Rotor (A) to Gear Box Axle Shaft with hardware shown.

Torque to minimum 300 Ft/Lbs. Continue tightening until Cotter Pin can be installed.



Tighten all hardware completely and repeat steps for opposite side.

Front continued:

- Reinstall stock Calipers to Front Caliper Mounting Plate (G) with hardware shown.
- **Front Brake Calipers must be switched: passenger side to driver side. Bleeders must face up.**
- Install provided Front Brake Lines.
- Ensure that no binding occurs after Brake Lines have been installed and secured.

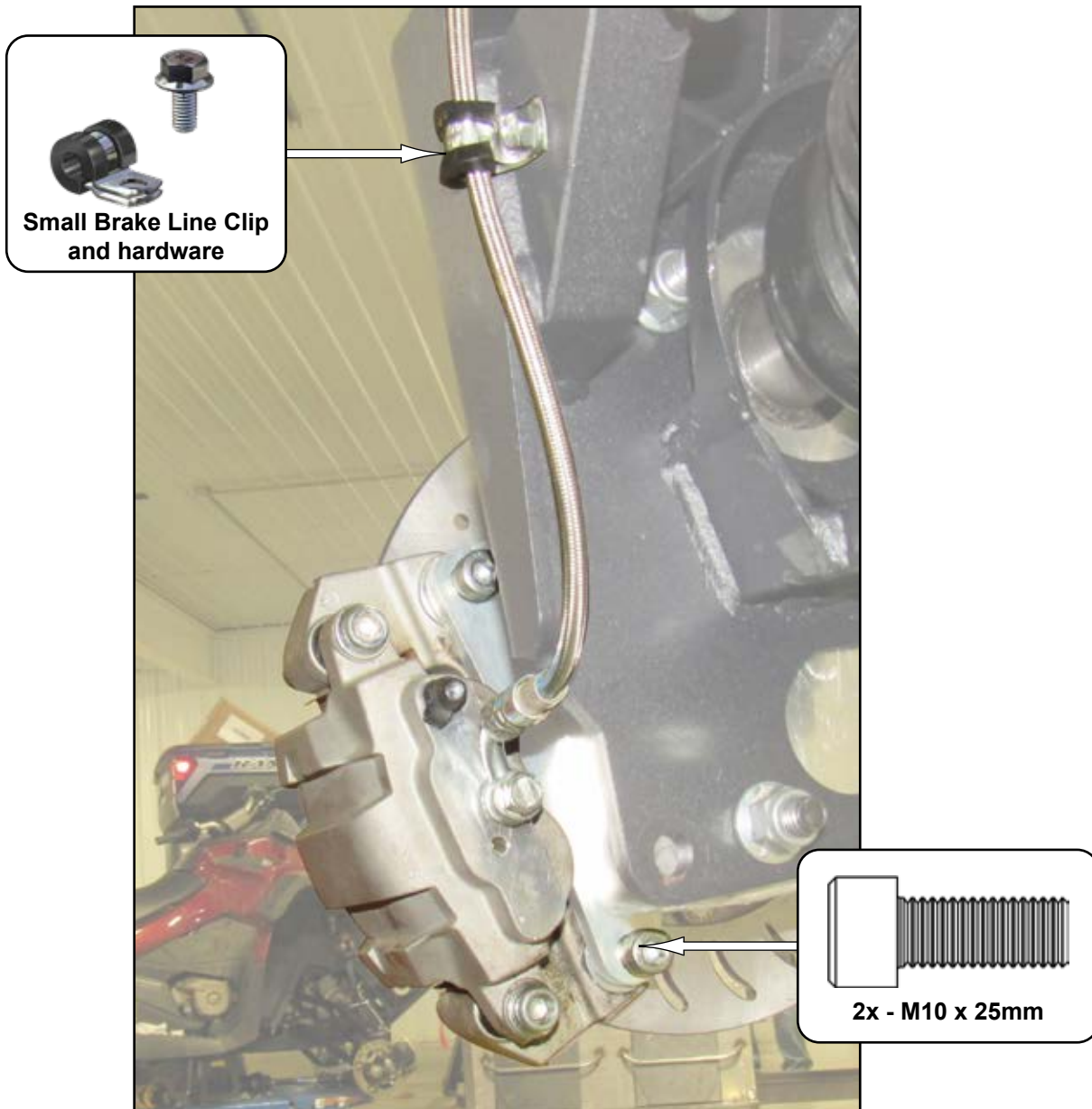

Rear: *do not tighten hardware completely unless noted.*
(driver side installation shown)

- Install stock Sleeve, O-Rings, Caps, and Bushings into Left Rear Plate (K).

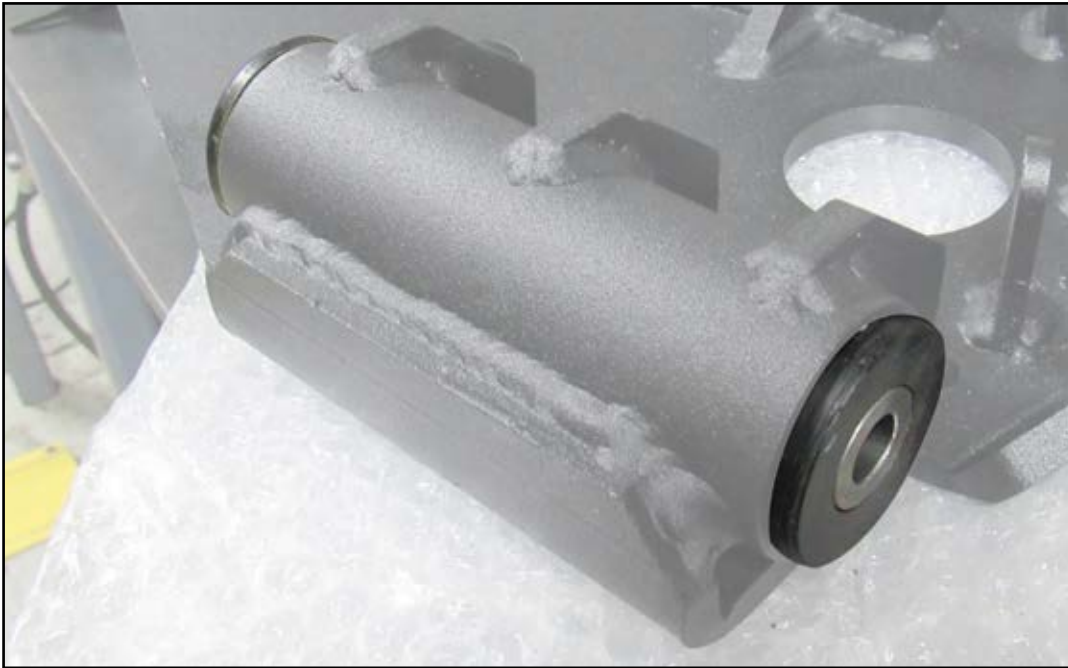

- Install Left Rear Plate (K) with stock hardware.



Rear continued:

- Secure Lower Radius Arm to Left Rear Plate (K) with hardware shown.

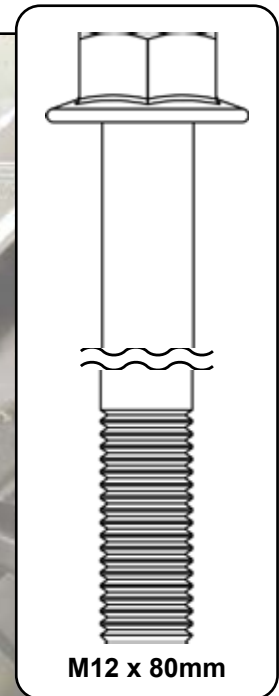
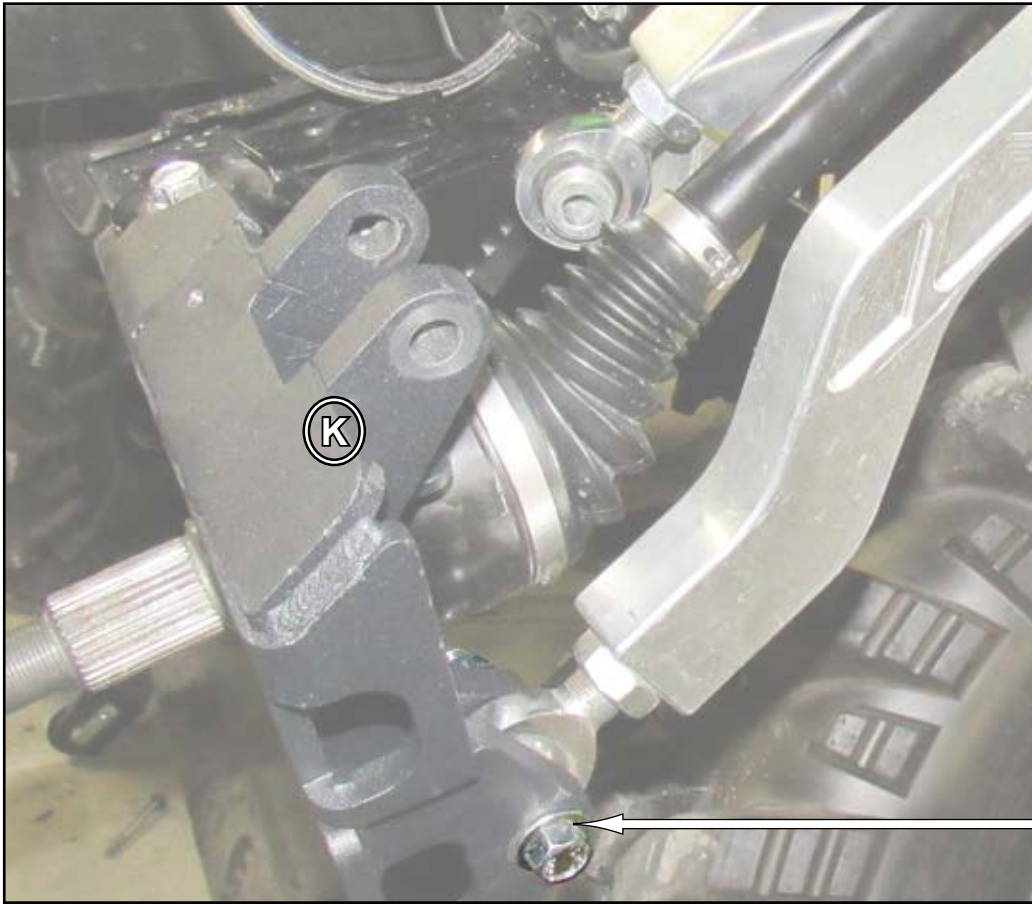

M12 x 80mm

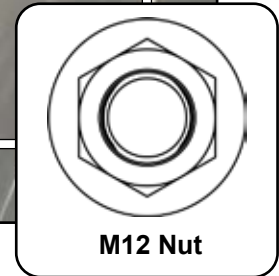

M12 Nut

- Secure Rear Brake Line Extension to Left Rear Plate (K) with hardware shown.

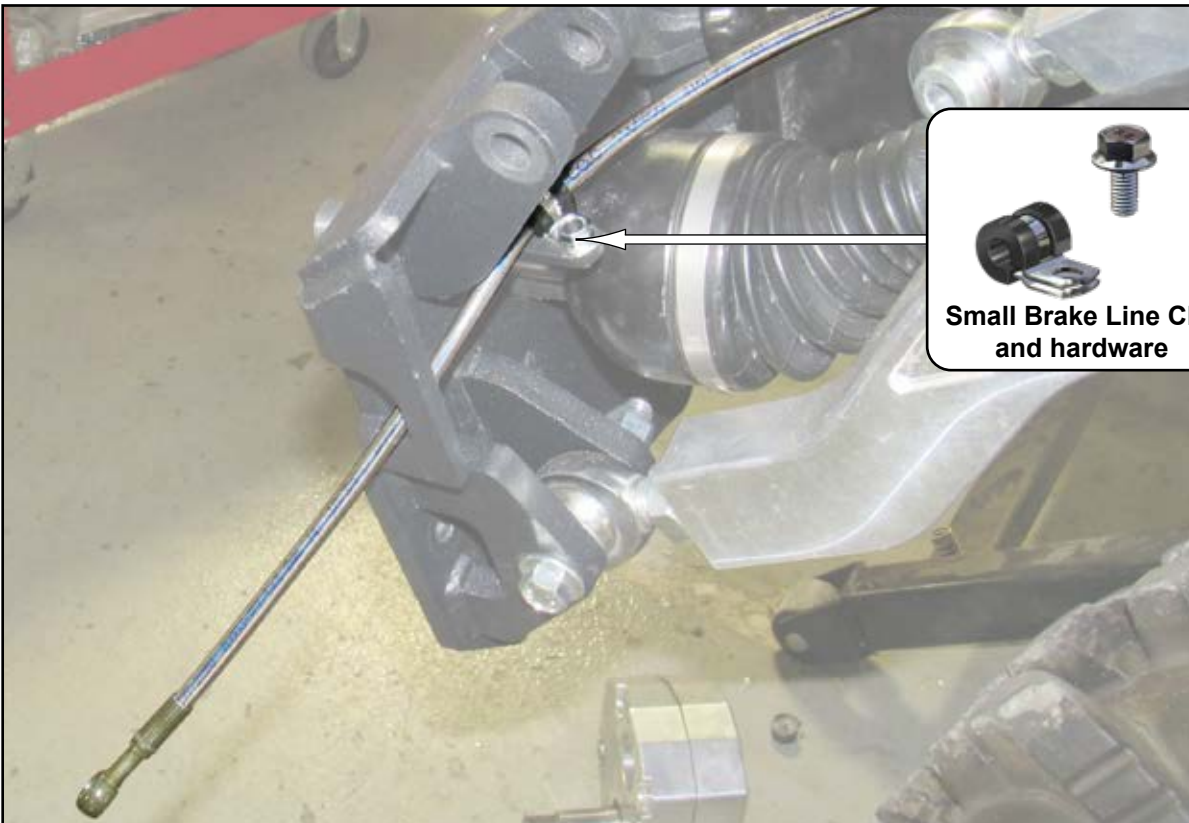

Small Brake Line Clip and hardware

Rear continued:

- Secure Upper Radius Arm to Left Rear Plate (K) with hardware shown.

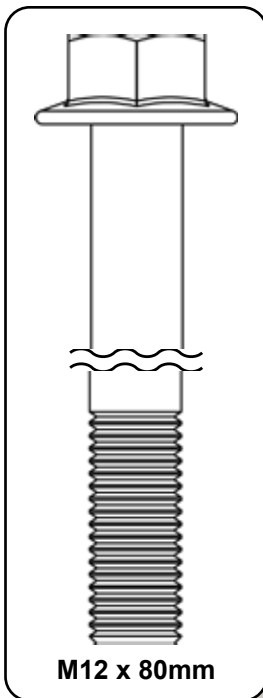

Rear continued:

- Secure Left Gear Box (B) and Rear Caliper Mounting Plate (P) to Left Rear Plate (K) with hardware shown.
- Secure stock Axle with Recessed Nut - Rear Left (M); use thread locker.

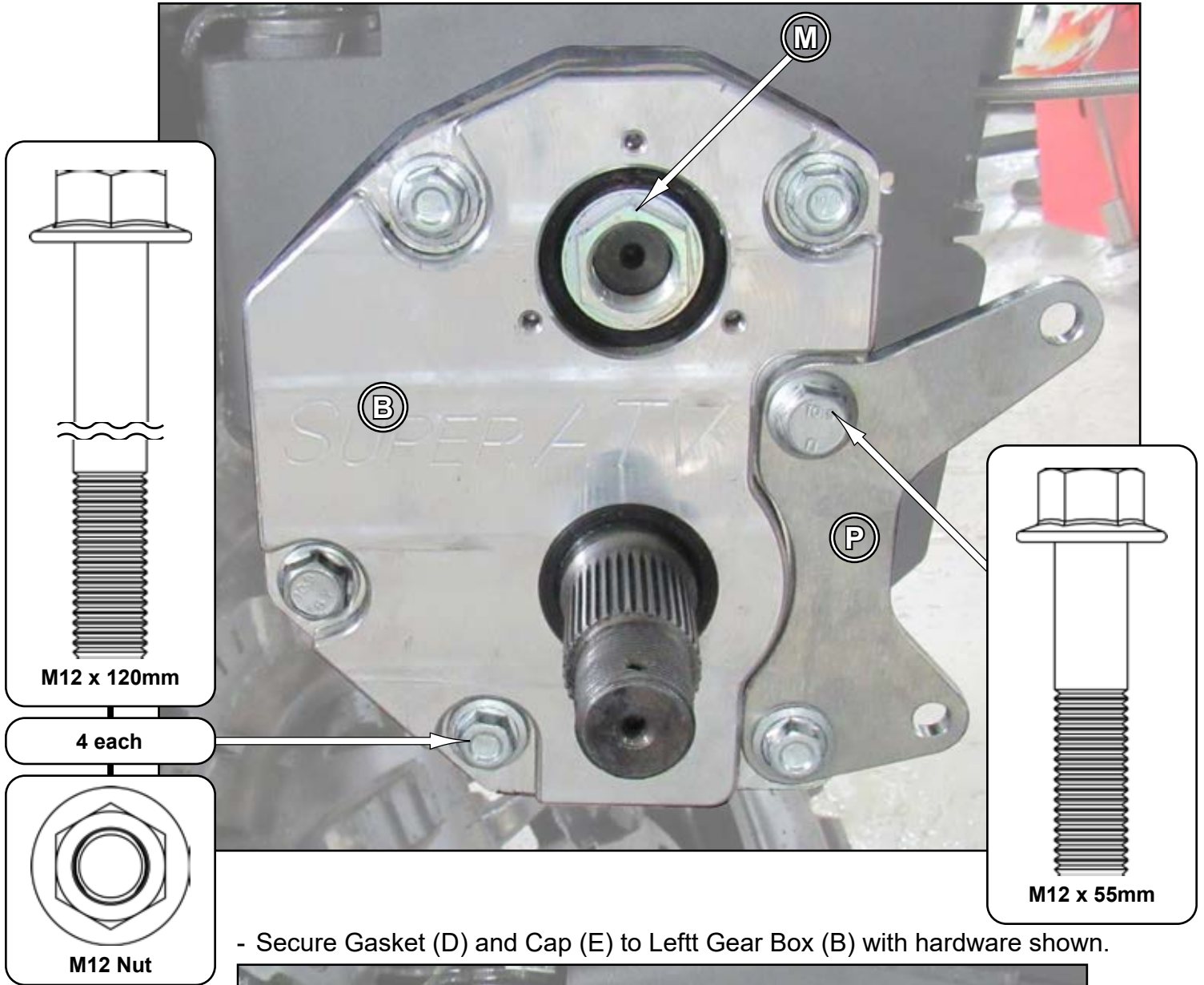

- Secure Gasket (D) and Cap (E) to Left Gear Box (B) with hardware shown.

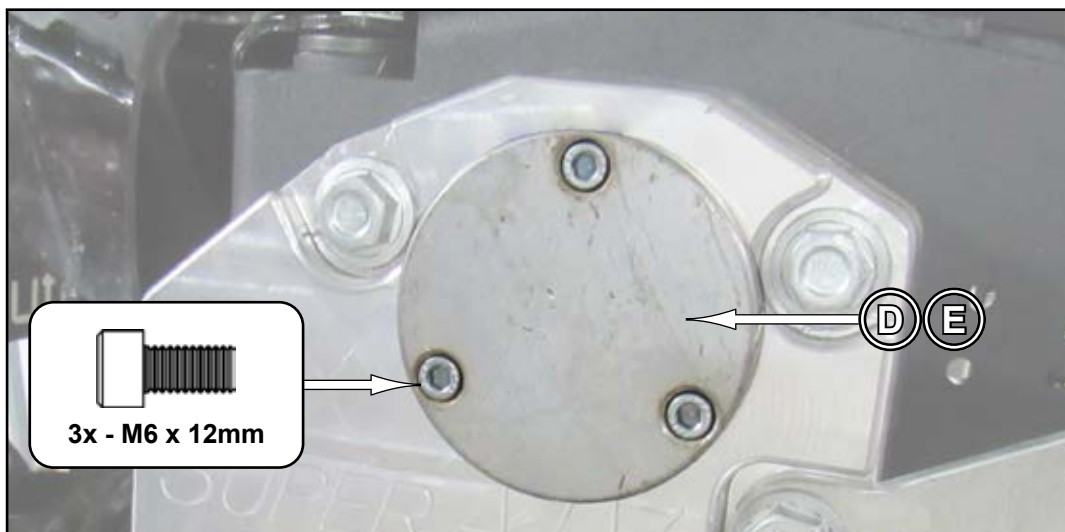

Rear continued:

- Secure Rear Rotor (U) to Gear Box Axle Shaft with hardware shown.

Torque to minimum 300 Ft/Lbs. Continue tightening until Cotter Pin can be installed.

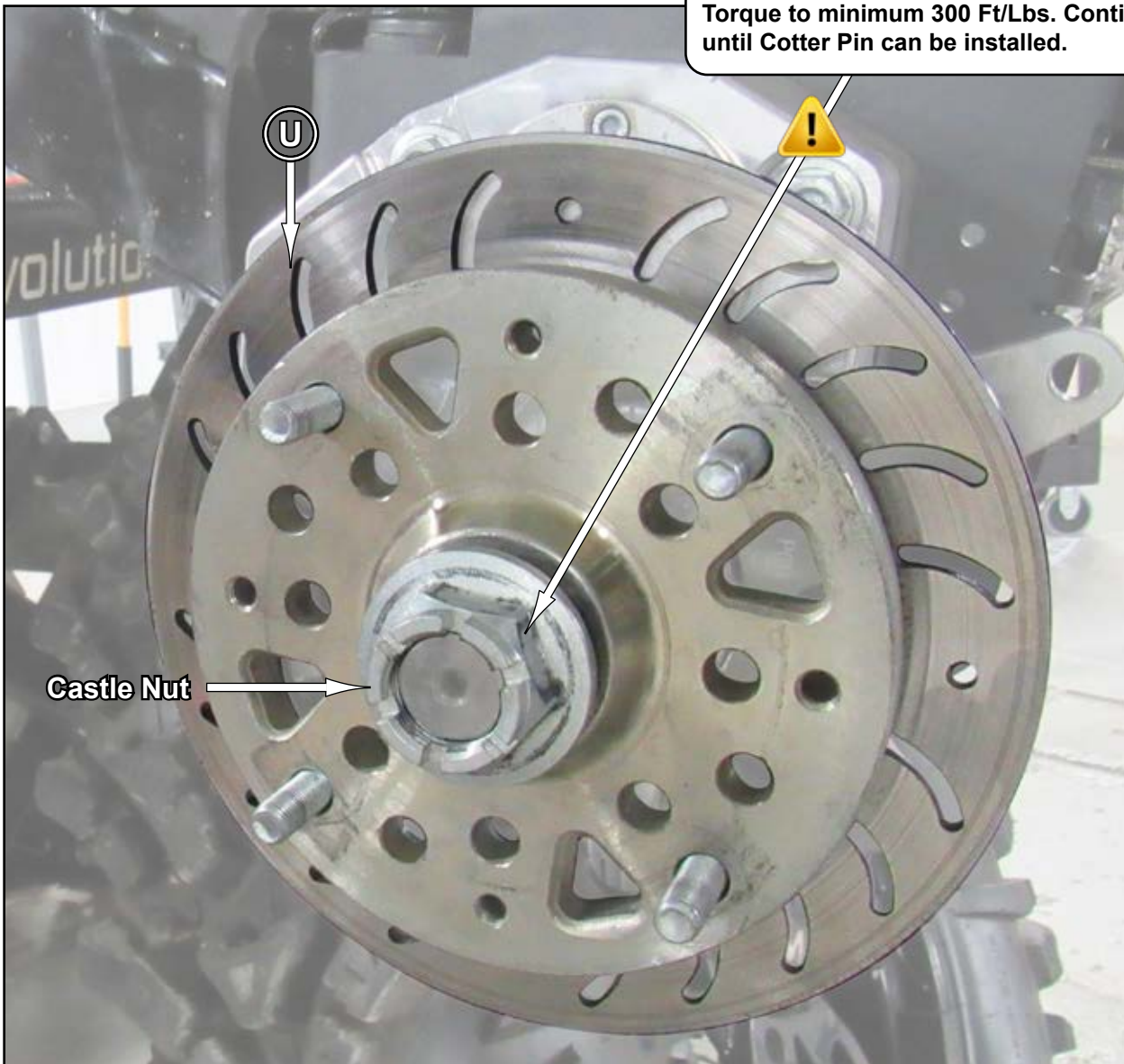

Tighten all hardware completely.

Rear continued:

- Install Left Brake Cable Bracket (S) to Caliper with hardware shown.

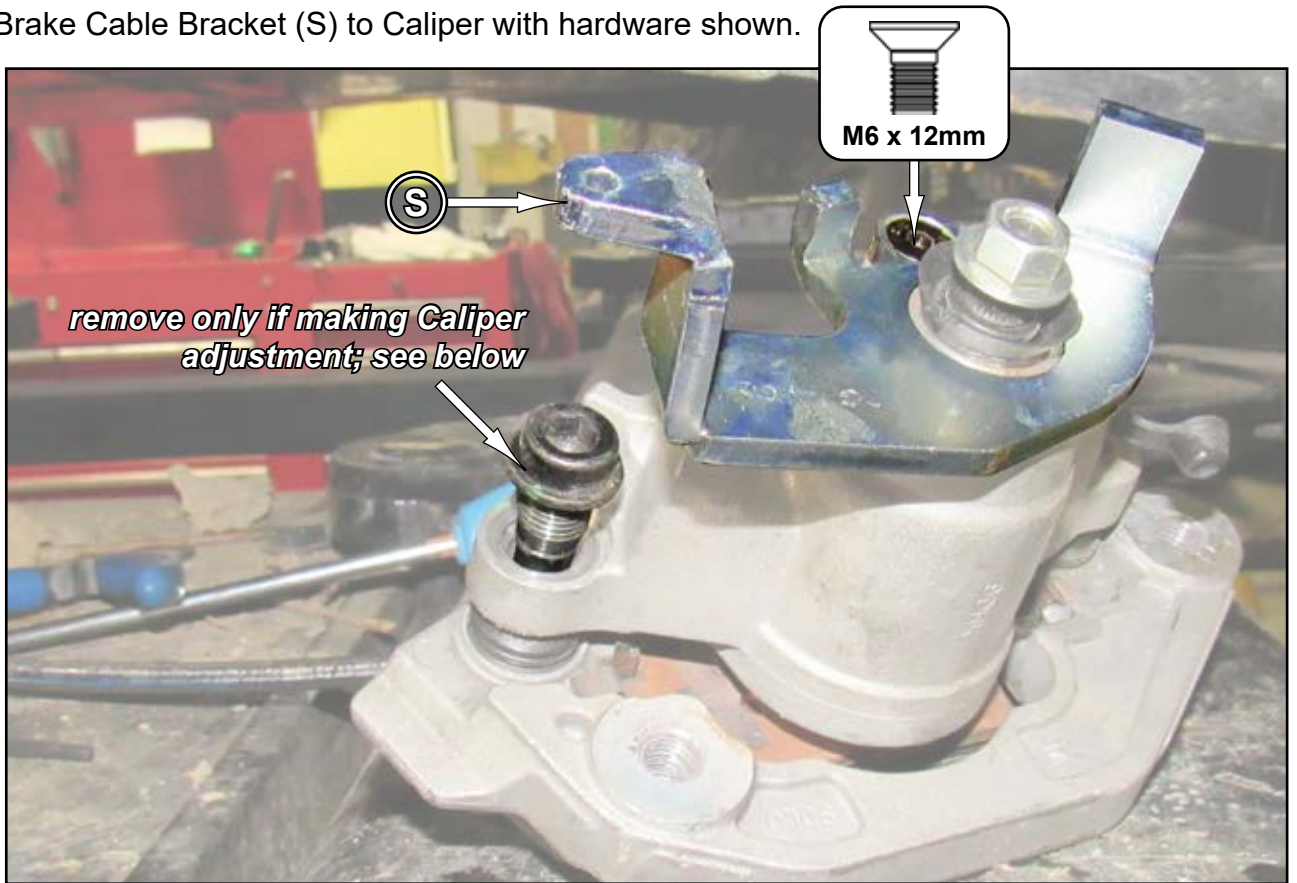

Caliper adjustment:



Rear continued:

- Install Caliper with hardware shown.
- Connect Rear Brake Line Extension to Caliper.

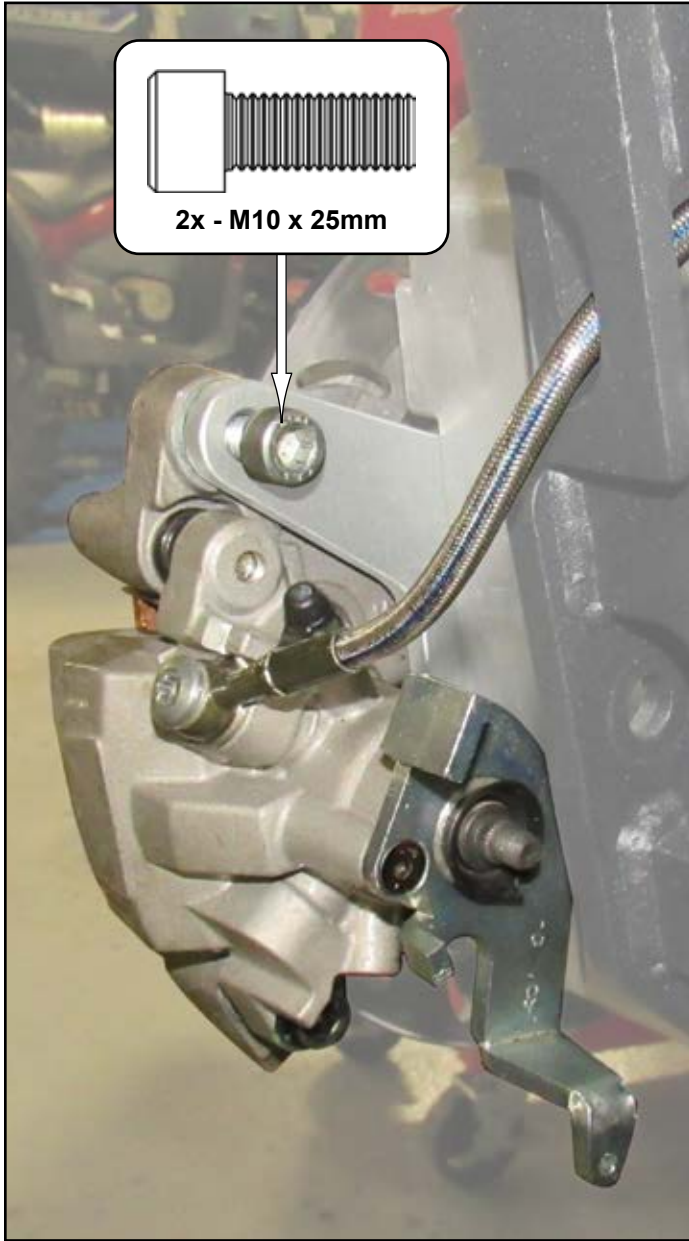

- Install Left Parking Brake Bracket (Q) to Left Rear Plate (K) with hardware shown.

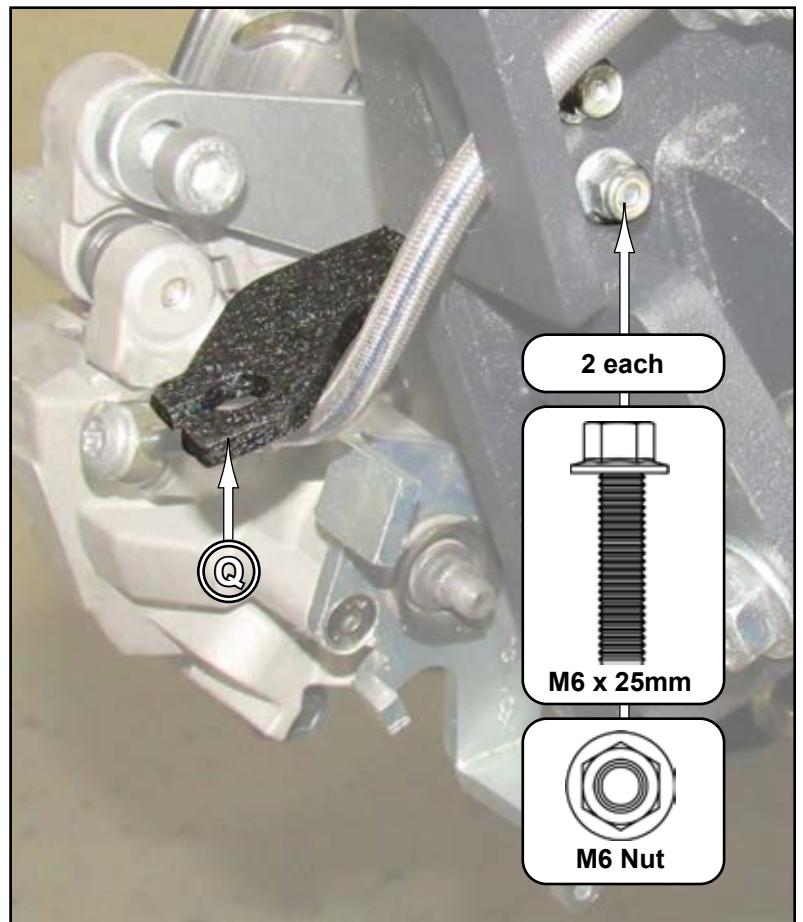

Rear continued:

- Secure Parking Brake Cable to Left Parking Brake Bracket (Q).



- Connect Return Spring.

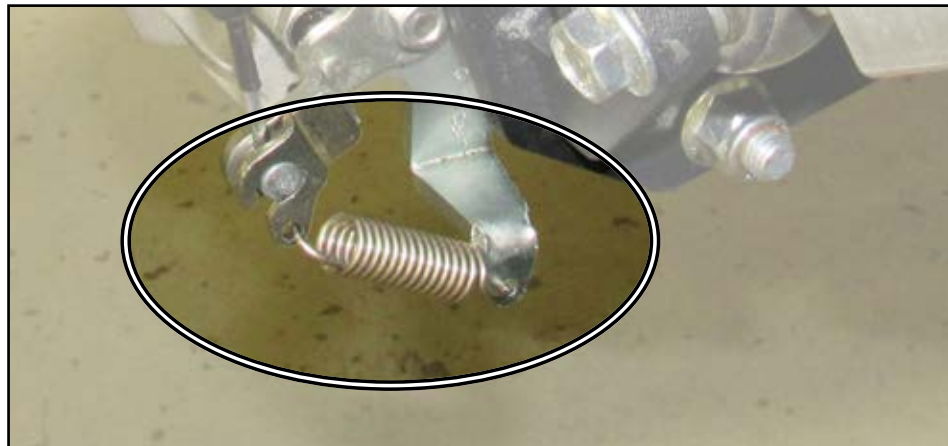

Tighten all hardware completely and repeat steps for opposite side.

Rear continued:

- Remove Shock from Arm and secure Brake Lines with stock components.
- Reinstall Shock and Cover.



- Secure Brake Lines and Cables with components shown.

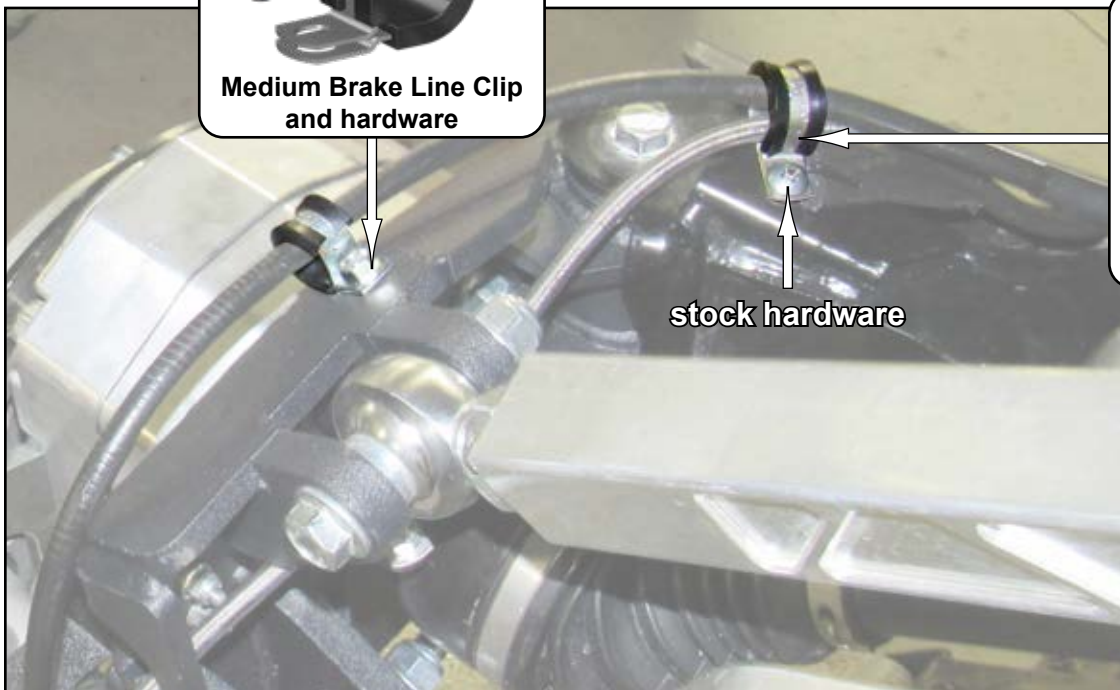

Rear continued:

- Bleed Brake system.
- Refer to service manual and Adjust Parking Brake Cables; tighten hardware completely.

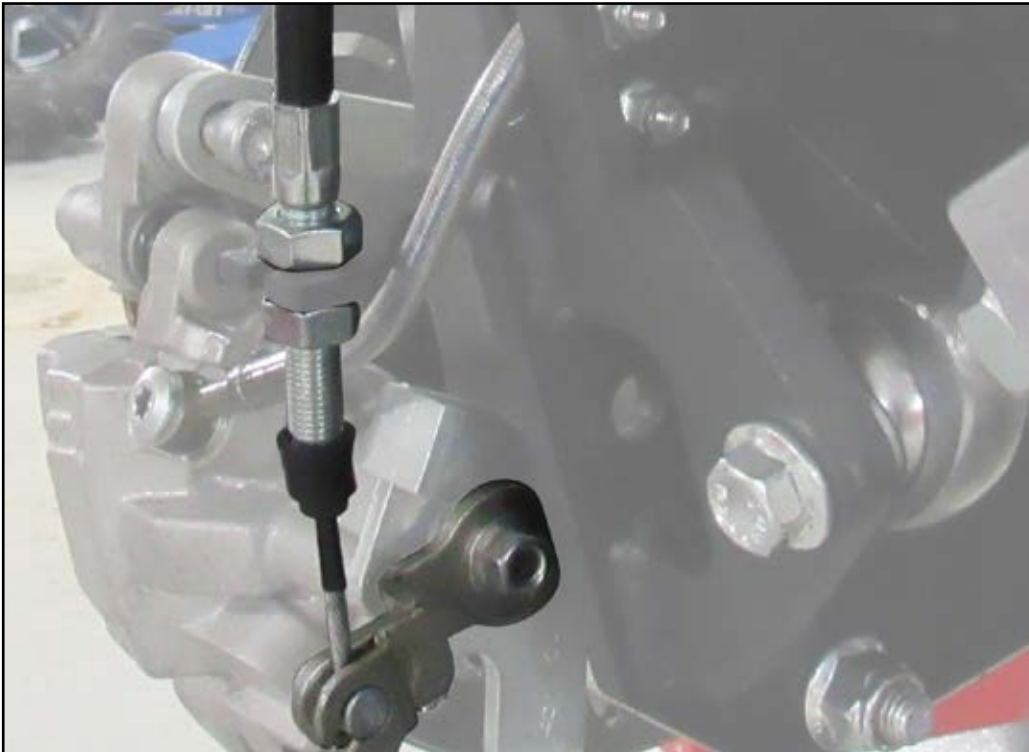



- In certain instances, interference may occur between Caliper and Rotor. Install provided CMP Shim between CMP and Gear Box.

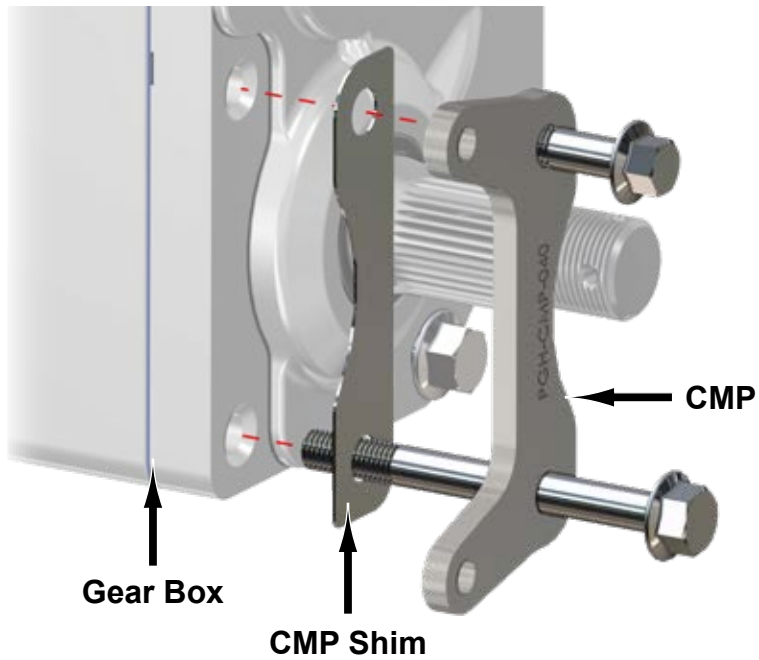

- Attach a hose to a funnel and fill each Gear Box with SuperATV Portal Blood.
- Fill up to fill hole.
- Install Drain Plug.

