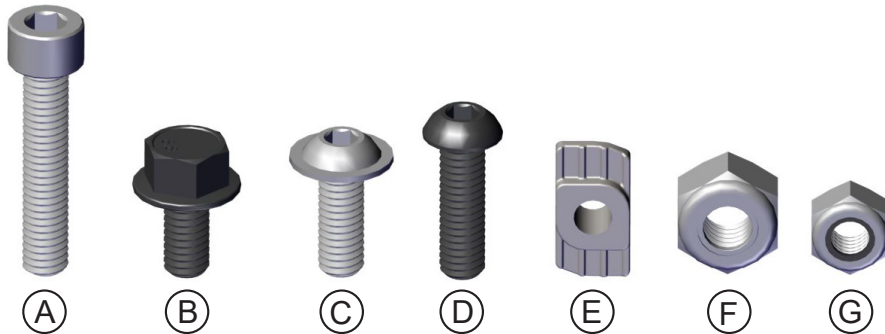
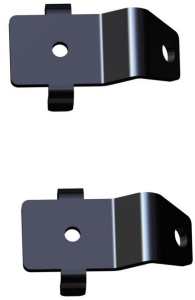


**INSTALLATION INSTRUCTIONS**  
**Flip Rear Windshield: IN-FRWS-P-XPDADV**

**Bulb Seal**

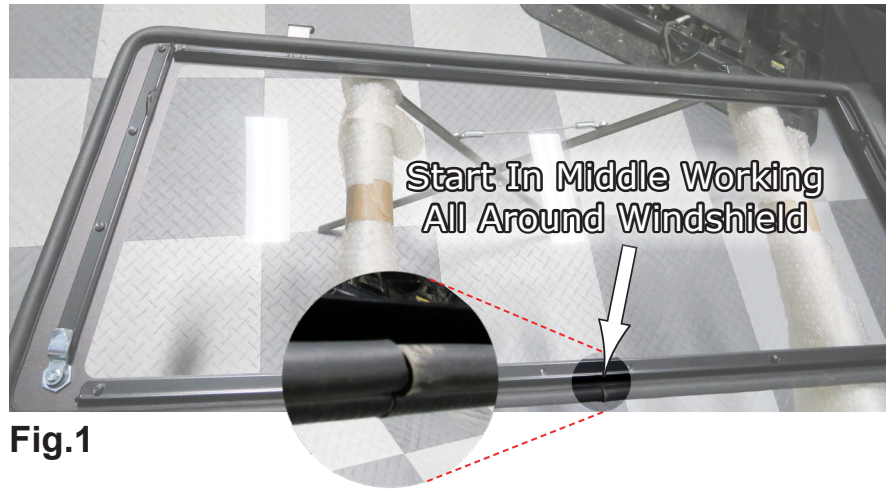


**Rear Windshield**



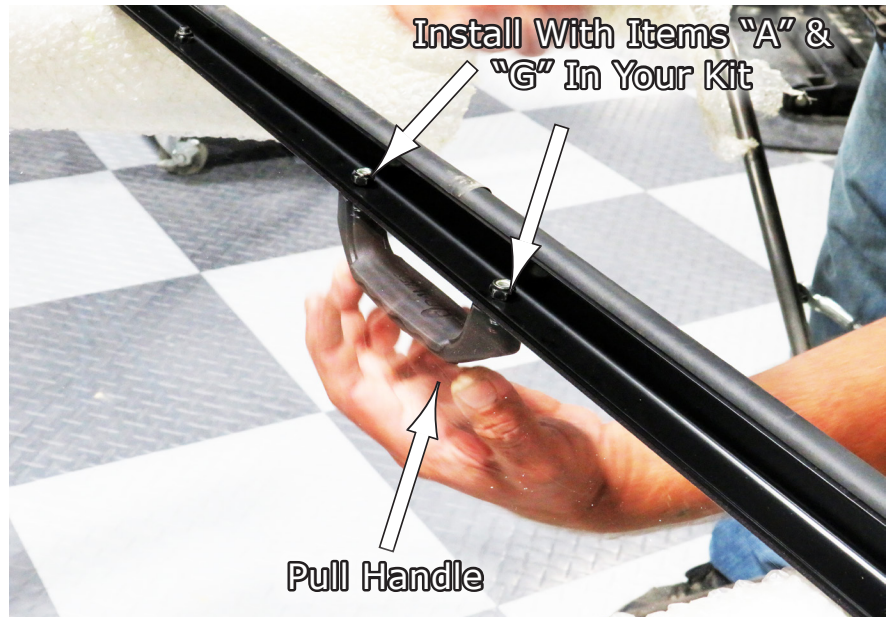
Item	Description	Qty	Item	Description	Qty
A	M6X30 Socket FT	2	E	M6 Tapped T-Nut	2
B	M6x12 Hex Flanged FT	2	F	M8 Nylock Nut	4
C	M6x16 Flanged FT Button Head	4	G	M6 Nylock Nut	6
D	M6X20 FT Button Head	4			

1. First, you need to install the Bulb Seal all around the outer perimeter of the windshield. Start in the middle of the top or bottom working your way all around to meet the starting edge. Cut off any excess seal. See **Fig.1**.



**Fig.1**

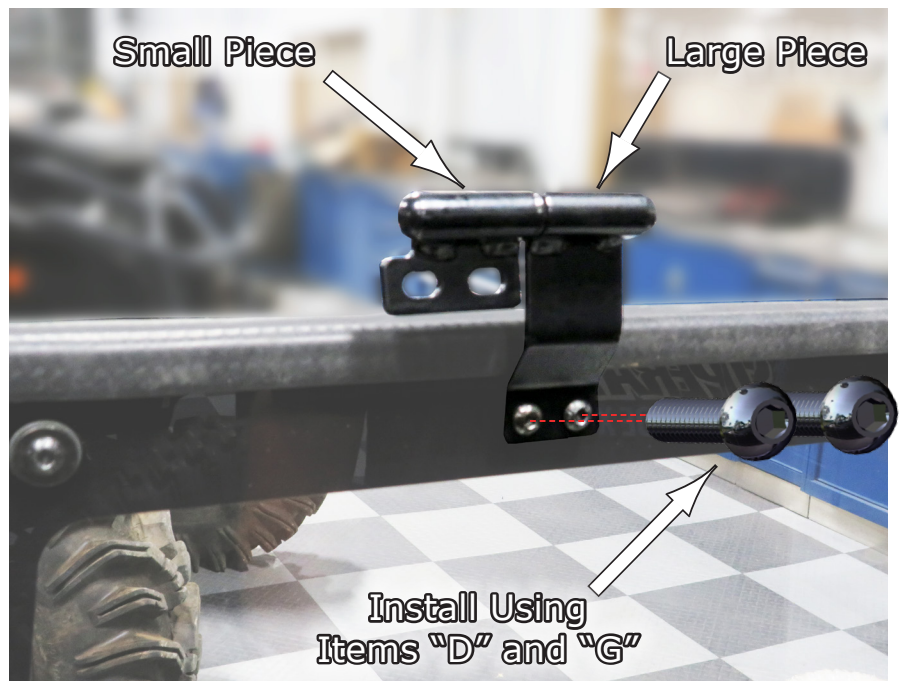
2. Next, you need to install the Pull Handle from your kit onto the windshield. Do this by using items "A" (M6x30 Bolt) & "G" (M6 Nylock Nut) from your kit, and secure. See **Fig.2**.



**Fig.2**

3. Now install the hinges to the windshield. These are set up in pairs. You can reference how the pairs go together as shown on the cover of these instructions. The Upper Left-hand corner of the windshield is shown in **Fig.3**. The right side is just mirrored of the one shown in **Fig.3**.

Install the large piece to the windshield by using the M6x20 - **Item "D"** and M6 Nylock Nut - **Item "G"**. Repeat the same for the right side. Go ahead and insert the smaller piece into the larger piece also shown in **Fig.3**.



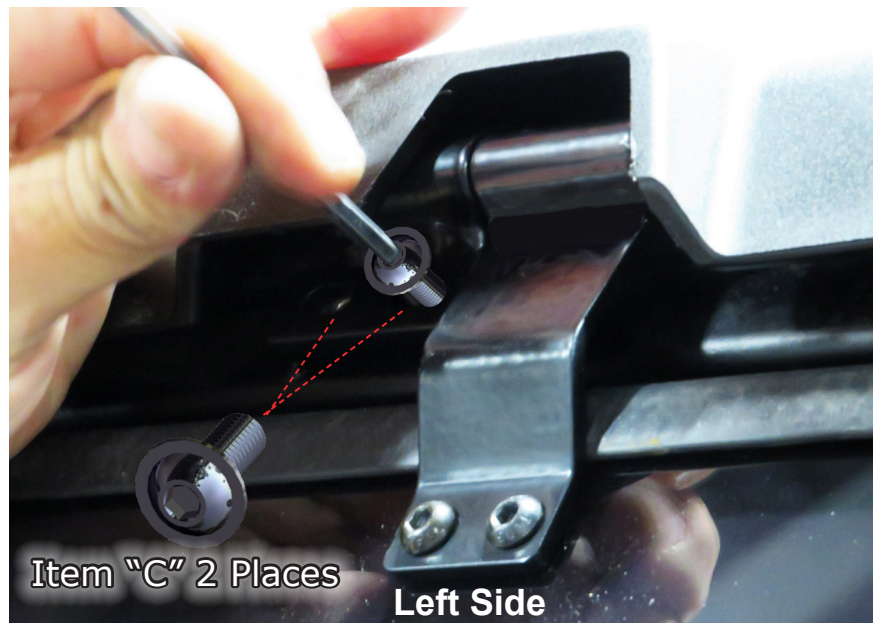
**Fig.3**

4. Now put the windshield in place so you can attach it to the vehicle, see **Fig.4**. You will be bolting the smaller piece of the hinges onto the vehicle in the next steps.



**Fig.4**

5. Install the hinge to the vehicle by using the **M6x16 Flanged Button Head, Item "C"** in from your kit in two places and secure as shown in **Fig.5**. Repeat for the Right side.



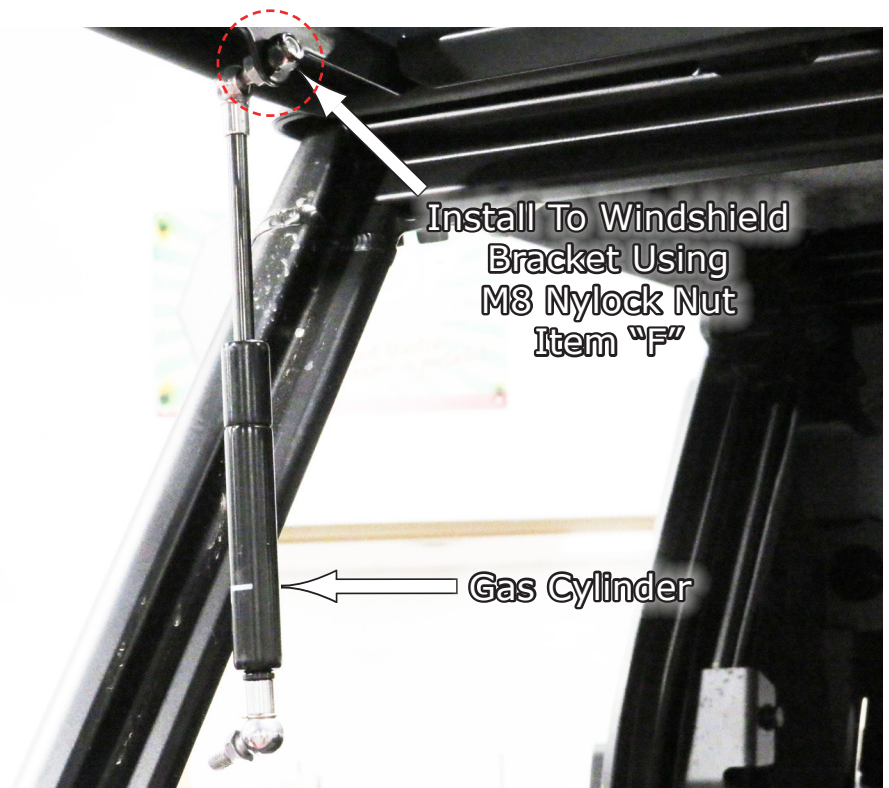
**Fig.5**

6. **Fig.6** shows the windshield installed up to this point. Next we will install the gas cylinder to the windshield and brackets.



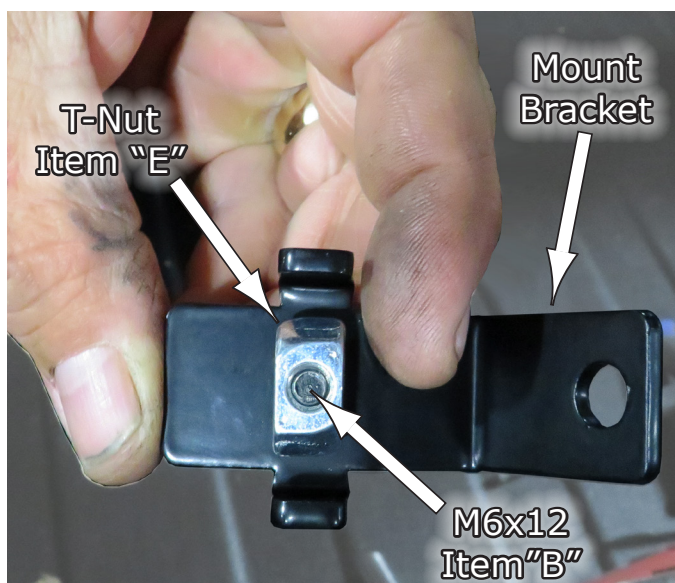
**Fig.6**

7. Next, raise the windshield and install the top end of the gas cylinder to the mounting bracket on the inside of the windshield using the M8 Nylock Nut, **Item "F"** provided in your kit. See **Fig.7**.

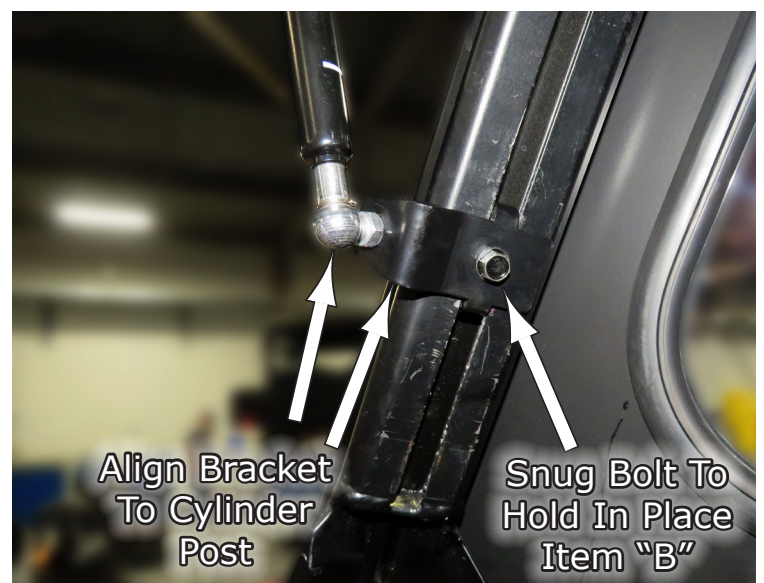


**Fig.7**

8. Now find the **Strut Brackets**, the **Tapped T-Nut Item "E"** and the **M6x12 Flanged Hex Bolt Item "B"** in your kit. Assemble the T-Nut to the Mounting Bracket with **Item "B"** as shown in **Fig.8a**. Then insert into the frame channel of the vehicle as shown in **Fig.8b**, and adjust the height of the bracket so that the lower threaded post of the gas cylinder mates up with the hole in the bracket. Insert the post thru the hole. Then snug the bolt but don't fully tighten it yet until the windshield has had a final adjustment. Then tighten down. See **Fig.8b**.



**Fig.8a**



**Fig.8b**

9. Next, install the gas cylinder to the bracket using the M8 Nylock Nut, Item "F" provided in your kit, and secure. Repeat for opposite side.



After both cylinders are hooked up, go back and make a final adjustment making sure the windshield opens and closes properly, the latch is working and all is sealing where needed. Once you have it set where you want it, then tighten down all hardware securely to keep it in place.

**Liability Statement**

SuperATV's® products are designed to best fit user's ATV/UTV under stock conditions. Adding, modifying, or fabricating any factory or aftermarket parts will void any warranty provided by SuperATV® and is not recommended. SuperATV's® products could interfere with other aftermarket accessories. If user has aftermarket products on machine, contact SuperATV® to verify that they will work together.

Although SuperATV® has thousands of satisfied customers, user should be aware that installing lift kits, long travel, or suspension kits, tires, etc. will change the ride of machine and may increase maintenance and part wear. Operating any off-road machine while, or after, consuming alcohol and/or drugs increases risk of bodily harm or death. No warranty or representation is made as to this product's ability to protect user from severe injury or death. SuperATV® urges operators and occupants to wear a helmet and appropriate riding gear at all times.

By purchasing and installing SuperATV® products, user agrees that should damages occur, SuperATV® will not be held responsible for loss of time, use, labor fees, replacement parts, or freight charges. SuperATV®, nor any 3rd party, will not be held responsible for any direct, indirect, incidental, special, or consequential damages that result from any product purchased from SuperATV®. The total liability of seller to user for all damages, losses, and causes of action, if any, shall not exceed the total purchase price paid for the product that gave rise to the claim.

SuperATV® will warranty only parts provided by SuperATV®. Any damage or problems with OEM housings, bearings, seals, or other manufacturers' products will not be covered by SuperATV®. SuperATV® parts and products are not warranted if item was not installed properly, misused, or modified.

Installing, adding, modifying, or fabricating any factory or aftermarket product to your ATV/UTV may violate certain local, state, and federal laws. Be advised that laws vary depending on town, city, county, state, etc. Use of certain products on public streets, roads, or highways may be in violation law. The Buyer is solely and exclusively legally and personally responsible for any violation of the law by the installation or use of the product. You must abide by all local, state, and federal laws, including but not limited to vehicle safety, traffic laws, and ordinances. It is your responsibility to know the laws and how they apply to you.

The Buyer is responsible to fully understand the capability and limitations of his/her vehicle according to manufacturer specifications, warnings and instructions and agrees to hold SuperATV® harmless from any damage resulting from failure to adhere to such specifications, warnings and/ or instructions. The Buyer is also responsible to obey all applicable federal, state, and local laws and ordinances when operating his/her vehicle while using this product, and the Buyer agrees to hold SuperATV® harmless from any violation thereof.

If you have any problems/questions on this kit, contact us by email  
[Superatv.com.](mailto:sales@superatv.com)

**Need help with your installation?**



[sales@superatv.com](mailto:sales@superatv.com)



[www.superatv.com](http://www.superatv.com)



1-855-743-3427



8:00am - 9:00pm EST M-Th  
 8:00am - 7:00pm EST Friday  
 9:00am - 2:00pm EST Saturday

*Thank You  
 For Choosing*



**Like SuperATV on Facebook to keep up to date on new products!**