

**INSTALLATION INSTRUCTIONS**  
**Plug and Play Turn Signal Kit:**  
 for multiple Polaris Ranger<sup>®</sup> 1000 models

- Do not discard packaging until product has been successfully installed.
- Components may be installed in locations other than where shown. Always verify wire harness length.
- While routing, follow factory wiring when possible.
- Use provided dielectric grease on all connections.
- Always consult labels on Harnesses when making connections.
- Avoid rotating or hot components when securing.
- Before drilling any holes, check behind area to be drilled for any interference.

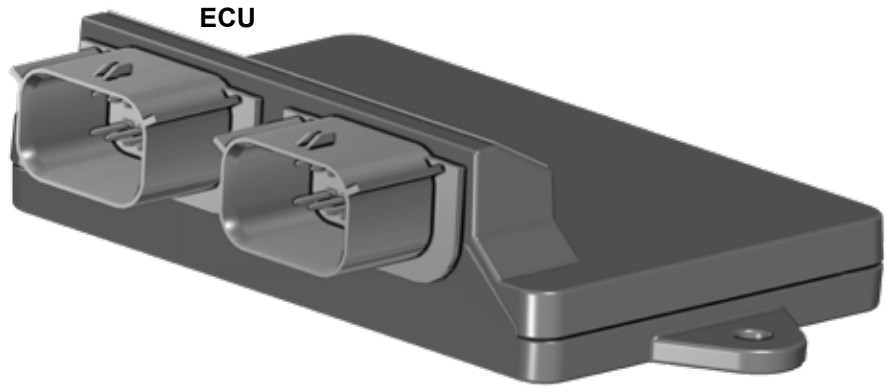

Horn Kit



ECU



Turn Signal Switch



Hazard and Horn Switch



Wire Ties

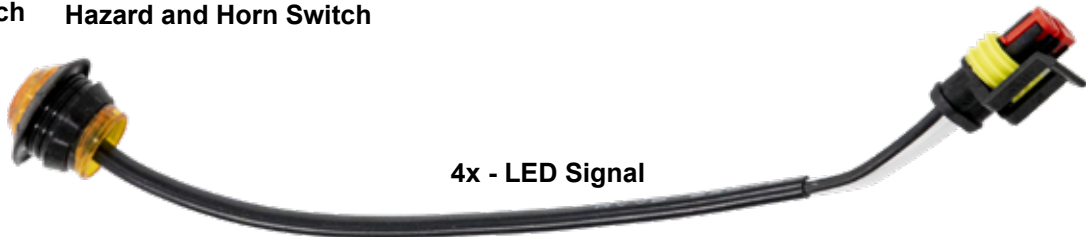

4x - LED Signal

**Need help with your installation?**

 [sales@superatv.com](mailto:sales@superatv.com)
 [www.superatv.com](http://www.superatv.com)

 1-855-743-3427
  8:00am - 8:00pm EST M-Th  
 8:00am - 7:00pm EST Friday  
 9:00am - 2:00pm EST Saturday

Read instructions and view illustrations before beginning.

Thank You  
 For Choosing  
**SUPERATV**.COM<sup>®</sup>

- Remove Seats, Storage Box, and Drive Shaft Cover.



- Crew® models will also remove Rear Seats, Storage Boxes, Rear Fenders, Rear Floor.



- Use dielectric grease on all connections.
- Always consult labels on Harnesses when making connections.

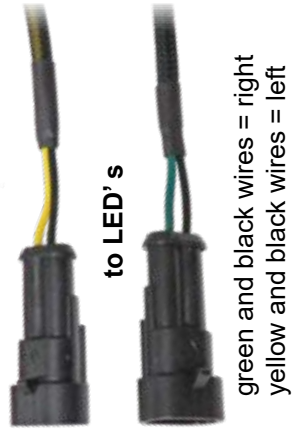
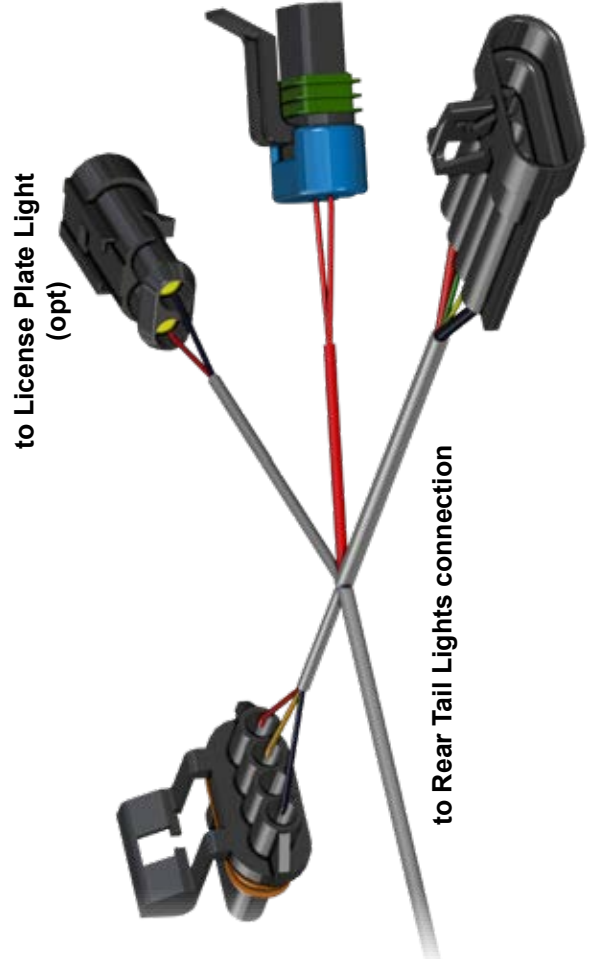
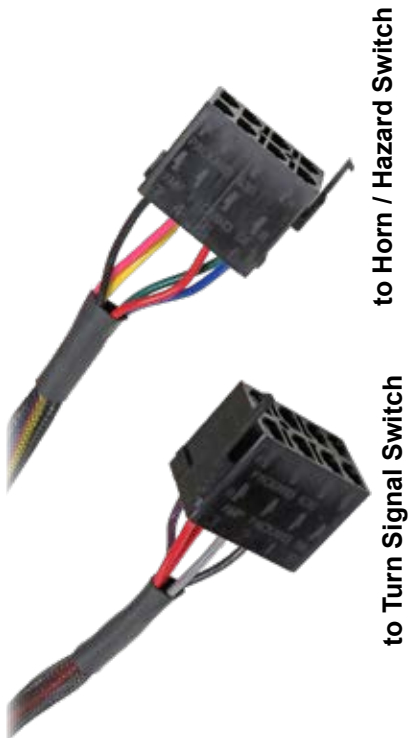

## Horn:

- User may install Horn in location different than shown.
- Illustration is SuperATV's choice.



- Connect Harness to Horn.
- Secure all Wires as needed.

- Secure ECU to Firewall with hardware shown.
- Connect Harness.

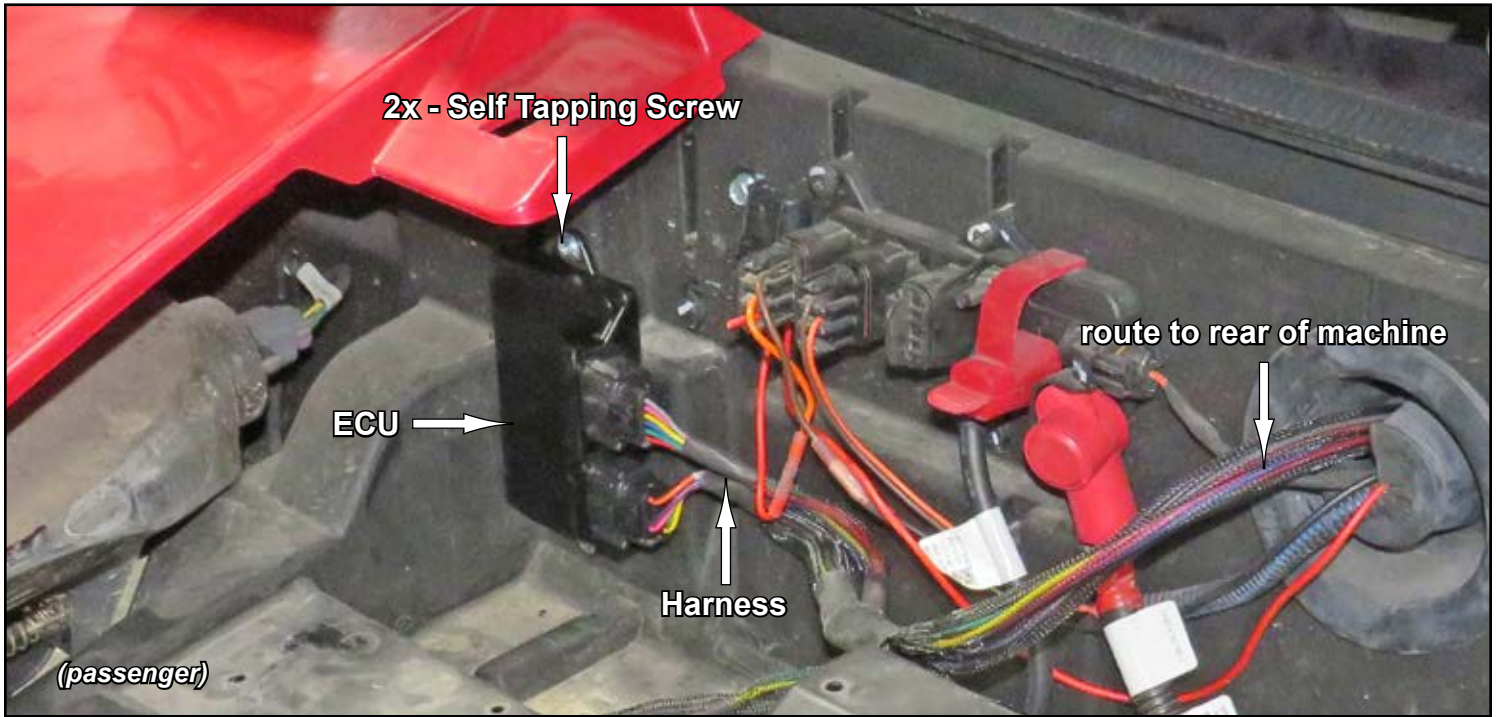

## LED Signals:

- User may install in locations different than shown.
- Illustration is SuperATV's choice.
- Drill a  $\text{\O}3/4$ " hole in body and install LED Signal. Repeat for remaining LED Signals.
- Plug LED Signals into corresponding inputs on Harness.
- Secure all Wires as needed.



**If Light is hard to insert separate as shown.**

- Separate LED from Gasket.
- Install Gasket into hole.
- Install LED into Gasket.

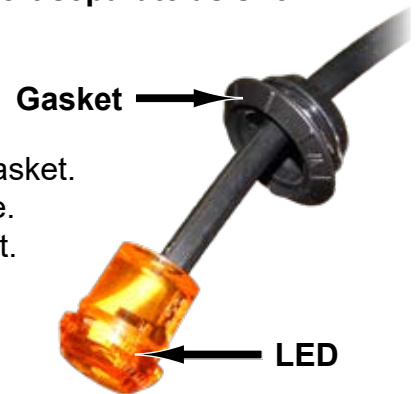

**Rear:**

- Raise Bed and disconnect stock Harness.
- Connect Harness to stock Harness.
- Secure all Wires as needed.
- If connecting License Plate Light (not included), do so at this time.

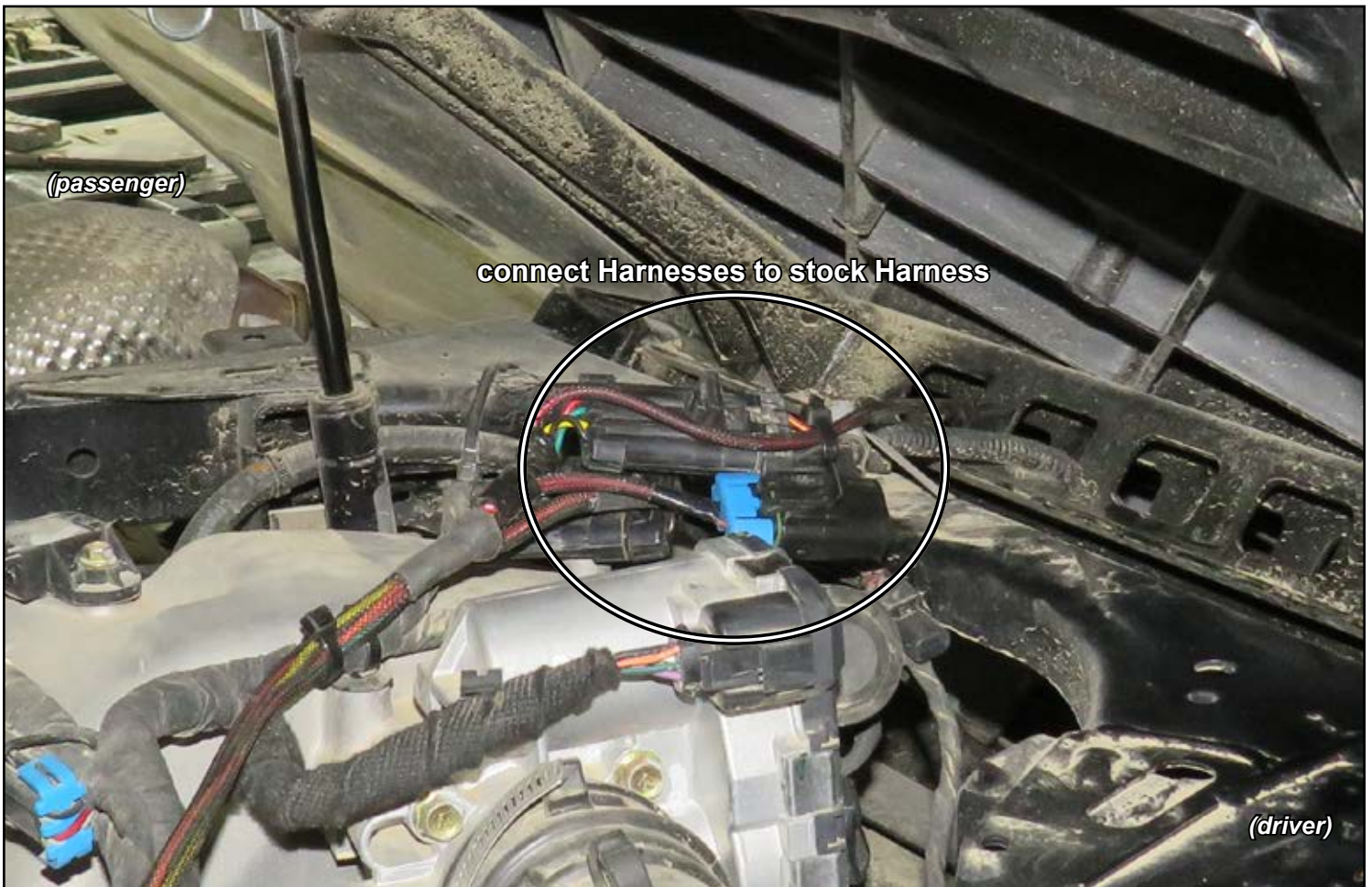

## **Switch Mounting:**

- User may install Switches in locations different than shown.
- Verify that Wire Harness will reach Switches before mounting.

**SuperATV recommends testing Switches before permanently mounting.**



- Connect Switches and secure.

### **Switch Templates**

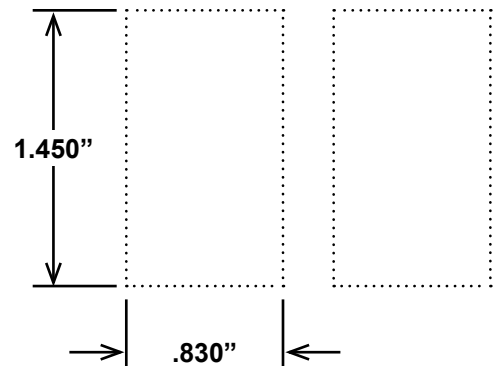



#### CUSTOMER NOTIFICATION AND DISCLAIMER LIABILITY

**This product is a modification for utility task vehicles and all terrain vehicles. Use this product at your own risk.**

**Warranty and Liability Limitations.** The Buyer hereby assumes all risks associated with the use and/or installation of this product. Buyer waives all liability claims against SuperATV® of any kind or nature, including, but not limited to, liability for penalties, fines, property damage, personal injury or death, to the fullest extent permitted by law. Buyer acknowledges and agrees that SuperATV® is not liable for any direct, indirect, incidental, consequential or special damages, including but not limited to, damage, loss of life, loss of property or equipment, loss of profits or revenue, injury, or claims from any individual or entity arising from the use of this product.

The warranty for this product, if any, may give you ("Buyer") specific legal rights, and Buyer may also have other rights which may vary from state to state. The installation of this product may void or otherwise adversely affect your factory warranty.

Consult your vehicle warranty before using this Product. Under no circumstances will SuperATV® be liable for the voidance of the Buyer's vehicle warranty. Buyer assumes all risk and responsibility if a manufacturer and/or dealer voids the Buyer's vehicle warranty due to use of this Product.

**Safety and Laws.** Operate your vehicle at all times in a safe manner. You must abide by all local, state, and federal laws, including but not limited to vehicle safety, traffic laws, and ordinances. It is your responsibility to know the laws and how they apply to you. The installation of this product may violate certain local, state, and federal laws. Be advised that laws vary depending on town, city, county, state, etc. Use of this product on public streets, roads, or highways may be in violation law. The Buyer is solely and exclusively legally and personally responsible for any violation of the law by the installation or use of this product. In no case will SuperATV® be held liable if Buyer violates the law or uses the product in an unsafe manner.

The Buyer is responsible to fully understand the capability and limitations of his/her vehicle according to manufacturer specifications, warnings and instructions and agrees to hold SuperATV® harmless from any damage resulting from failure to adhere to such specifications, warnings and/ or instructions. The Buyer is also responsible to obey all applicable federal, state, and local laws when operating his/her vehicle while using this product, and the Buyer agrees to hold SuperATV® harmless from any violation thereof.

**Installation.** The installation of this product on your vehicle indicates that you have had the opportunity to inquire about applicable local, state, and federal laws and ordinances and that you have read and understand, and accept all of the terms of, this Disclaimer.

SuperATV® shall not be responsible for the proper installation, use, and service of this product. Rather, the Buyer shall be solely responsible for the installation of the product and any damage that may be done to the vehicle or vehicle components as a result of modifications made by the Buyer.

## Accessory to Turn Signal Kit Wiring

Left Turn Signal Harness shown in illustrations.



## Accessory to Turn Signal Kit Wiring continued



SuperATV recommends using a handheld mini torch, or lighter, to activate heat shrink on Connector.