

98-99.5

7.3 **DiT** Power Stroke

Direct Injection Turbocharged Diesel Engine

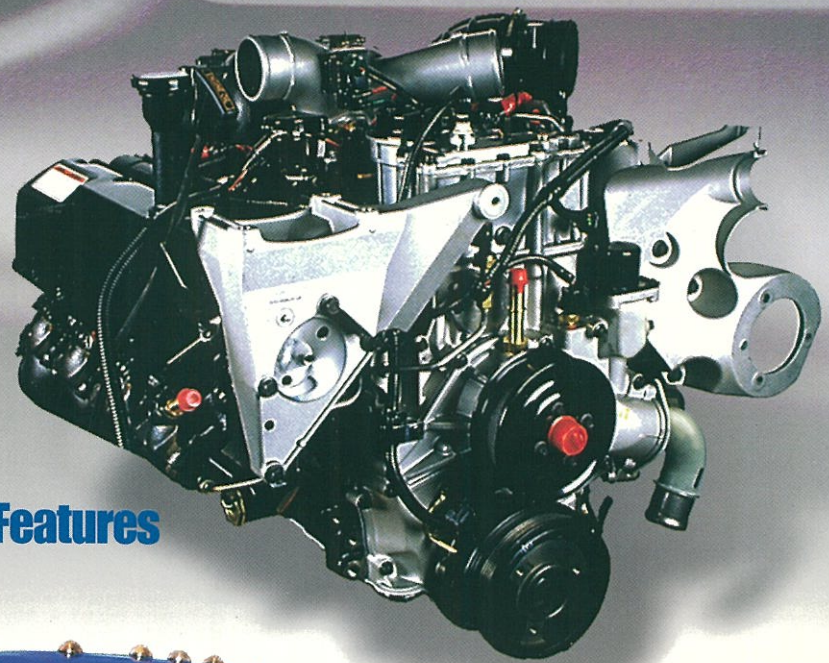

**"F" Series
Super Duty**

Features • Description • Service Features



FOREWORD

This publication is intended to provide technicians and service personnel with the latest technical advancements incorporated in the 7.3 DIT Diesel Engine. The information contained in this publication will supplement information contained in available service literature.

IMPORTANT SAFETY NOTICE

Appropriate service methods and proper repair procedures are essential for the safe, reliable operation of all motor vehicles, as well as, the personal safety of the individual doing the work. This manual provides general directions for accomplishing service and repair work with tested, effective techniques. Following them will help assure reliability. There are numerous variations in procedures, techniques, tools, and parts for servicing vehicles, as well as, in the skill of the individual doing the work. This manual cannot possibly anticipate all such variations and provide advice or cautions as to each. Accordingly, anyone who departs from the instructions provided in this manual must first establish that he compromises neither his personal safety nor the vehicle integrity by his choice of methods, tools or parts.

The following list contains some general WARNINGS that you should follow when you work on a vehicle.

- Always wear safety glasses for eye protection.
- Use safety stands whenever a procedure requires you to be under the vehicle.
- Be sure that the ignition switch is always in the OFF position, unless otherwise required by the procedure.
- Never perform any service to the engine with the air cleaner removed and the engine running unless a turbocharger compressor inlet shield is installed.
- Set the parking brake when working on the vehicle. If you have an automatic transmission, set it in PARK unless instructed otherwise for a specific service operation. If you have a manual transmission, it should be in REVERSE (engine OFF) or NEUTRAL (engine ON) unless instructed otherwise for a specific service operation.
- Operate the engine only in a well-ventilated area to avoid the danger of carbon monoxide.
- Keep yourself and your clothing away from moving parts when the engine is running, especially the fan, belts, and the turbocharger compressor.
- To prevent serious burns, avoid contact with hot metal parts such as the radiator, turbocharger pipes, exhaust manifold, tail pipe, catalytic converter and muffler.
- Do not smoke while working on the vehicle.
- To avoid injury, always remove rings, watches, loose hanging jewelry, and loose clothing before beginning to work on a vehicle. Tie long hair securely behind the head.
- Keep hands and other objects clear of the radiator fan blades.

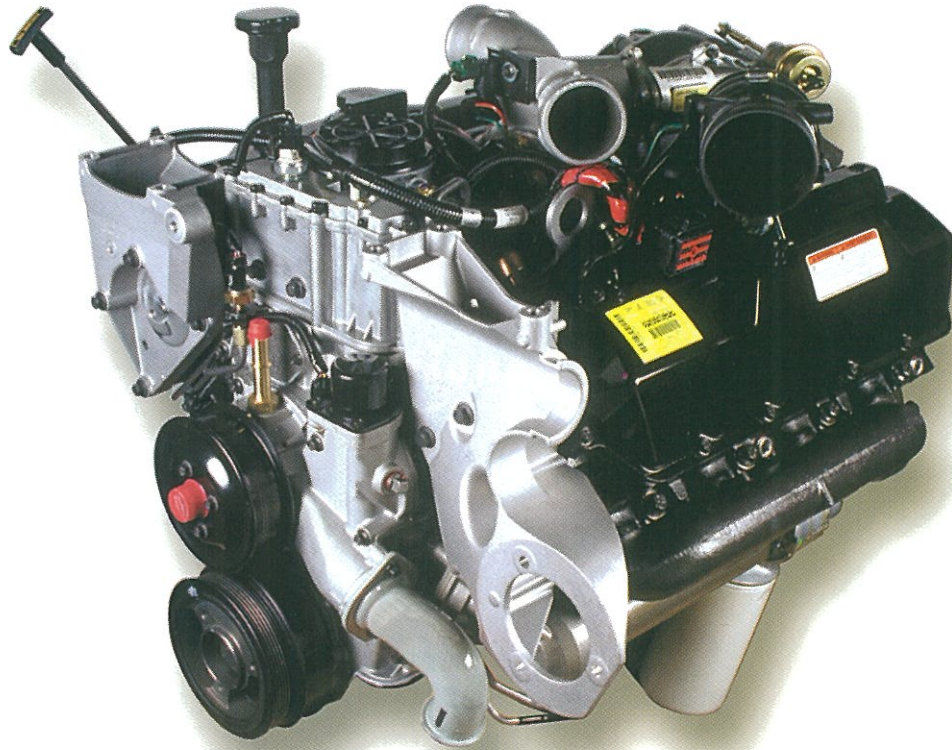

7.3 L D I T

**Direct Injection
Turbocharged Diesel
Engine**

TABLE OF CONTENTS

ENGINE SPECIFICATIONS	4
New Features	4
Engine Serial Number	4
Emission Label	5
Horsepower Comparison	5
Torque Comparison	5
PHYSICAL ID	6
AIR CHARGING SYSTEM	13
Turbo Id	13
Wastegate Control	15
TURBO REMOVAL AND INSTALLATION	18
FUEL CHARGING SYSTEM	21
Injectors	21
Fuel Filter and Supply	24
High Pressure Oil System	29
NEW AND REVISED SENSORS	31
SPECIAL TORQUE DATA	33
7.3L DIT ANTHOLOGY	35
Fuel filter service	35
DIAGNOSTIC GUIDES AND FORMS	50
GLOSSARY	71
INDEX	73

ENGINE SPECIFICATIONS

New Features

"F" Series

Increased Horsepower and Torque
Charge Air Cooled
Electronically Controlled Wastegated Turbo
All Split Shot Injectors
Snap to Connect ICP Oil Lines
Redesigned Fuel System

Econoline

Snap to Connect ICP Oil Lines
Redesigned Fuel Supply System
All Split Shot Injectors (Carryover from 1997 Model Year)

Chassis Power Train Changes



Chassis Mounted Electric Fuel Pump
ZF 6 Speed Manual Transmission (F-Series only)
Low Gear Added for Heavy Loads
Differential Ratios Available:
"F" Series: 3.73, 4.10, 4.30, 4.88
Econoline: 3.55, 4.10, 4.63
Single 35 gallon Fuel Tank (F-Series only)

Engine Serial Number

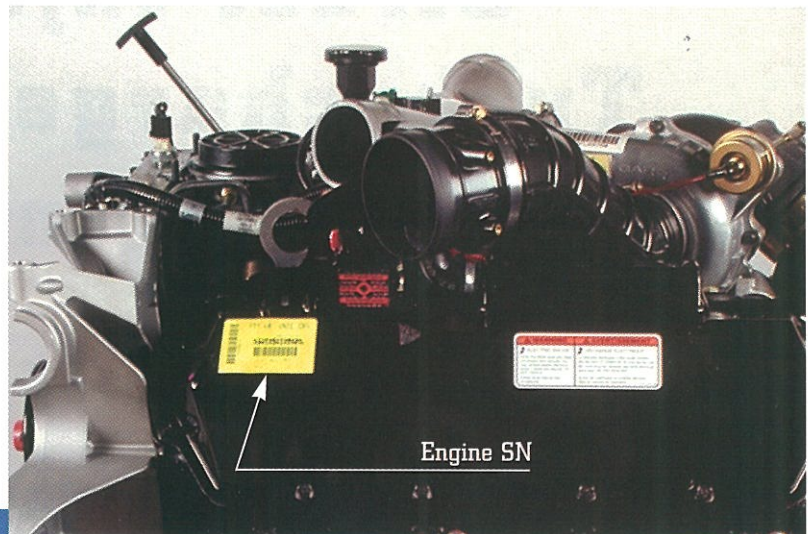
- There is now an engine serial number on the valve cover as opposed to the oil reservoir.
- As with previous *Power Stroke* engines, the engine serial number is still stamped into the crankcase at the rear oil cooler pad.
- The vehicle production date break for most of the material covered in the front section of this book is **Jan. '98**, unless otherwise stated in text.



ENGINE SPECIFICATIONS

 INTERNATIONAL 7.3 DIT ENGINE FAMILY XNVXH07.3FCC FAMILLE DE MOTEUR 7.3 DIT	1999 MODEL/MODÈLE	A250	
	ADV. BHP @ RPM (PUISS. NOM.À TR/MIN)	250 @ 2700	
	CURB IDLE, FUEL RATE @ ADVERTISED POWER, AND INJECTION TIMING ARE NON-ADJUSTABLE. LE RÉGIME DE RALENTI, LE DÉBIT DE CARBURANT A LA PUISSANCE NOMINALE ET LE CALAGE DE L'INJECTION SONT NON-RÉGLABLES.		
	EMISSION CONTROL SYSTEM: - SYST. DE DÉPOLLUTION: ECM, TC, DI, OC, CAC		
	DISPLACEMENT/CYLINDRÉE: 7.3L		
THIS ENGINE HAS A PRIMARY INTENDED SERVICE APPLICATION AS A LIGHT HEAVY-DUTY DIESEL ENGINE AND CONFORMS TO U.S. EPA, CANADIAN, AND AUSTRALIAN ADR-30 1999 MODEL YEAR REGULATIONS. THE ENGINE IS ALSO CERTIFIED FOR SALE IN CALIFORNIA IN NEW VEHICLES RATED ABOVE 14,000 POUNDS GVWR AND IS CERTIFIED TO OPERATE ON DIESEL FUEL. THIS ENGINE IS OBD II EXEMPT. CE MOTEUR A ÉTÉ PRINCIPALEMENT CONÇU EN TANT QU'UN MOTEUR DIESEL ROBUSTE DE GAMME LÈGÈRE ET EST CONFORME À UX RÈGLEMENTS DE L'EPA AUX É.-U. ET CANADIENS DE L'ANNÉE DE MODÈLE 1999. CE MOTEUR EST AUSSI CERTIFIÉ POUR ÊTRE VENDU EN CALIFORNIE SUR LES VÉHICULES NEUFS D'UN PBV D'AU-DELÀ DE 14 000 LB ET EST CERTIFIÉ POUR FONCTIONNER AU CARBURANT DIESEL. CE MOTEUR EST EXEMPTÉ DE L'EXIGENCE OBD II.			
EMISSION CONTROL INFORMATION RENSEIGNEMENTS DE DÉPOLLUTION ENGINE MANUFACTURED BY: MOTEUR FABRIQUÉ PAR: NAVISTAR INTERNATIONAL TRANSPORTATION CORP.  1831044C1			

Emission Label

- The emission label is located on the right valve cover and identifies the engine model, gross horsepower, and fuel delivery rate.

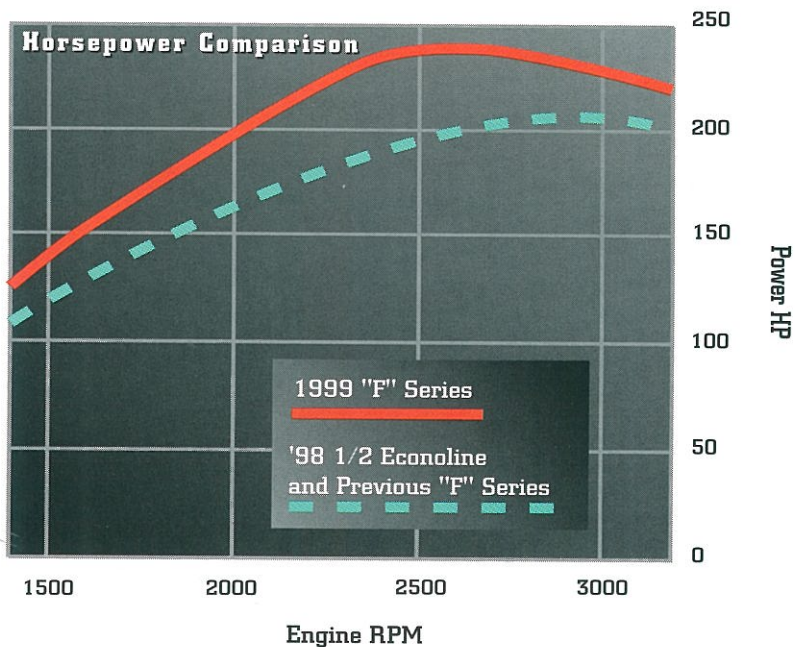

Horsepower Comparison

1999 "F" Series

Peak Horsepower is 9% more than previous models and occurs @ 2700 RPM versus 3000 RPM.

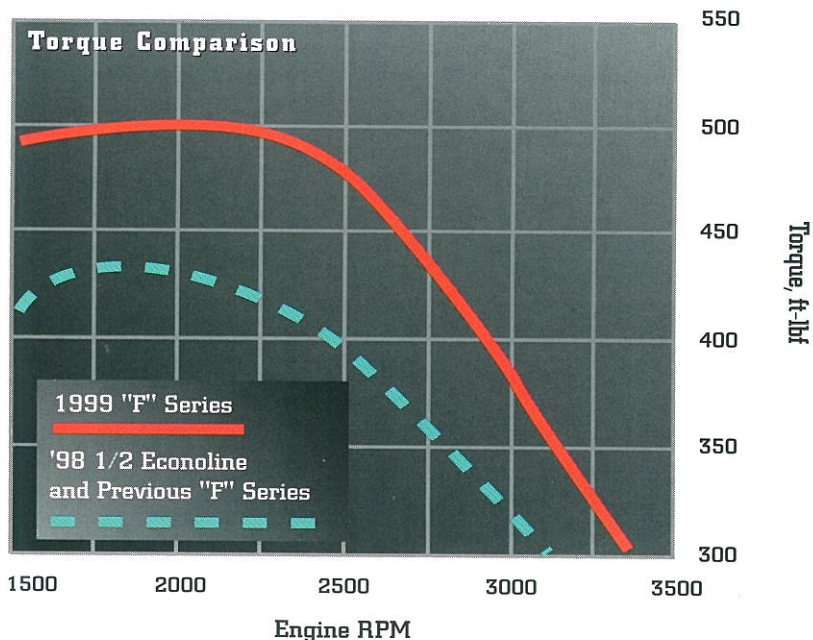

Torque Comparison

Similar to the horsepower increase, peak torque is higher at 500 lb/ft. between 1600 and 2300 RPM. This is a 15% increase over prior models.

PHYSICAL ID

Crankshaft

- For improved strength and ease in machining, the crankshaft no longer has lightening holes drilled into the connecting rod pins.
- The counterweights are larger to counteract the extra weight in the connecting rod pin.
- The engine serial number break for this change is **576010**.

Note: The “larger” crankshafts may only be used in crankcases with serial numbers higher than 571930.

Engine Serial
#576010 and above

Engine Serial
#576009 and below

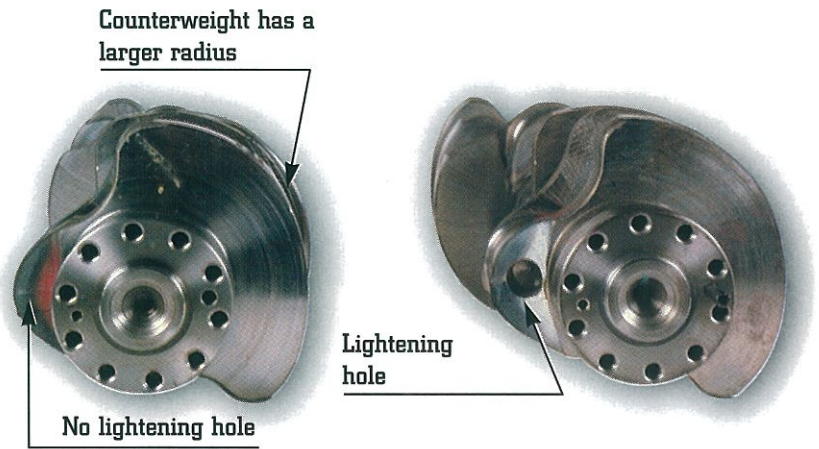

Crankcase

- The lower section of the crankcase has been modified to allow larger crankshaft counterweights to clear the crankcase.
- The serial number break for this change is: **571930**.
- This change occurred on the crankcase prior to the crankshaft.

Note: This crankcase may be used with either crankshafts described above.

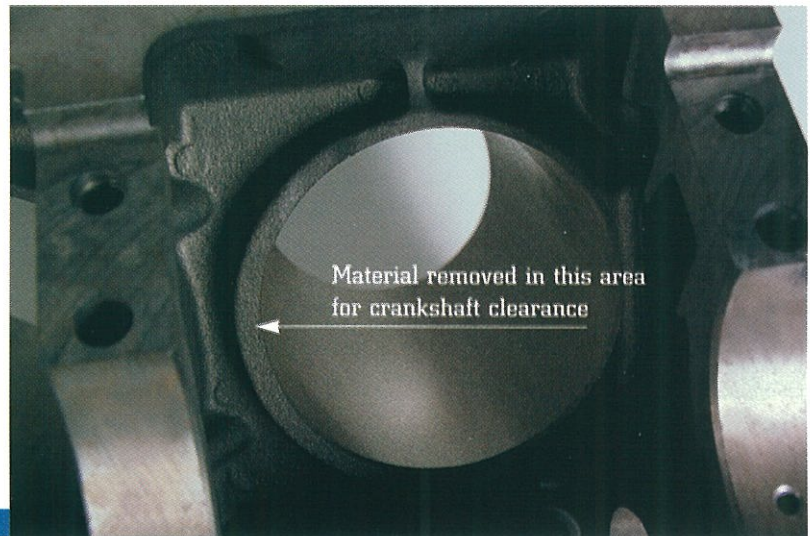

Camshaft

- The 1999 model year engine incorporates a chassis mounted electric fuel pump.
- Due to the use of an electric fuel pump the eccentric lobe on the camshaft has been eliminated.

Mechanical lift pump eccentric eliminated

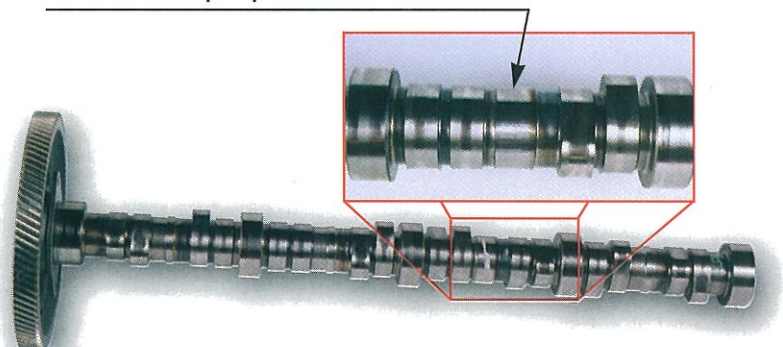

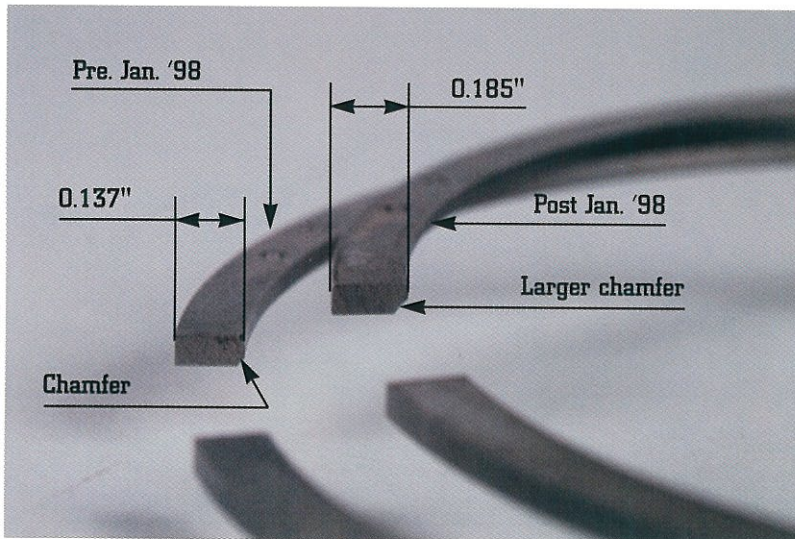

Rings

- The intermediate ring width has been increased to increase ring tension in the bore.
- The intermediate ring has a larger chamfer on its inside face and increased width to distinguish it from the prior second ring.

Note: The intermediate ring must not be used on earlier pistons.

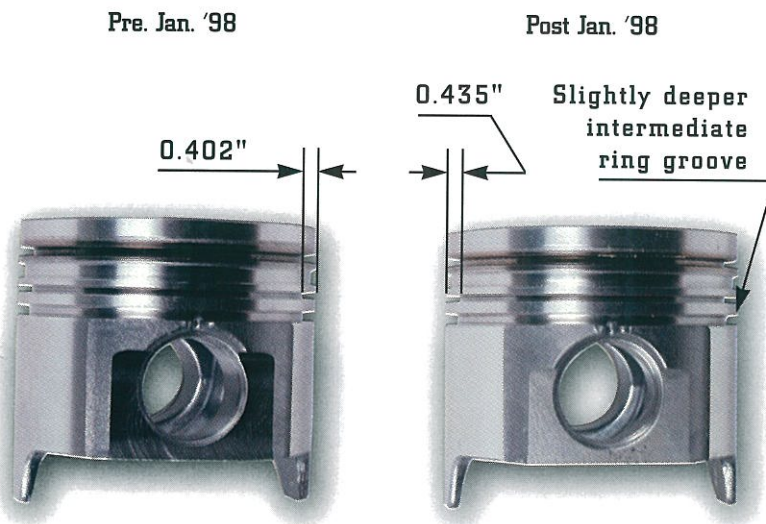

Pistons

- The new piston has a deeper intermediate ring groove to accommodate the new increased intermediate ring width.

Note: Pistons and rings cannot be intermixed due to increased and narrow intermediate ring widths.

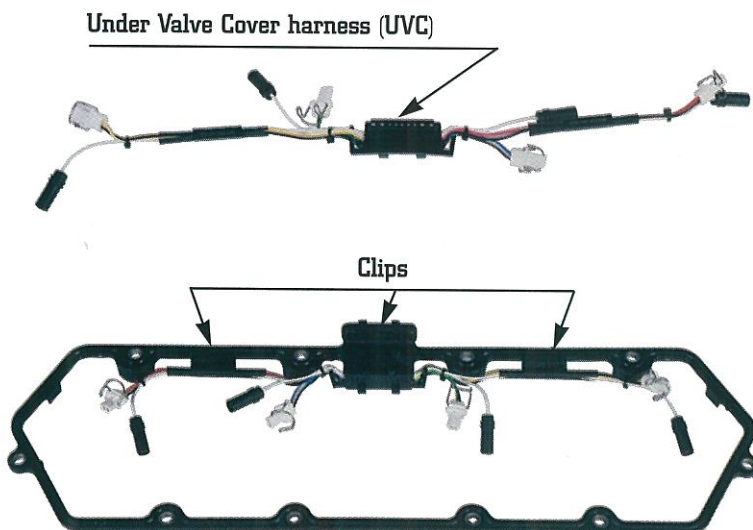

Valve Cover Gasket and UVC Harness

- To reduce the number of electrical connections and improve reliability, the valve cover gasket now uses a single 9 pin connector (versus two 5 pin), for injectors and glow plugs.
- This new one piece design UVC is still removable, and uses larger wires and terminals for the glow plug circuit.

PHYSICAL ID

Engine Harness

- Similar to the UVC harness, the engine harness also has two 9 pin connectors, incorporating larger wires and terminals for the glow plugs.

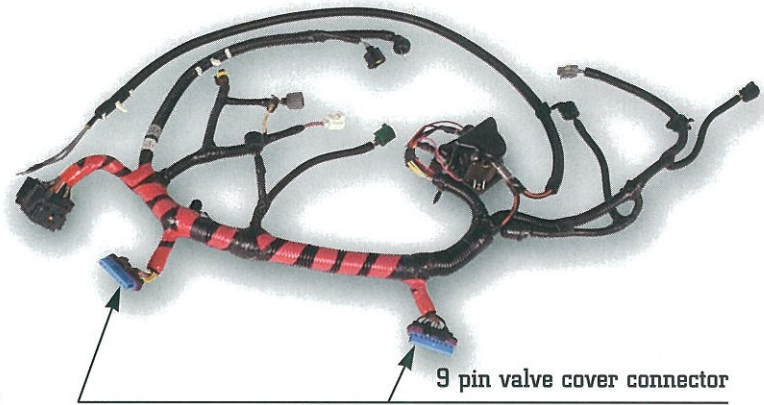

Valve Cover Gasket Breakout Tool

- Because of the new 9 pin connector, essential tool #418-F221 has been released for testing glow plug and injector circuits.
- The four White pins are for glow plugs.
- The Black pin is common for the four injectors.
- Red, Green, Blue, and Yellow pins are injector ground.

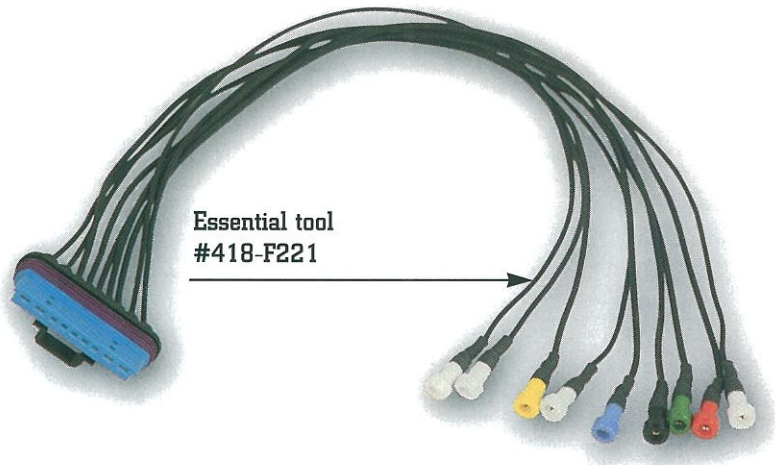

Exhaust Up Pipes

- To improve joint serviceability, the exhaust up pipes are now common for both "E" and "F" Series.
- On previous engines the exhaust up pipes were model specific. The previous "F" series drivers side exhaust up pipe is shown.

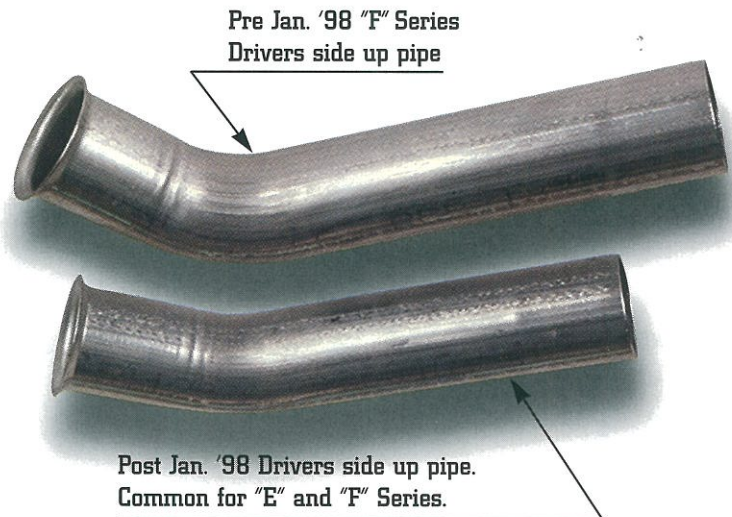

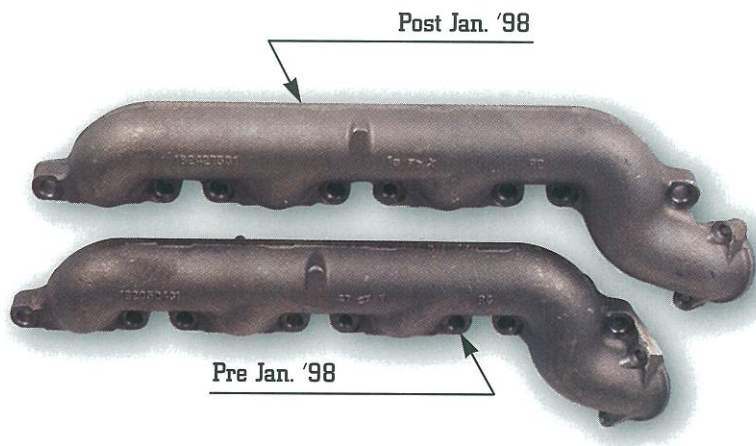

Exhaust Manifolds

- The driver side “F” Series exhaust manifold has changed to allow the use of a common exhaust up pipe.

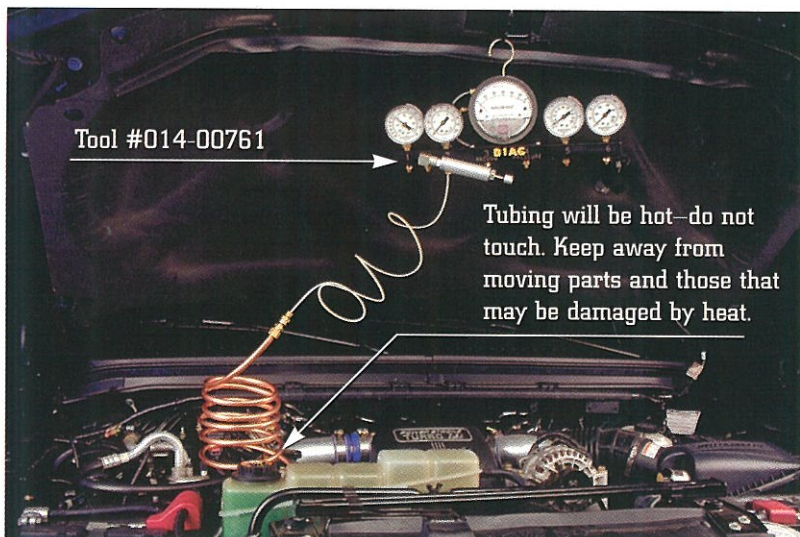
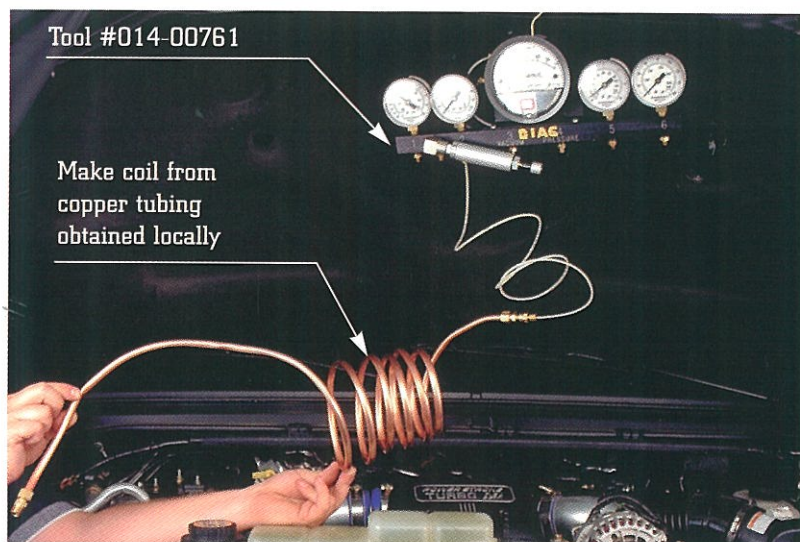

Measuring Exhaust Back Pressure without Cold Weather Package

- With the 1999 model year “F” Series, a “Cold Weather option delete” package is available. If the cold weather package has been deleted, a new procedure for checking exhaust back pressure is described below.
- To check exhaust back pressure on a vehicle that is not equipped with an exhaust back pressure sensor, you will have to make your own cooling coils.
- The coils are to cool exhaust gases before they reach the pressure gauge to avoid damage to the gauge.
- The coil should be made out of copper tubing obtained locally.
- After making coil, attach tubing to the exhaust manifold by removing the plug in front of the right exhaust manifold where the exhaust back pressure sensor tube would normally be located.
- Use gauge bar tool number **014-00761** or equivalent to read pressure; on vehicles equipped with EPB this can be read using the NGS tool.

CAUTION: TURBO WILL BE HOT. Do not touch during or immediately after test. Route tubing away from parts that can be damaged by heat and keep away from accessory drives and fan.

PHYSICAL ID

Turbine Inlet and Clamp

- The turbine inlet now uses a V-band style clamp for mounting.
- To insure proper alignment a dowel pin is used as a locator.

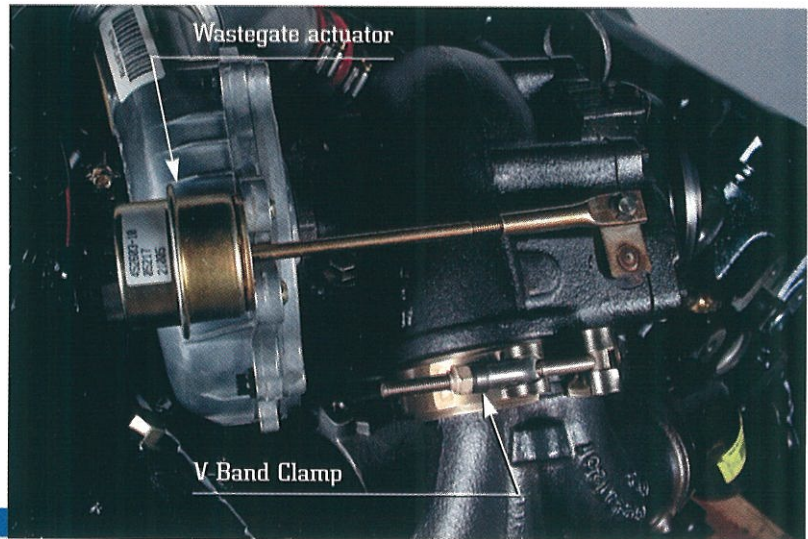

Oil Fill Location and Dipstick

- The engine oil fill location has been extended to make it easier to change or add oil to the engine.
- The dipstick is now common for both "E" and "F" series. This makes it easier to check the oil level on "F" series.

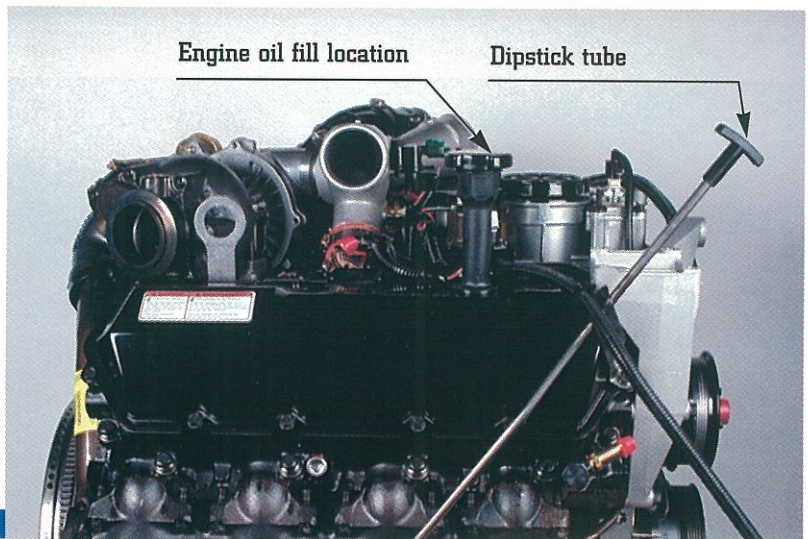

Crankcase Pressure Test

- Place crankcase pressure adapter on oil fill extension to check pressure.
- Crankcase pressure should not be more than **4 inches of water** using the Magnahelic gauge.

Note: Be sure to block off crankcase ventilation system (breather tube) before performing test.

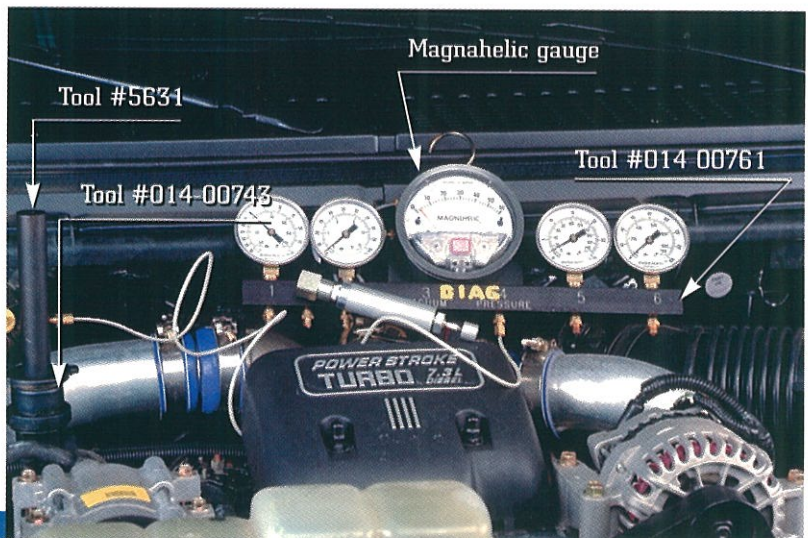

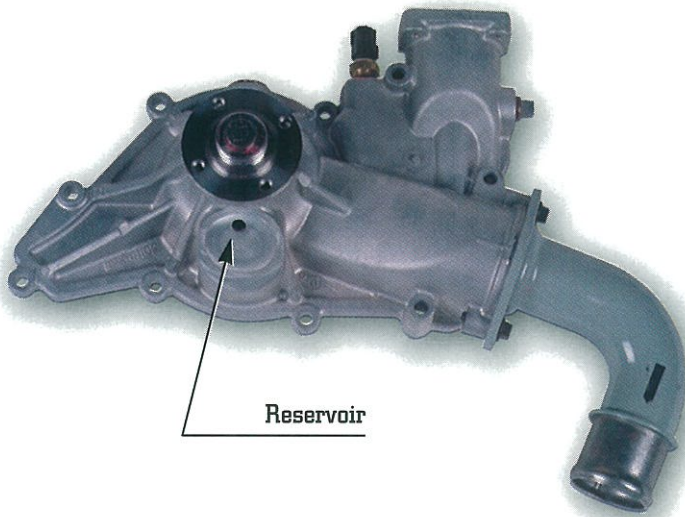

Reservoir

Post Jan. '98 "F" Series
thermostat housing

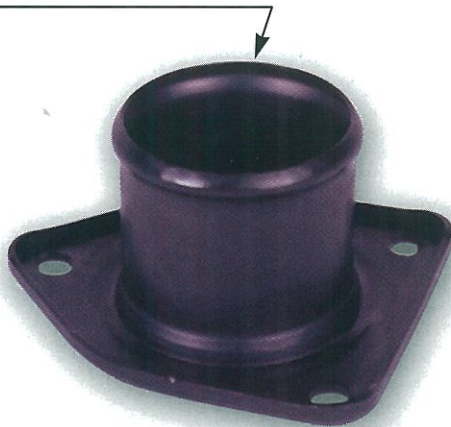

Pre Jan. '98



Post Jan. '98



Water Pump

- Water pump seals are dynamic seals. During engine cranking, seepage past the seal occurs.
- A reservoir has been added to the housing to allow the small amounts of seepage past the seal to accumulate and evaporate.
- This eliminates the staining seen on prior water pumps.

Thermostat Housing

- To provide clearance for charge air cooler piping and improve serviceability during normal service operations, the "F" Series thermostat housing is shorter, has a thicker flange and a new seal.

Water Pump Pulley

- The water pump pulley diameter has been decreased.
- If service is required, be sure to use the proper pulley to obtain proper pump speed and avoid cooling system concerns.

Engine Mounts – "F" Series

- With the new Super Duty "F" Series chassis, the driver side engine mount is made from cast iron instead of stamped steel.

Pre Jan. '98



"F" Series
Left engine mount

Post Jan. '98



"F" Series
Left engine mount

Air Cleaner

- The air cleaner for the 1999 model year "F" series has been totally redesigned to use a flat rectangular filter element.
- The air filter housing continues to incorporate a filter minder restriction gauge to monitor air filter condition.

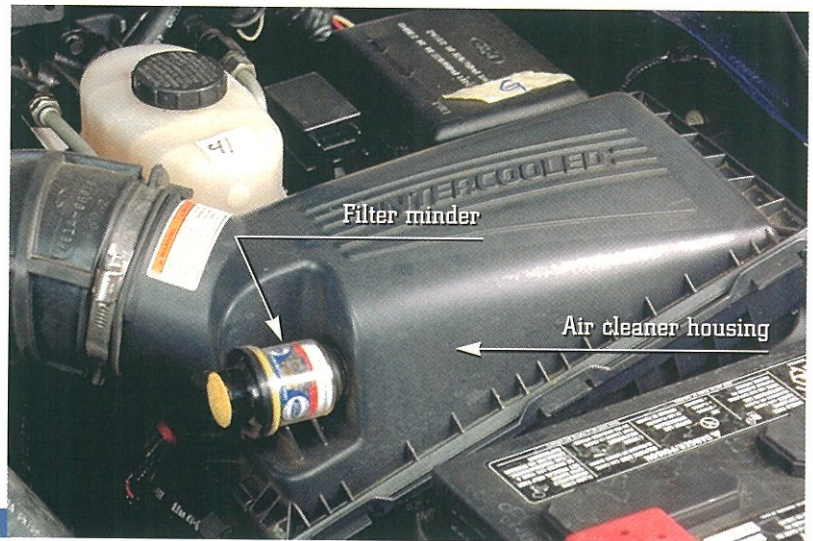

Single Mass Flywheel

- A single mass flywheel replaces the previously utilized dual mass flywheel for manual transmission applications.
- The flywheel can be identified by the absence of bolts that would normally connect the inertia member from the clutch surface.

Note: The single mass flywheel can only be used with the ZF 6 speed manual transmission.

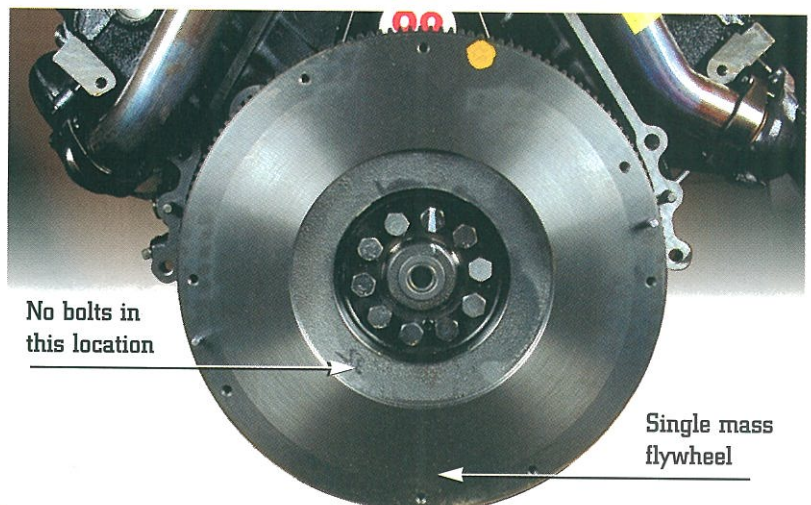

Turbo Charger

"F" Series

Wastegate with EBP

Wastegate without EBP

"E" Series

All with EBP – Non-Wastegated

- "F" Series turbochargers are wastegated in conjunction with charge air cooling.
- "F" Series may be ordered without EBP.
- All "E" Series turbochargers are equipped with EBP and no wastegate.

Turbo mounting bolt

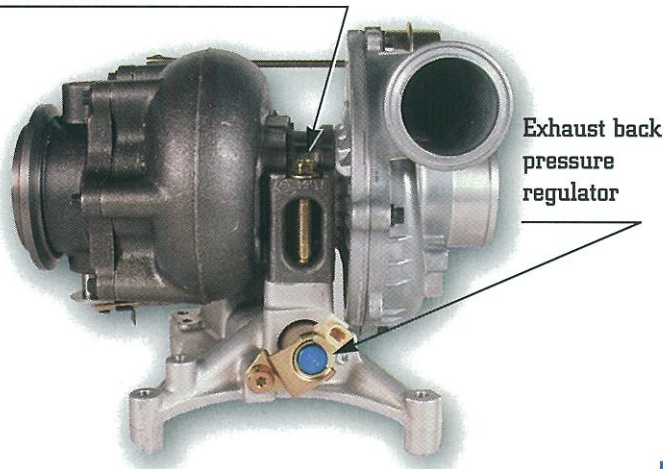

Turbo "F" Series with Wastegate and EBP

- In the front view shown, the EBP regulator and new top down turbo to pedestal mounting bolts are depicted.
- The wastegate regulates maximum speed of the turbocharger by allowing excess exhaust gases to bypass the turbine housing and be directed into the exhaust stream to atmosphere.

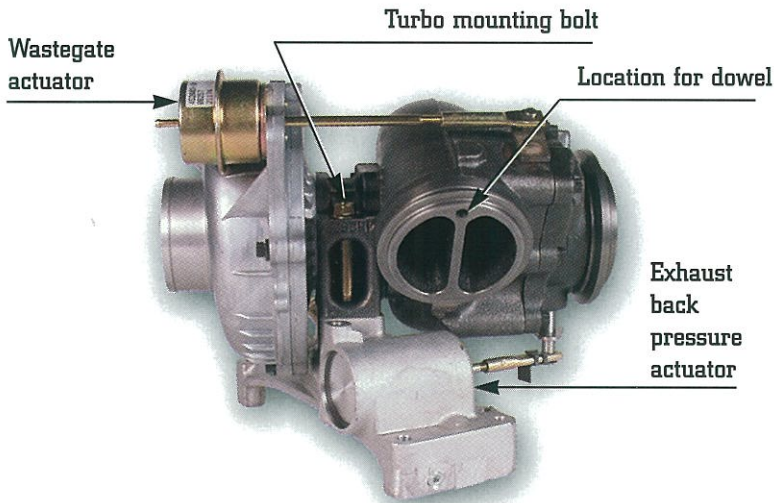

Turbo "F" Series with Wastegate and EBP

- From the rear view, EBP and wastegate actuators are shown. In addition, note the locator dowel hole for positioning the turbine inlet.
- As previously stated, the turbocharger assembly is now attached to the pedestal with two bolts from the top. This is for in chassis removal and installation of turbo assembly which is explained in detail starting on page 17.

AIR CHARGING SYSTEM

Turbo "F" Series with Wastegate and without EBP

- Front view shown with EBP regulator removed from turbo pedestal.

Turbo mounting bolt

No EBP regulator

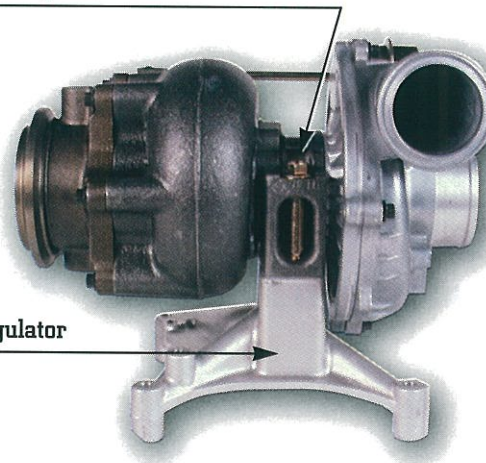

Turbo "F" Series with Wastegate and without EBP

- Rear view shown without EBP actuator assembly.
- The turbine inlet, not shown, utilizes an alignment dowel for positioning on the turbine housing.

Wastegate actuator

No EBP actuator

Location for dowel

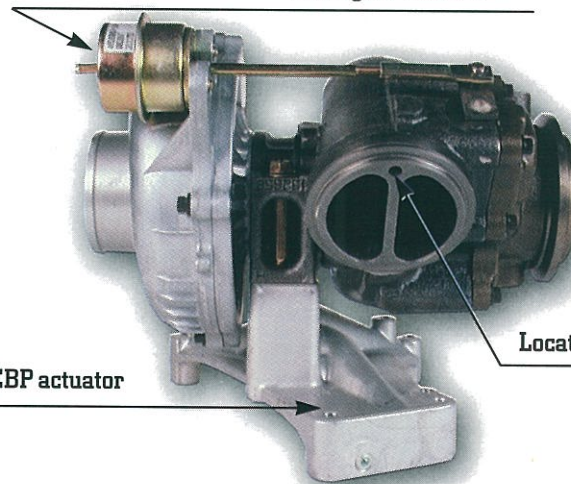

Turbo "E" Series without Wastegate and with EBP

- Front view shown with EBP regulator moved to front of pedestal and top down mounting bolts.
- Because the "E" Series does not utilize charge cooling, wastegated turbochargers are not incorporated in the Econoline engines.

Turbo mounting bolt

Exhaust back pressure regulator

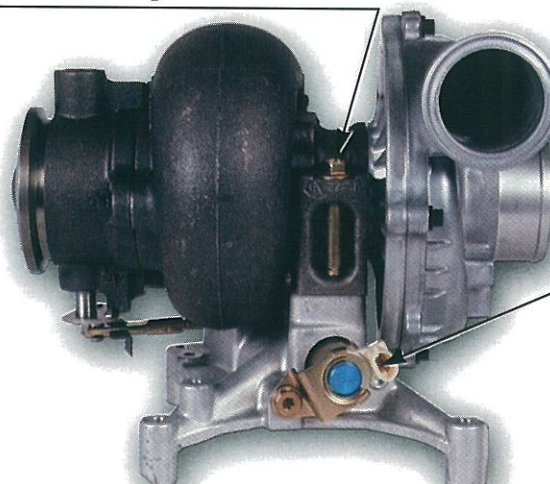

AIR CHARGING SYSTEM

Turbo mounting bolts

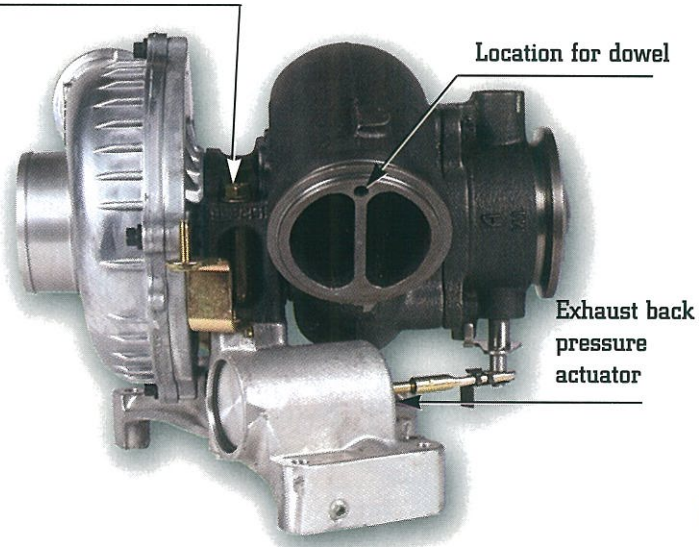

Turbo "E" Series without Wastegate and with EBP

- Rear view shown

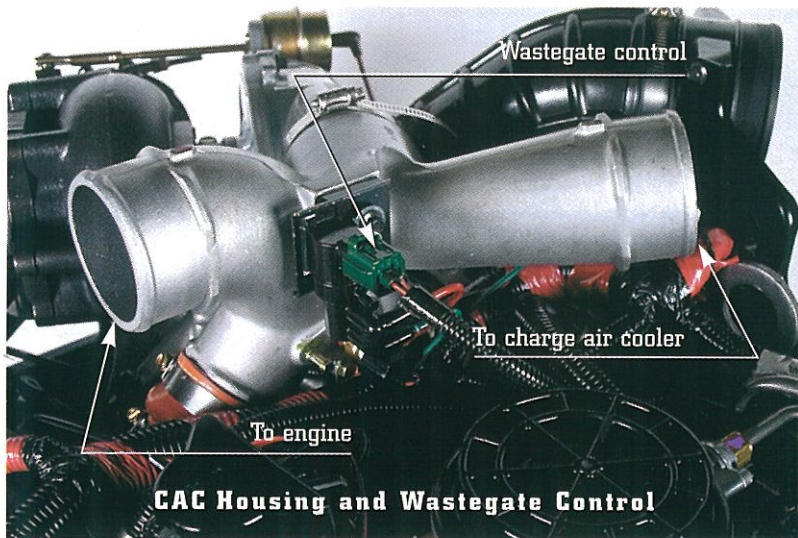

CAC Housing and Wastegate Control

Note: The inside of this housing will be damp with oil mist carry over from the closed crankcase ventilation system.

- Oil is not an indicator of a turbocharger concern.

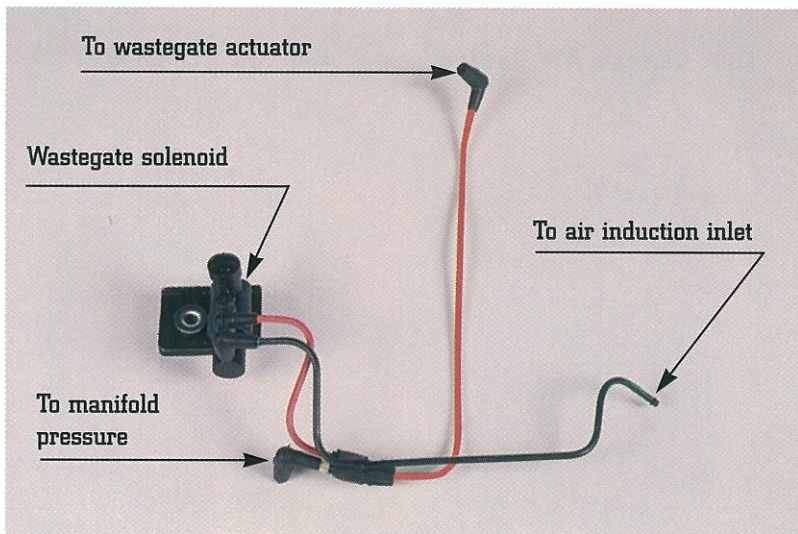

Wastegate Control Solenoid and Lines

- With the electronically controlled wastegate, a pressure differential between the induction system and the intake is used to regulate boost pressure, via a duty cycle controlled (PCM) solenoid.

AIR CHARGING SYSTEM

Wastegate Actuator Operation

- The wastegate actuator is a spring loaded diaphragm acted on by manifold pressure and controlled by the wastegate control (WGC) solenoid.
- The wastegate control solenoid, duty cycle controlled by the PCM, is allowed to bleed pressure via a hose connected to the air intake system for precise control.
- Spring pressure closes the wastegate.

Note: A tampered or disabled wastegate will result in decreased performance and potential turbocharger damage.

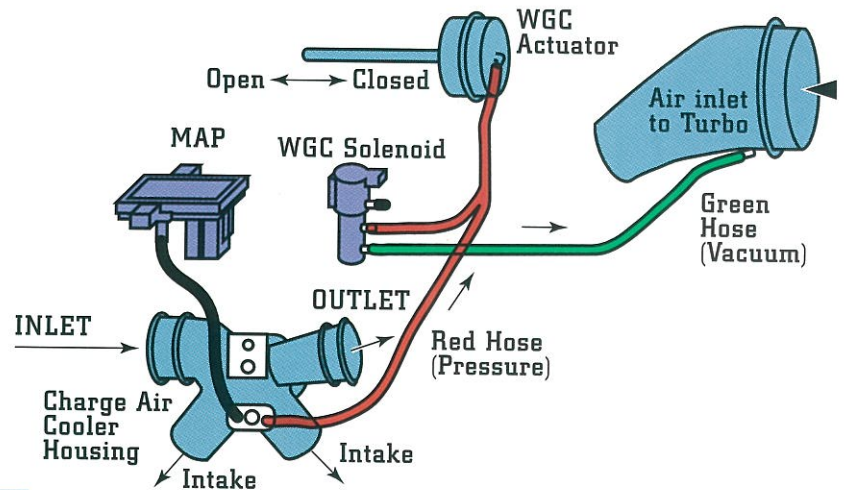

Wastegate Actuator Diagnostics

- To test the wastegate actuator, apply regulated air pressure to the actuator, starting at zero and slowly increasing pressure while observing actuator rod movement.
- The actuator should start to move at 5 psi.
- The actuator should hold 5 psi for 30 seconds.

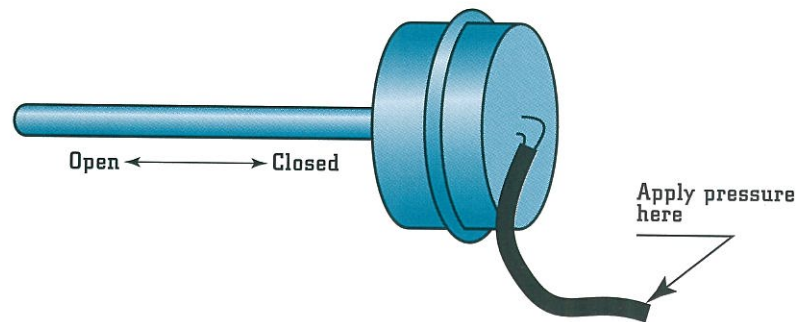

Non Charge Air Cooled

Charge Air Cooled



Intake to CAC Housing Hoses

- The CAC intake air hose has offset diameter inlet and outlet, this is due to the difference in the CAC housing and intake covers.

Note: Hoses are of special material and should not be substituted during service.

TURBO REMOVAL AND INSTALLATION

Note: Because of the addition of the charge air cooling piping, it is normal to hear some turbo noise (whine).

- If turbo noise is reported, first check to insure all sound insulating material is in its proper location, if not, install all insulation in proper locations.
- If all insulation material is in the proper locations, check for wheel to housing contact at the turbine or compressor, if there are signs of contact then replace the turbo.
- If the insulation is present and no wheel to housing contact is present, the sound may be normal.

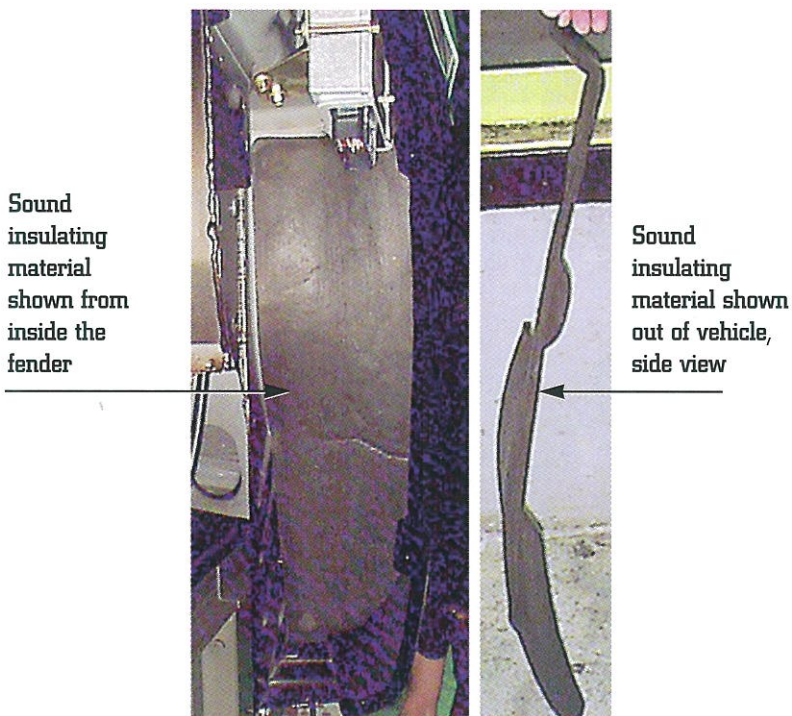
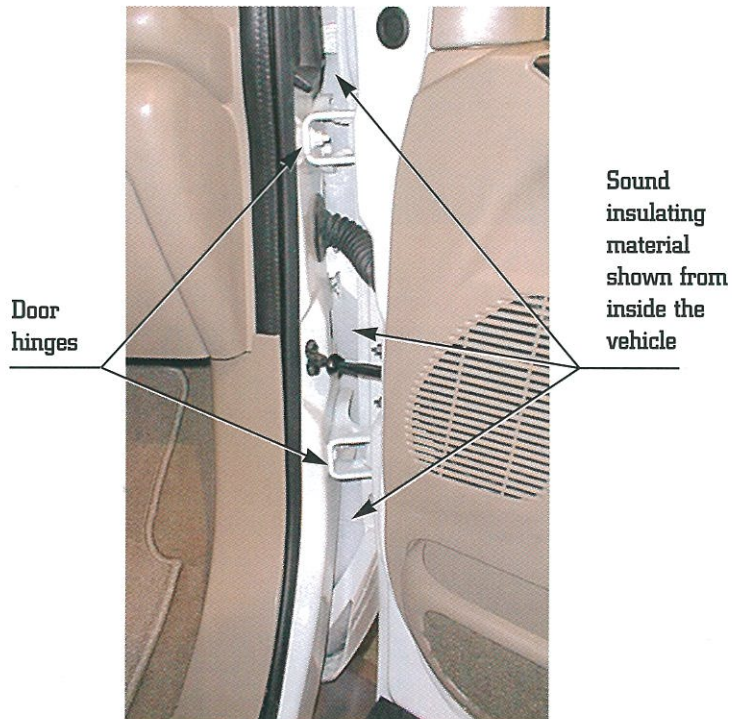

Sound Insulating Material for Engine Noise

- When diagnosing engine noise complaints, such as turbo whine, you must first check to see that all sound insulating material is in place as shown in accompanying photos.
- The material is in the fender and mounted between the fender and the A-pillar and is used to isolate the engine compartment from the vehicle's interior.
- There should not be any holes or gaps between the A-pillar and the fender.

TURBO REMOVAL AND INSTALLATION

CAC Pipes

- First remove the two nuts holding the *Power Stroke* cover in place.
- Then, loosen the four clamps that are holding the charge air cooler pipes to the charge air cooler housing.

Important: When reinstalling clamps, tighten to 71 lbf/in (8 Nm), to insure joint integrity, performance, and internal engine protection.

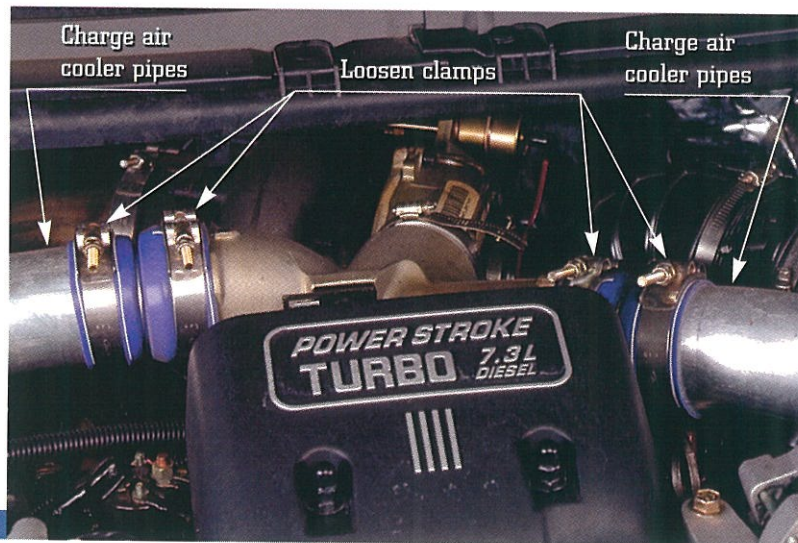

CAC Connections

Note: After removing the charge air pipes it is normal to see oil inside the flexible hose area.

CAUTION: When the intake system is open, care must be used to avoid any foreign objects from entering the engine or charge air cooler system.

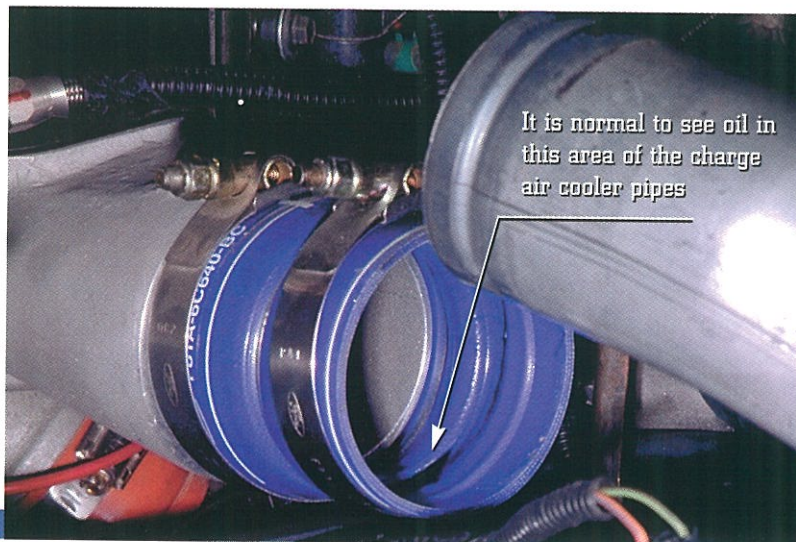

CAC Connections

- Next loosen the two clamps on both lower charge air cooler pipe connections at the charge air cooler, and move charge air cooler pipes out of the way to access the turbo.

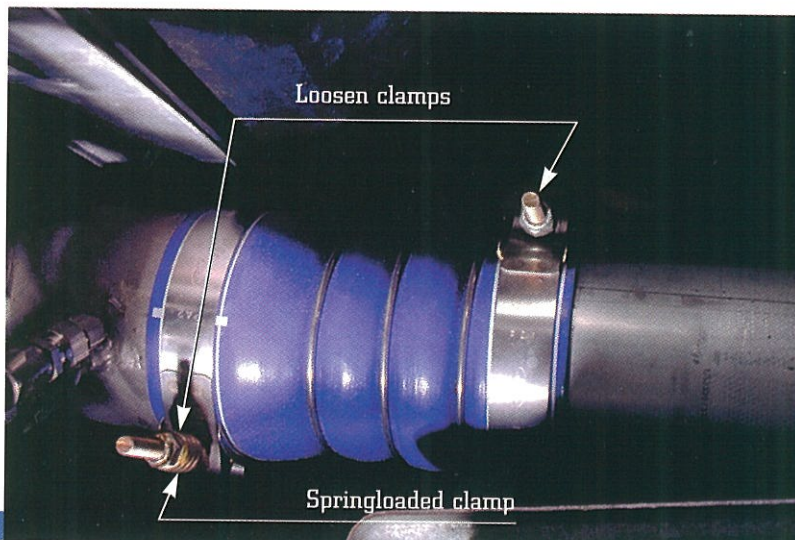

TURBO REMOVAL AND INSTALLATION

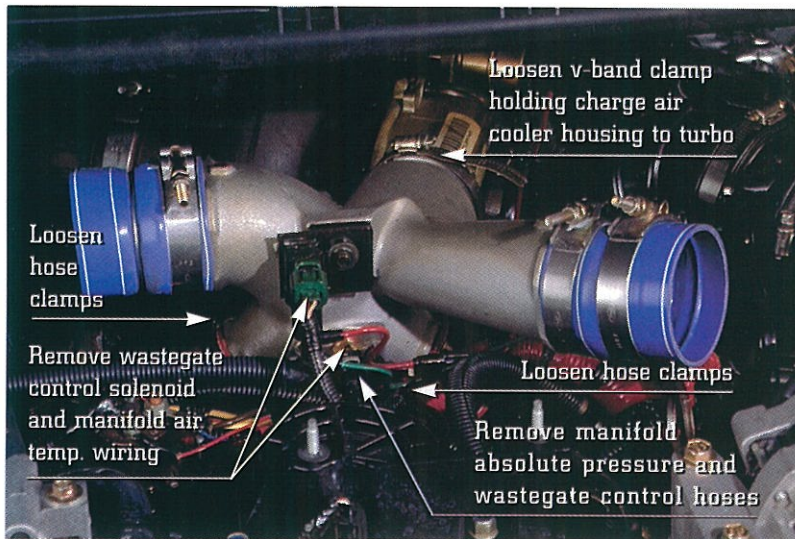

CAC Connections

- Remove all wiring and hoses going to the charge air cooler housing.
- Loosen hose clamps holding charge air cooler housing to turbo and intake covers.

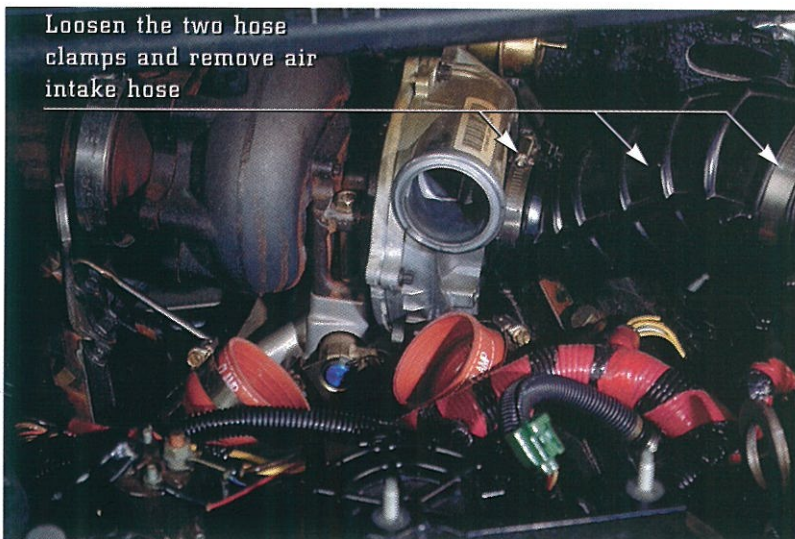

Air Induction Hose

- Loosen the two clamps holding the air intake hose to the turbo.
- Remove the air intake hose.

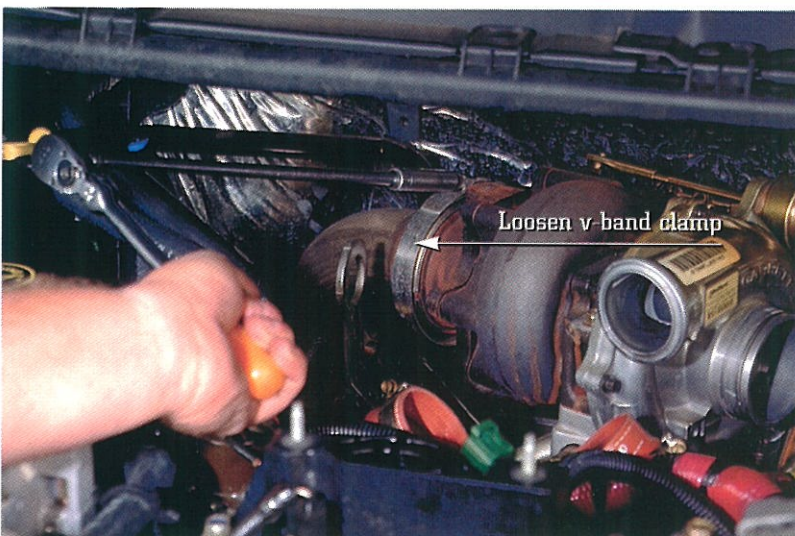

Exhaust Pipe

- Next loosen v-band clamp holding exhaust pipe to turbo.
- Move exhaust pipe out of the way for turbo removal.
- When reinstalling clamp, tighten to 50 lbf/in (5.6 Nm).

TURBO REMOVAL AND INSTALLATION

Exhaust Inlet Adapter

- Loosen the v-band clamp holding the exhaust inlet adapter to turbine.
- When reinstalling clamp, tighten to **100 lbf/in (11.3 Nm)**.

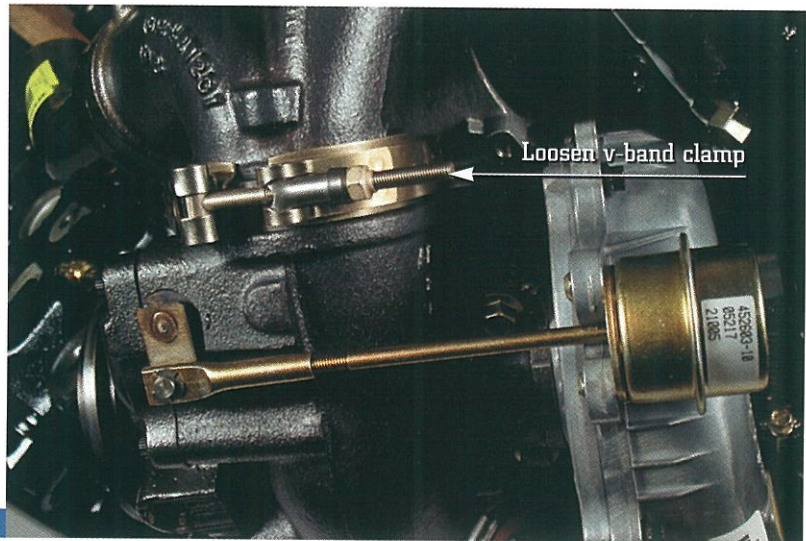

Turbocharger Assembly

Note: In-chassis removal and installation of turbo requires leaving the pedestal attached to the engine.

- Remove the two bolts holding the turbo to the mounting pedestal.
- When reinstalling bolts, tighten to **35 lbs/ft (4 Nm)**.
- To install turbo, reverse above steps.

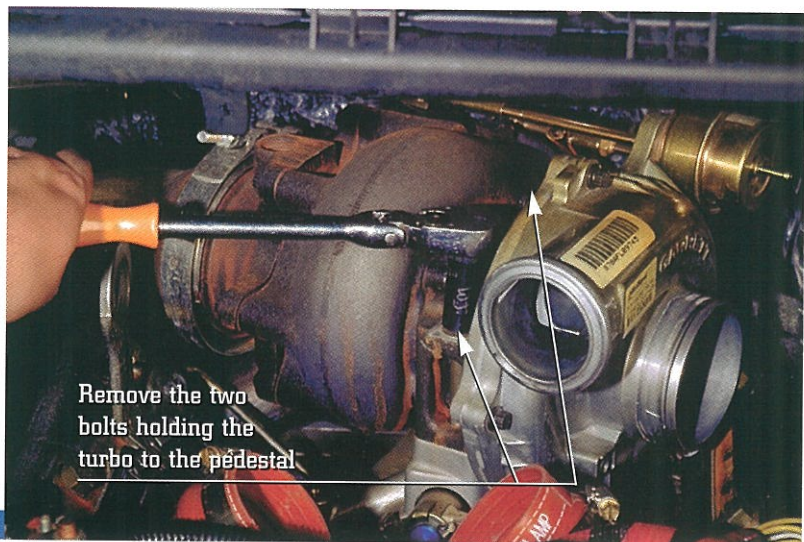



Injectors

- Split Shot
- O-Ring Pack

Fill Stage Step #1

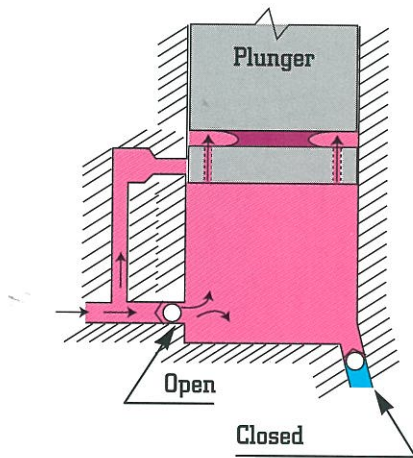

■ FUEL SUPPLY PRESSURE
■ INJECTION PRESSURE

First Injection Step #2

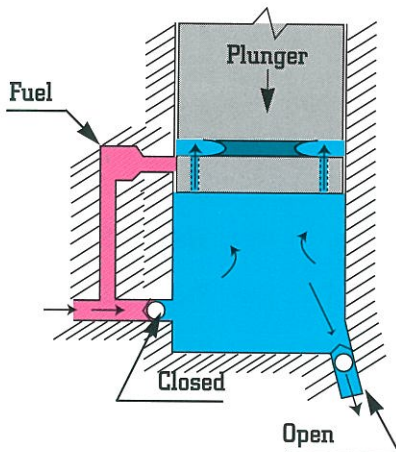

While the lower land of the plunger covers the upper port in the barrel, plunger movement increases pressure, unseats the delivery check ball, and begins fuel delivery

Split Shot Operation

Split shot injectors provide improved exhaust emissions and quieter engine operation, particularly at idle, by tailoring the injection of fuel, without a decrease in performance.

Split shot injectors (prime) have been used in California engines since the 1996 model year and all 1997 Econolines. Now they are in all *Power Strokes*.

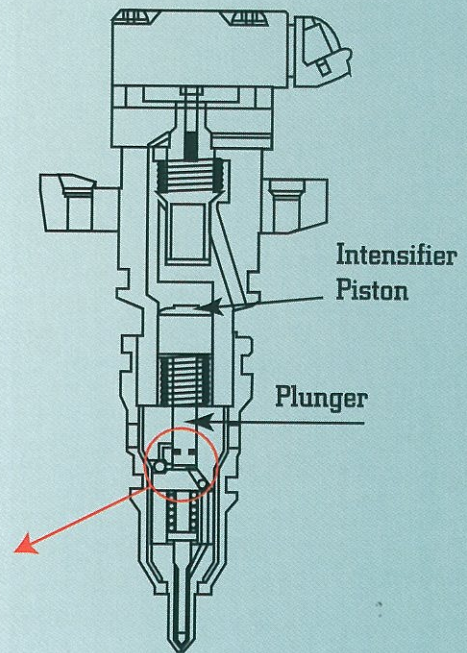

FUEL CHARGING SYSTEM

- FUEL SUPPLY PRESSURE
- INJECTION PRESSURE

End of First Injection Step #3

When the lower land travels past the upper port in the barrel, pressure decreases and fuel delivery is slowed.

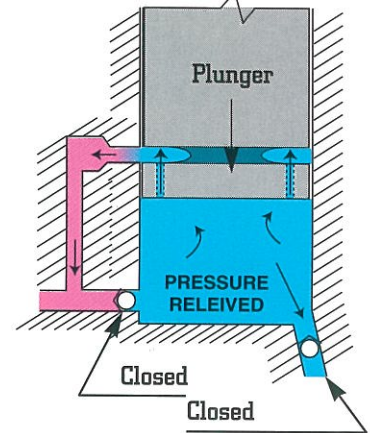

Second Injection Step #4

When the upper land seals the upper port in the barrel, as the plunger continues to move down, the delivery cycle is completed.

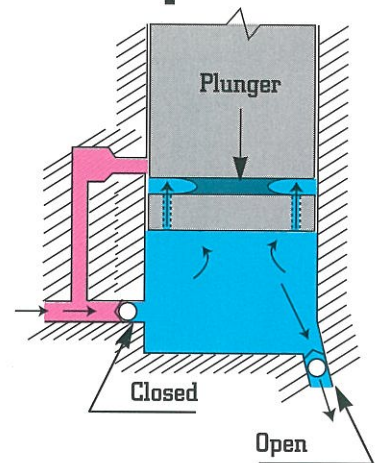

Injection Pressure

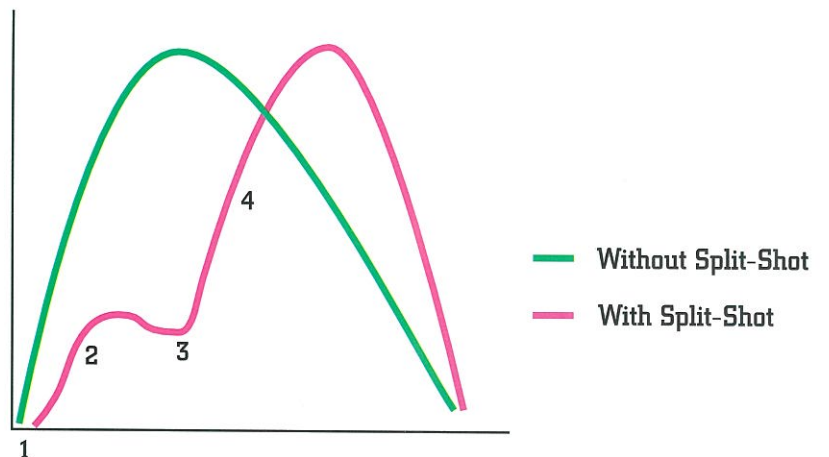

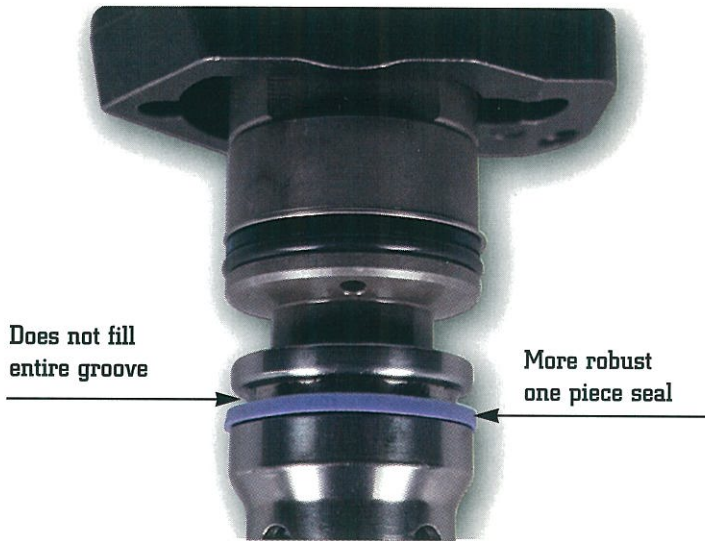

Injector O-rings

- The injector now uses a more robust one piece seal to replace the two previously used for the center position. No change was made to the injector.
- This change was incorporated as of engine serial number 642092.

Note: The O-rings are to be used when servicing all previous DIT engines. O-ring will fit loosely in groove.

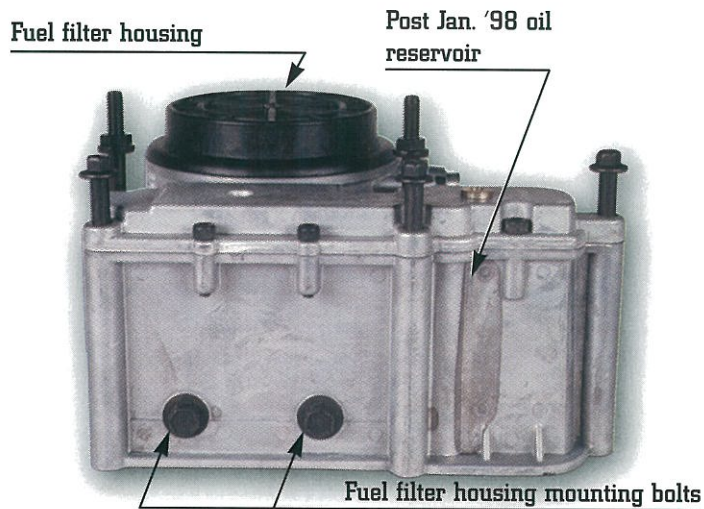

Oil Reservoir

- The new reservoir has the fuel filter assembly mounted to it via two bolts that pass through the housing.

Note: These bolts are not open to oil and must be removed for removal and installation of fuel filter assembly. In-chassis fuel filter assembly removal does not require reservoir removal.

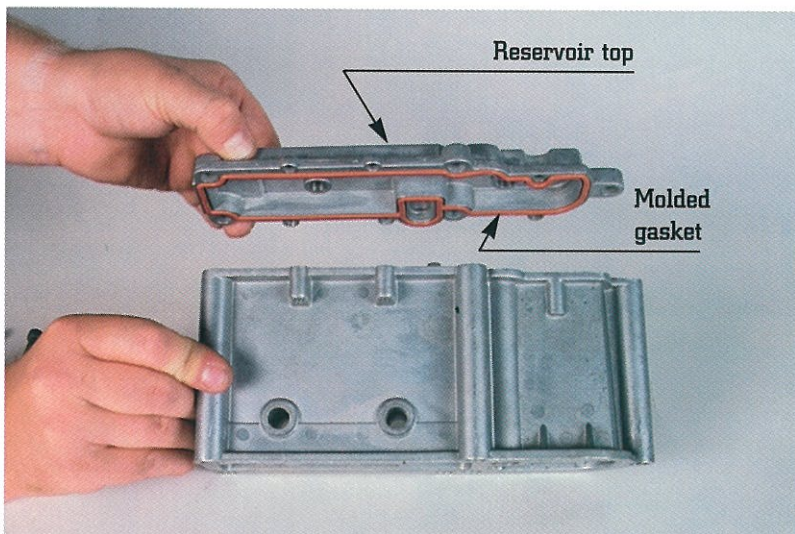

- The oil reservoir is now a two-piece design which allows for reservoir cleaning when required, such as during an engine overhaul.
- The reservoir top is attached by six bolts and is sealed by a one piece molded silicone gasket.

FUEL CHARGING SYSTEM

Fuel Filter

- The fuel filter continues to incorporate a water separator and drain, while supplying fuel to both cylinder heads.

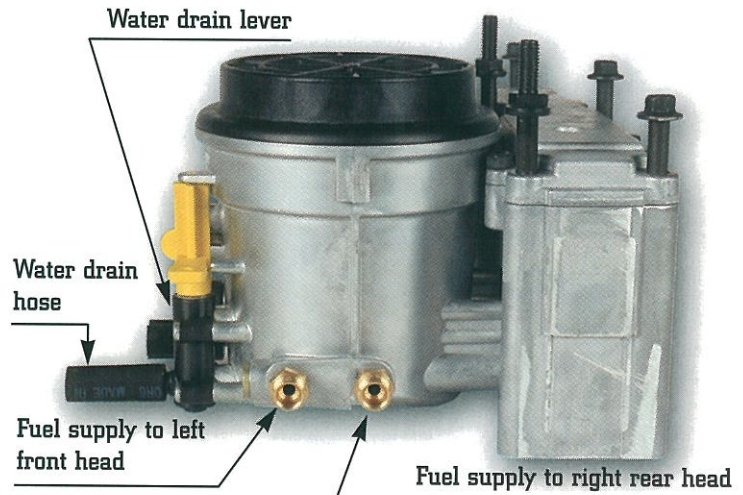

Fuel Filter

- The fuel filter assembly is equipped with a heater to warm fuel to allow it to pass through the filter element in cold ambient temperatures.
- The fuel heater enables at temperatures less than 45° F (7° C) and disables at 75° F (24° C).

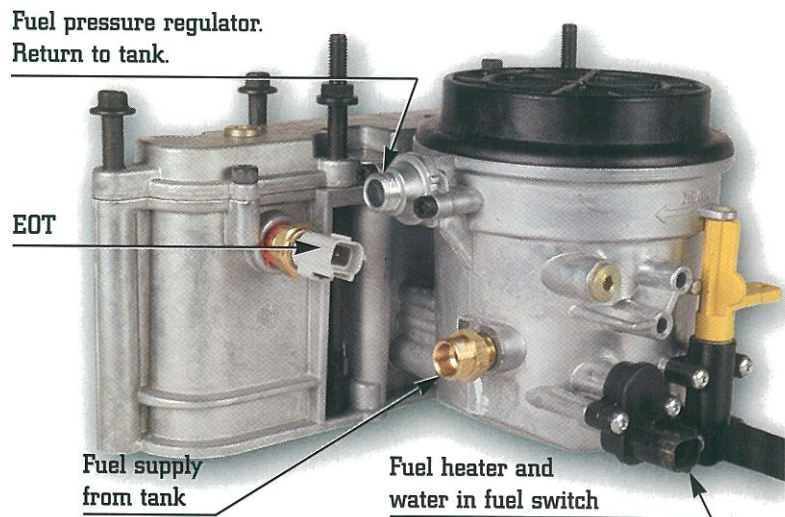

Fuel Pressure Regulator

- Fuel is returned to the tank via a fuel pressure regulator and fuel return line.
- When reinstalling regulator, tighten bolts to **50–70 lbf/in (5.6–7.9 Nm)**.
- Fuel pressure is regulated to a **minimum of 30 psi** independent of engine speed.
- Spool and spring are serviceable (not shown).

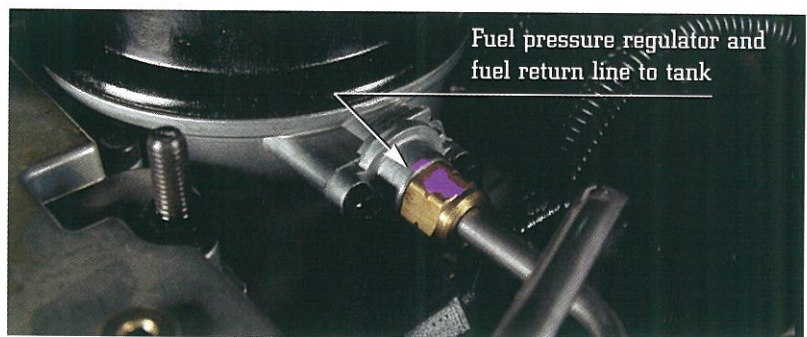

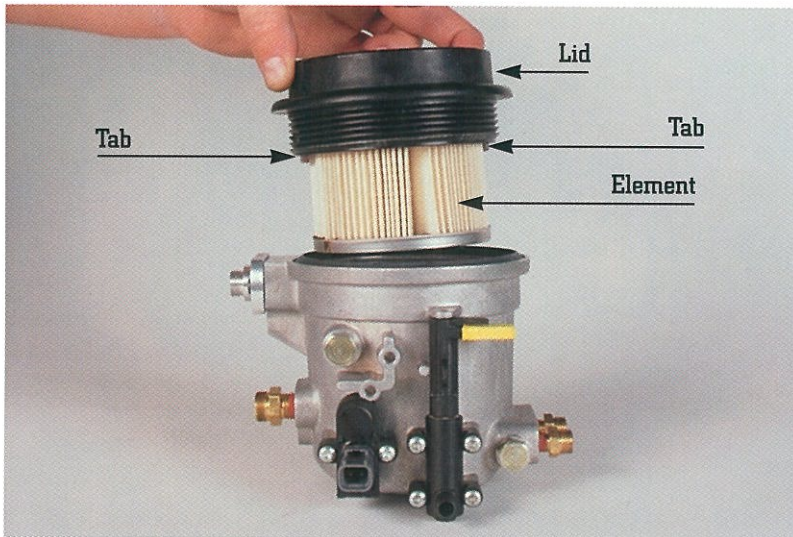

Fuel Filter Service

Fuel Filter Removal

- Loosen the filter lid with a standard oil filter wrench.
- To release fuel filter, depress tabs on side of filter.
- A **dual element fuel filter** will be released during the **1999 model year**.
- **Note:** The fuel filter element is smaller than previous DIT engines and a correct filter element is required in the housing for fuel to flow to the injectors.

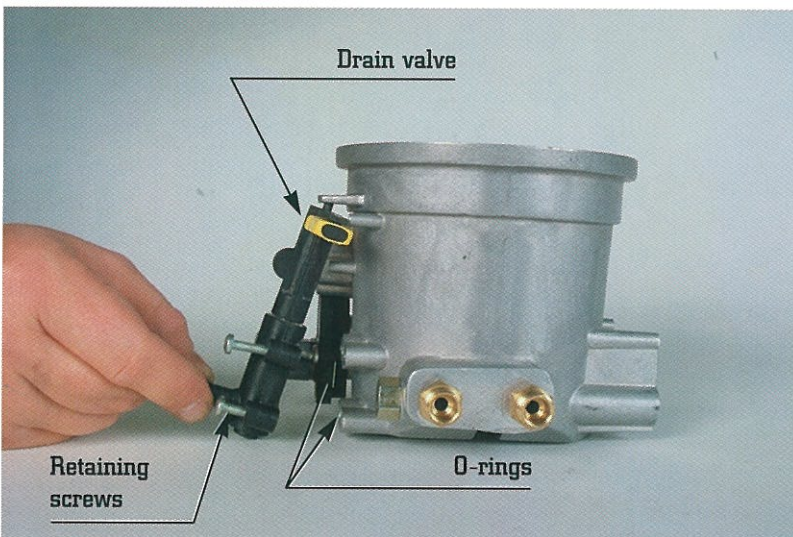

Fuel/Water Drain Removal

- For service, all parts of the assembly are available separately.
- To remove the fuel drain, remove the four retaining screws, tilt the drain away from the housing and pull downward.
- When servicing, tighten retaining screws to **20–25 lbf/in (2.3–2.8 Nm)**.

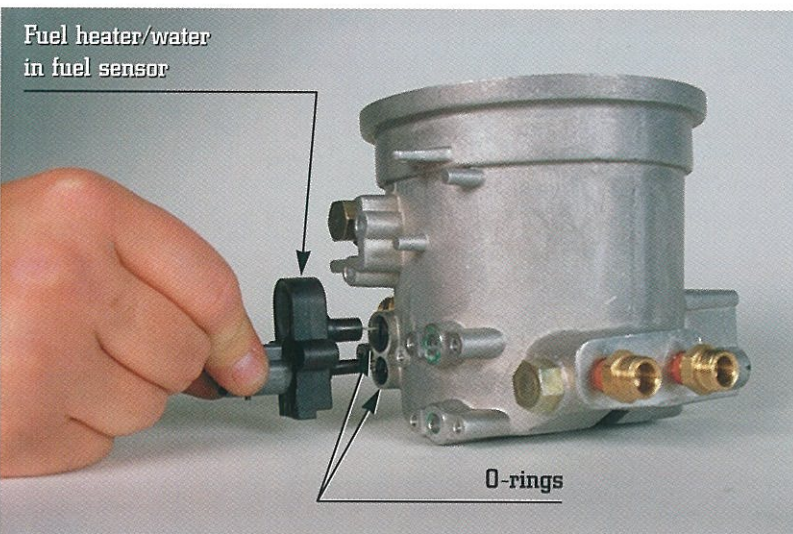

Fuel Heater/Water in Fuel Sensor Removal

- The fuel heater connector and water in fuel sensor are combined in one unit.
- To remove heater/sensor remove the two retaining screws and pull away from housing far enough to disconnect the wire going to the heating element.
- When servicing, tighten retaining screws to **20–25 lbf/in (2.3–2.8 Nm)**.

FUEL CHARGING SYSTEM

Fuel Heater Service

- To remove the fuel heater, first remove the heater/sensor as shown previously.
- Then remove the two screws that hold down the fuel heating element.
- When replacing the element, tighten retaining screws to **20–25 lbf/in (2.3–2.8 Nm)**.

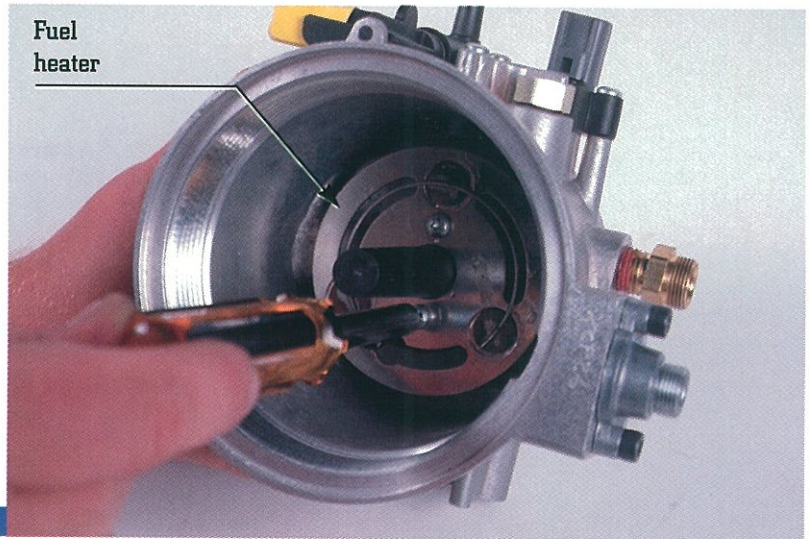

Fuel Filter Standpipe Service

- To remove the fuel standpipe, first remove the fuel heater element as shown above.
- Then pull the standpipe straight out.
- When installing, be sure to install spring and valve.

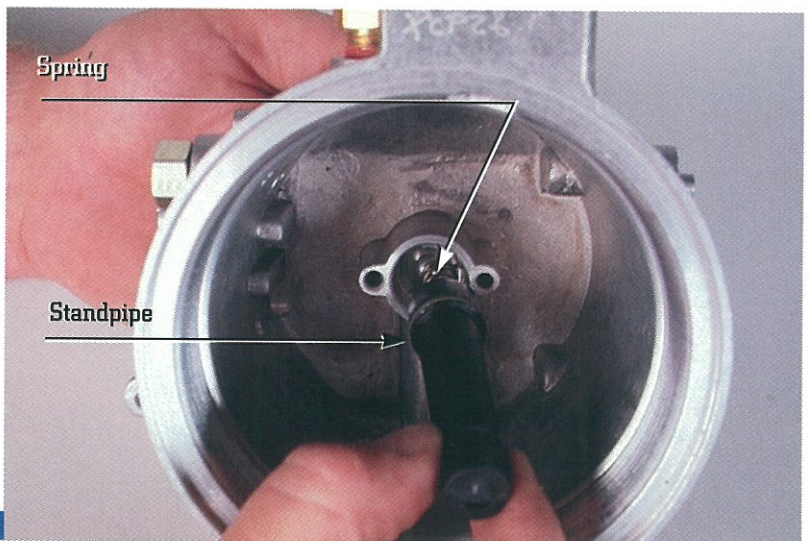

Fuel Filter Service Parts

- The fuel filter assembly is shown here completely disassembled.

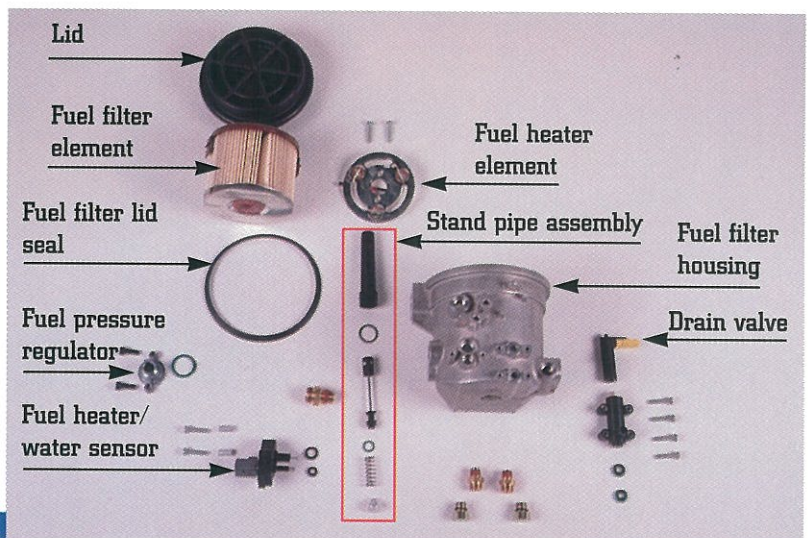

FUEL CHARGING SYSTEM

Fuel filter to cylinder head fuel supply lines

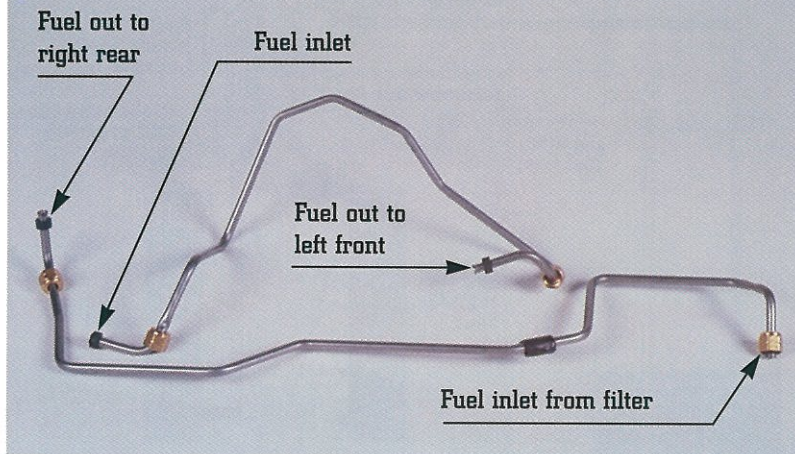

Fuel filter to chassis connections

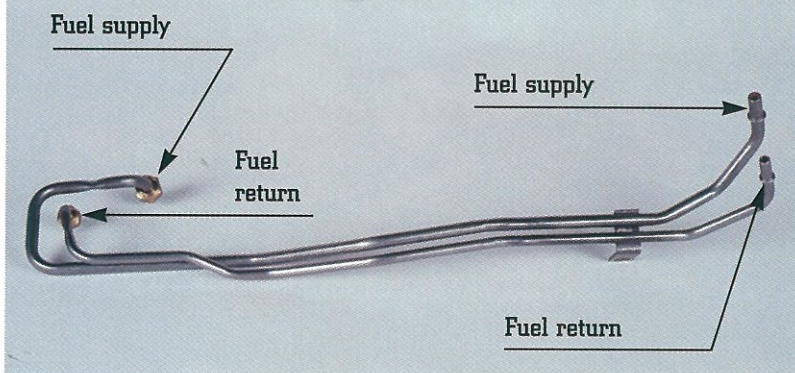

Fuel Supply System

- No return lines are attached to the cylinder heads, only supply lines.
- Excess fuel is returned from the pressure regulator valve to the fuel tank.
- The fuel filter's fuel supply and return lines are a one-piece assembly.

Screen

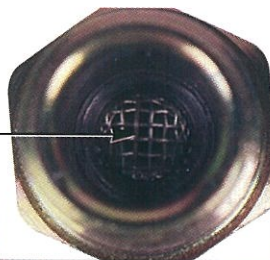

Fuel check valve

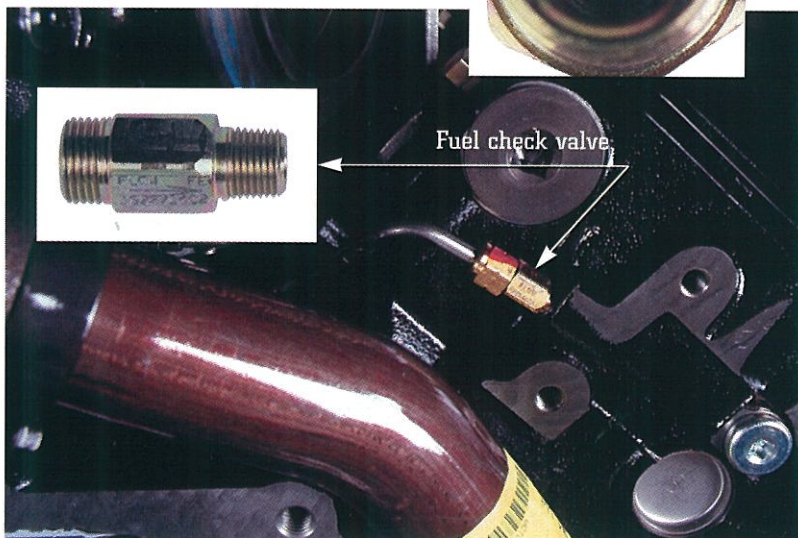

Fuel Check Valve

- The new fuel system incorporates a fuel inlet check valve in the fuel supply fitting to each cylinder head.
- The check valve insures that there is a constant and steady fuel pressure in the head for fuel delivery.
- If fuel pressure is low in one head and normal in the other then inspect the check valve for debris; if no debris is found then replace the valve in the head that exhibits low pressure.
- A screen in the valve is used to stop debris from entering the valve.

FUEL CHARGING SYSTEM

Fuel Supply System

Fuel is supplied to the fuel filter by an electric pump. The fuel filter is pressure regulated. Excess fuel is returned from the fuel filter through the pressure regulator valve, to the fuel tank. Filtered fuel is delivered to the cylinder heads where it enters through check valves. No fuel return from the cylinder heads exists.

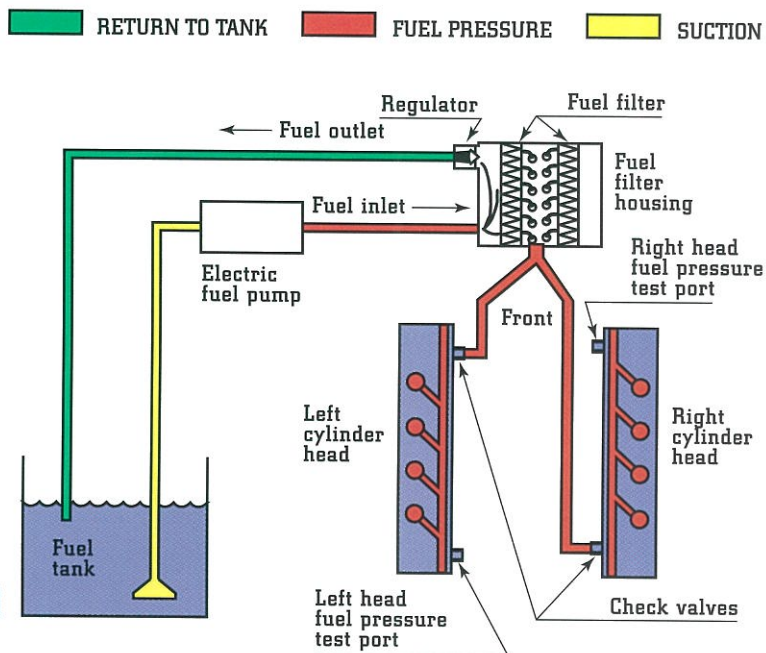

Fuel Pressure Check in Right Head

- To check fuel pressure in the right head install a fuel pressure gauge in the plugged passage at the end of the head opposite the fuel supply line.
- Fuel pressure should not drop below **30 psi**. It is not uncommon to see fuel pressures as high as 80 psi.
- On Econoline, the left head should be checked first. The alternator and bracket must be removed to gain access to the fuel pressure fitting on the right head.

Fuel Pressure Check in Left Head

- To check pressure in the left head install a fuel pressure gauge in the rear of the head near the turbocharger.
- Fuel pressure should not drop below **30 psi**.

Note: When routing lines, be sure to route them away from hot or moving parts.

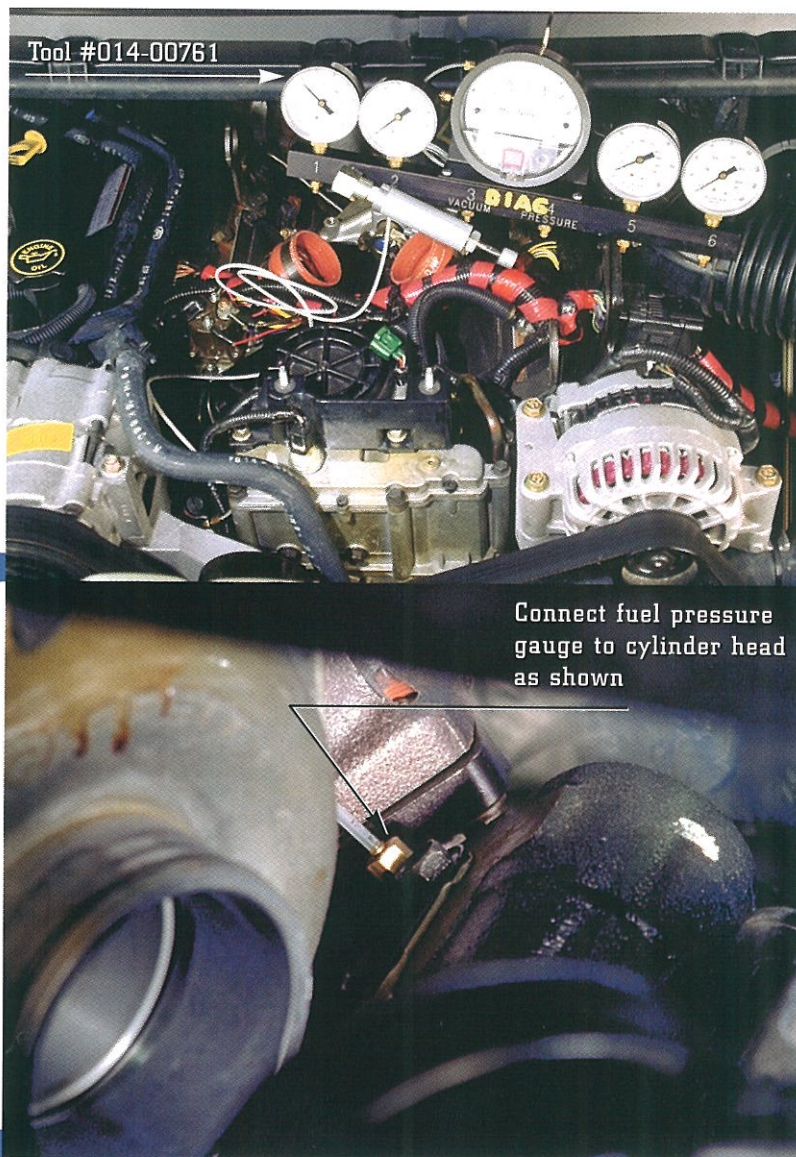

FUEL CHARGING SYSTEM

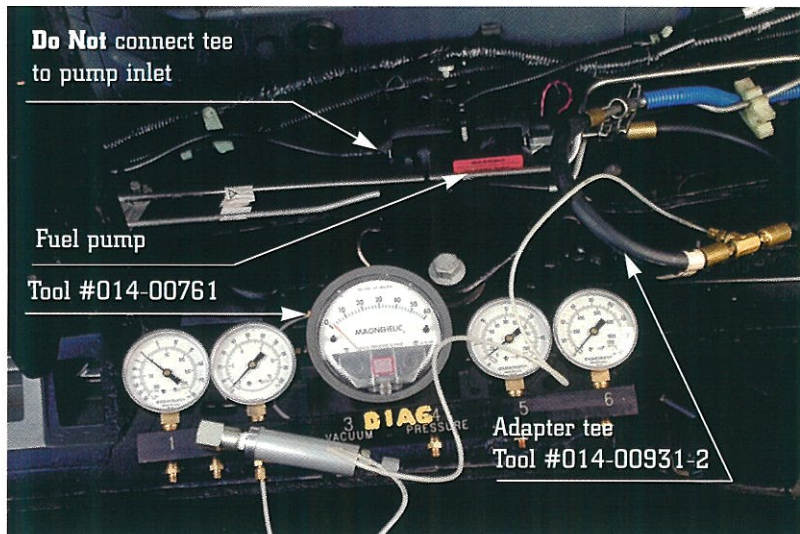

Fuel Pressure Check at Fuel Pump

- Voltage at the fuel pump should be checked to insure that the pump is being powered by the PCM.
- If there is no voltage at the pump the inertia switch, located behind the left hand kick panel, might have been tripped.
- To check fuel pressure at the pump install the fuel pressure adapter tee (Tool #014-00931-2) and install a fuel pressure gauge (Tool #014-00761).

High pressure oil line snap to connect fittings.

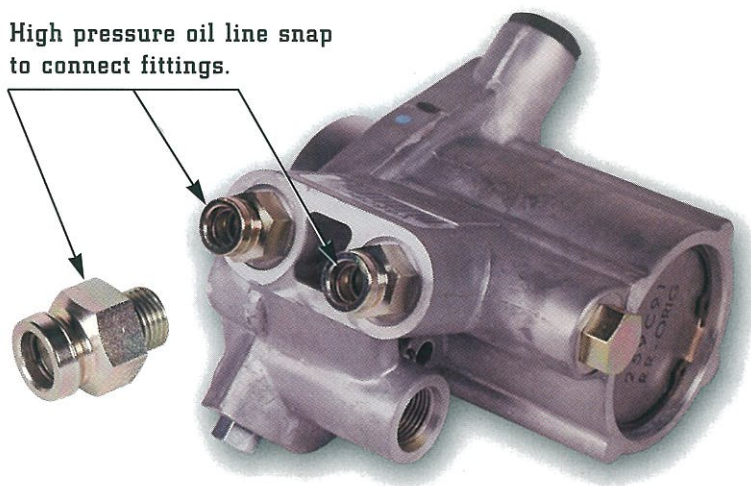

High Pressure Oil Line Snap to Connect Fittings

- The fittings allow the high pressure oil lines to be connected to the high pressure pump and heads simply by pushing them into place.

Note: Whenever high pressure system is opened, air enters the system and the vehicle needs to be driven to remove the air.

Snap to connect high pressure lines

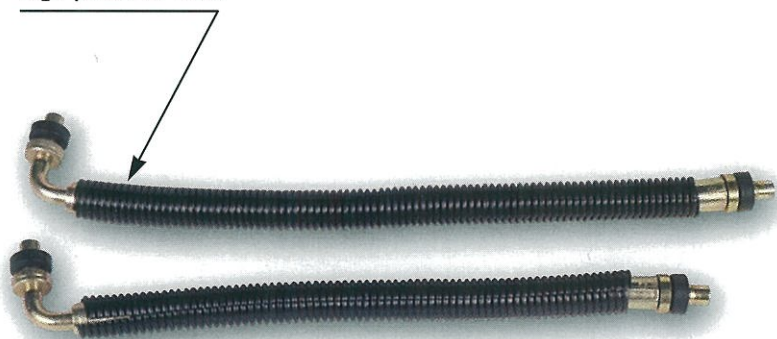

High Pressure Oil Lines

Note: Push the lines into the fittings until you hear/feel the snap ring “grab” the line. Insure connection by pulling on the line.

- Hoses which have been specifically designed to withstand the high pressures (up to 3000 psi) and temperature differentials are used to direct the high pressure oil to the oil galleries in the heads.

FUEL CHARGING SYSTEM

Disconnect Tool

- To release line from fitting:
While firmly pushing the line **straight into** the fitting with one hand, insert the tool behind the black release sleeve and gently pull on the line.
- The tool part number is **303-625**.

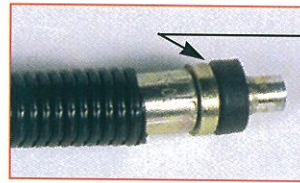

Insert disconnect
tool here to release

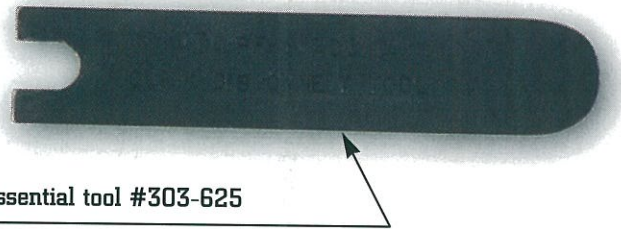

Essential tool #303-625

Injection Control Pressure Block Off Tool

- The block off tools are also of a snap to connect style so that they can be connected to the high pressure oil lines on the engines.
- The tool part number for the block off plug is **303-628** and the ICP adapter is **303-627**.
- These tools are necessary to accurately diagnose the ICP system during hard start/no start diagnosis.

ICP Sensor

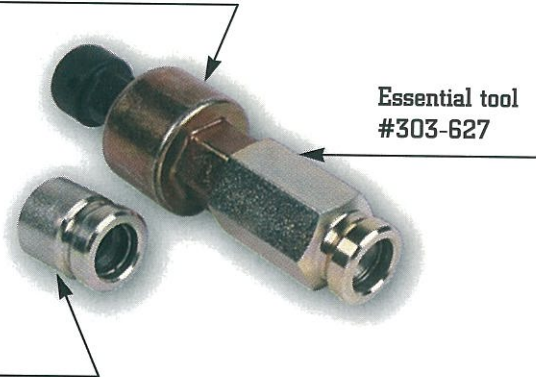

Essential tool
#303-627

Essential
tool #303-628

New MAT Sensor

Revised MAP Sensor

Revised CMP Sensor

Relocated EBP Sensor

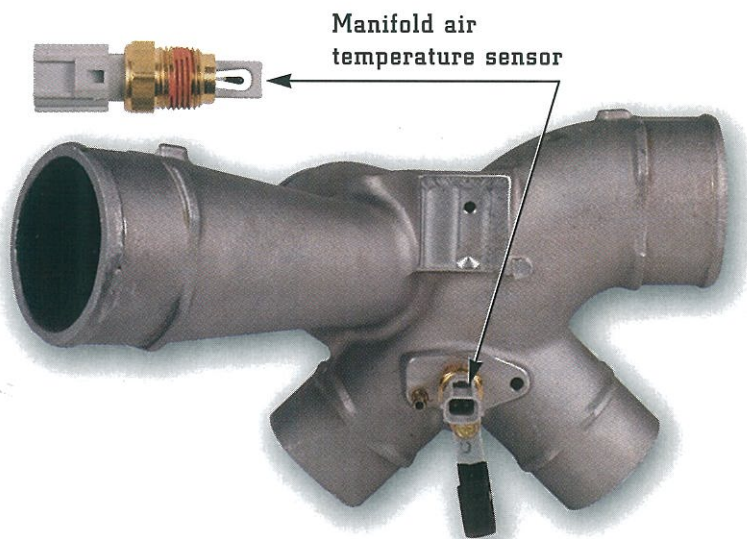

Manifold Air Temp Sensor "F" Series Only

- The MAT sensor is used to control fuel and timing when intake air is cold and adjusts as air temperatures warm up.

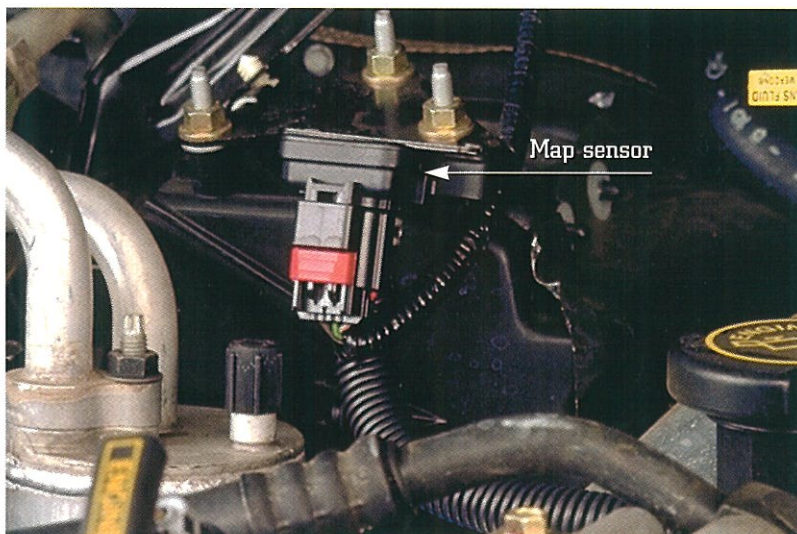

Manifold Absolute Pressure Sensor

- The MAP sensor now sends an analog signal to the PCM instead of the digital signal previously used.
- The sensor is mounted to the heater and air conditioner plenum on the passenger side of the engine compartment.

NEW AND REVISED SENSORS

Camshaft Position Sensor

- The camshaft position sensor circuitry has been updated to be less sensitive of clearance to the trigger wheel.
- The part number suffix on this sensor is **C93**.
- The engine serial number break for this sensor is **623916**.
- See CAMP sensor usage chart on page 45 for information regarding different CAMP sensors and their identification.

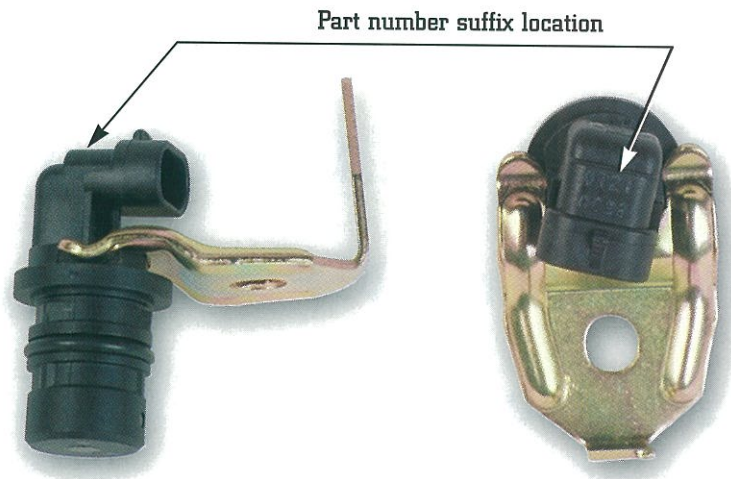

Exhaust Back Pressure Sensor

- The exhaust back pressure sensor has been relocated to the front of the oil reservoir.
- The tube has been redesigned to accommodate the new sensor location.

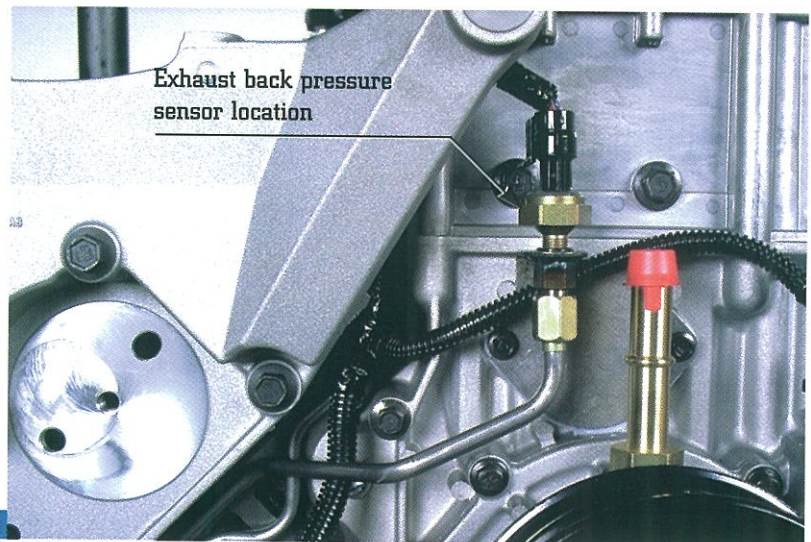

7.3 DIT POWER STROKE SPECIAL TORQUE DATA

COMPONENT	STANDARD	METRIC	
Turbocharger Mounting Bolts (to pedestal)	35 lbf-ft	47.5 Nm	
Turbocharger Exhaust Inlet Adapter V-band Clamp	100 lbf-in	11.3 Nm	
Turbocharger Compressor Housing (to center section)	11–14 lbf-ft	15–17 Nm	
Turbocharger Turbine Housing (to center section)	15–18 lbf-ft	22 Nm	
Turbocharger EBP Valve Housing (M6 bolt) (to turbine housing)	60–80 lbf-in	6.8–9 Nm	
Air Inlet Covers (M8) (Intake manifolds)	18 lbf-ft	24 Nm	
Exhaust Manifold (to cylinder head) (M10)*	45 lbf-ft	61 Nm	
Exhaust Manifold Flanges (to up pipe) (M8)*	18 lbf-ft	24 Nm	
Exhaust Adapter Flange (to up pipe) (M8)*	18 lbf-ft	24 Nm	
Turbine Outlet Clamp	50 lbf-in	5.6 Nm	
Cylinder Head Bolt Torque	Step 1	65 lbf-ft	88 Nm
	Step 2	85 lbf-ft	115 Nm
	Step 3	95 lbf-ft	129 Nm
Fuel Injector Hold Down Clamp Mounting Bolt	120 lbf-in	14 Nm	
Fuel Injector Hold Down Clamp Shoulder Bolt	120 lbf-in	14 Nm	
Fuel Rail End Plug	97 lbf-in	11 Nm	
Glow Plug	124 lbf-in	14 Nm	
Injector Oil Deflector Mounting Bolt	106 lbf-in	12 Nm	
Oil Rail Drain Plug	53 lbf-in	6 Nm	
Oil Rail End Plug **	59 lbf-ft	80 Nm	
Valve Cover Mounting Bolt	97 lbf-in	11 Nm	
Oil Pan Drain Plug	28 lbf-ft	38 Nm	
Crankshaft Vibration Dampener Bolt	212 lbf-ft	287 Nm	
Oil Level Gauge Tube Adapter Nut	24 lbf-ft	33 Nm	
Front Cover Mounting Bolts	15 lbf-ft	20 Nm	
Water Pump Mounting Bolts	15 lbf-ft	20 Nm	
Oil Pick-up Tube Flange Bolts	18 lbf-ft	24 Nm	
Connecting Rod Nuts	(first step)	52 lbf-ft	71 Nm
	(final)	80 lbf-ft	108 Nm
Water Outlet Tube Mounting Bolt	15 lbf-ft	20 Nm	
Injection Control Pressure Sensor (ICP)**	22 lbf-ft	30 Nm	
Flywheel Mounting Bolts	89 lbf-ft	121 Nm	
Main Bearing Cap Bolts	(first step)	75 lbf-ft	102 Nm
	(final)	95 lbf-ft	129 Nm
Rear Cover Mounting Bolts	15 lbf-ft	20 Nm	
High Pressure Pump Gear Bolt	95 lbf-ft	129 Nm	
Injector Pressure Control Valve Body	35 lbf-ft	47 Nm	
Injector Pressure Control Valve Nut	55 lbf-in	6 Nm	
Filter Drain Valve	20–25 lbf-in	2.3–2.8 Nm	
Reservoir Lid Screws	75–95 lbf-in	8.5–10.7 Nm	

To insure proper torque, all threads must be cleaned and lightly lubricated.

* Apply "Never Seez" compound to threads of bolts prior to assembly.

** Threads of apply Loctite #277 to bolts prior to assembly.

Changes or new information is in bold type.



7.3L DIT *Power Stroke* Diagnostic Information

Diagnostic Guides, Schematics, and Fault Code

**Lists for all model years are provided in the back
of this publication.**

7.3L DIT ANTHOLOGY

Fuel filter restriction sensor

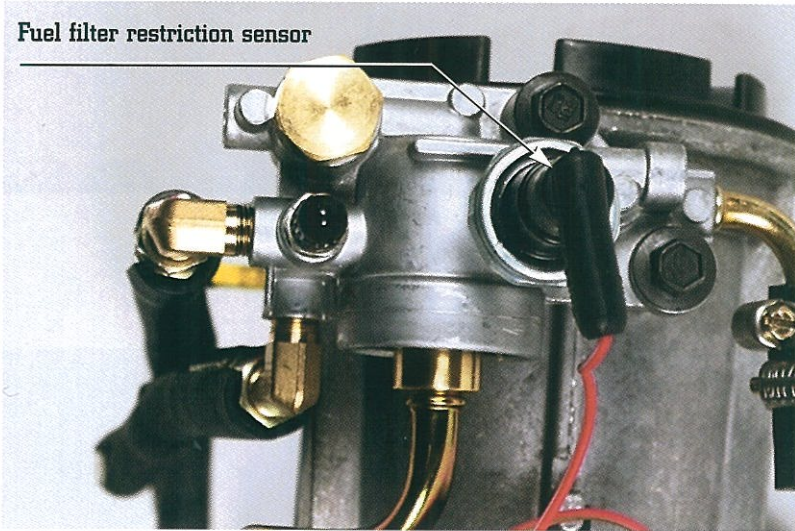

Pre January 1998 Fuel Filter Service

Note: All individual parts are available for repair as necessary.

Fuel Filter Restriction Sensor Removal and Installation

- To remove the fuel filter restriction sensor first disconnect the one wire connector.
- Then use a 1¹/₁₆" sending unit socket and remove the sensor in a counter clockwise direction.
- To reinstall reverse steps and torque sensor to **35–45 lbf/in (4–5 Nm)**.

Fuel Pressure Regulator Housing Removal and Installation

- Remove the two (2) 10mm regulator retaining cap screws.
- Separate the regulator housing from the filter housing by approximately 1/4" to enable the fuel passage shoulder to properly clear the housing.
- Slide the regulator housing upward to disengage it from the metal fuel line.
- To reinstall slide regulator housing down to reengage it with the metal fuel line.
- Align the regulator housing so that the passage shoulder fits into the fuel filter housing.
- Reinstall the two (2) 10mm cap screws and torque to **100–120 lbf/in (11.3–13.6 Nm)**.
- Reconnect the fuel pressure sensor one wire connector.

Regulator housing

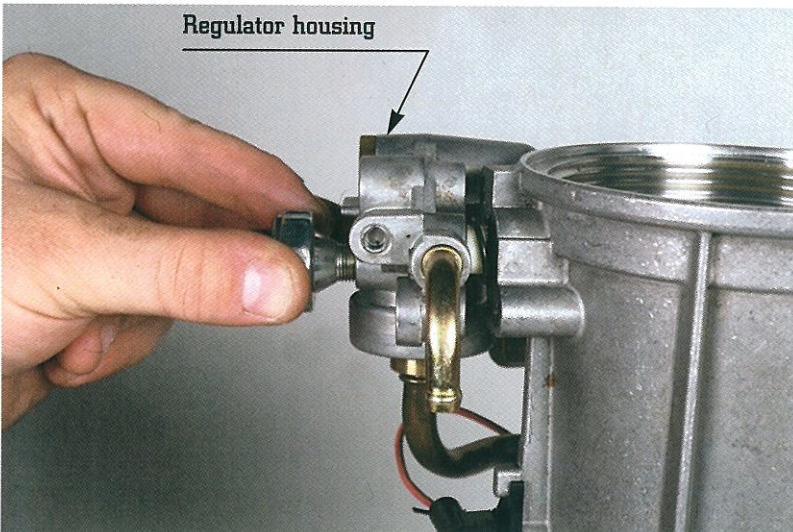

7.3L DIT ANTHOLOGY

Pre January 1998 Fuel Filter Service

Water Sensor Removal and Installation

- Disconnect the one wire connector.
- Use a 9/16" wrench and remove sensor.
- To reinstall reverse steps and torque to 18–24 lbf/in (2–2.7 Nm)

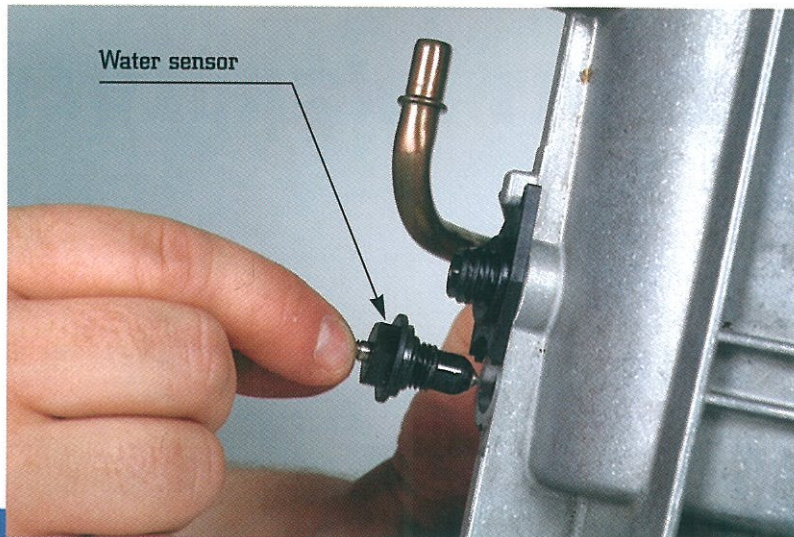

Fuel Heater Connector Removal and Installation

Note: Water sensor must be removed
before removing fuel heater connector.

- Disconnect the external one wire connector.
- Rotate the fuel heater connector clockwise until it clears the locking tab.
- Pull connector out and disconnect the internal one wire connector.
- To reinstall reverse steps.

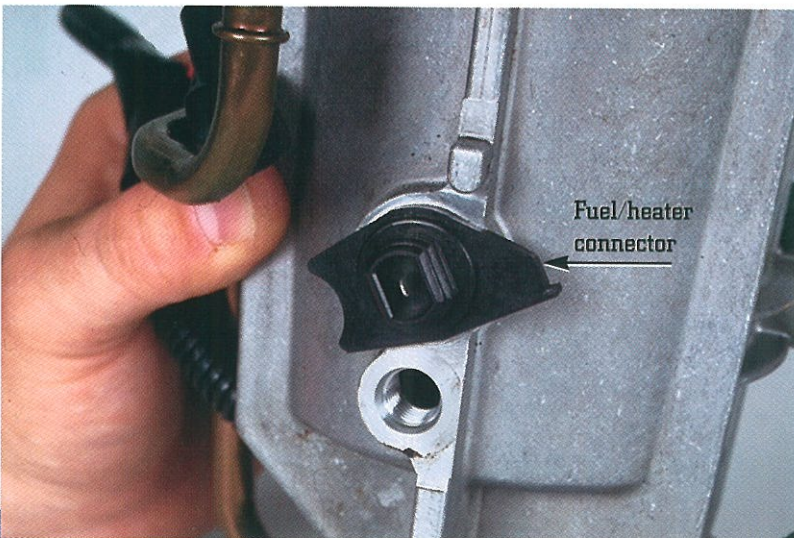
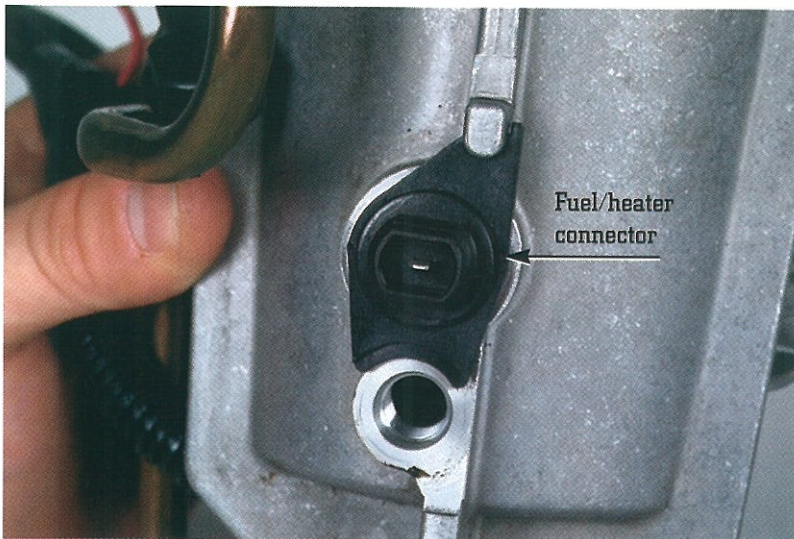

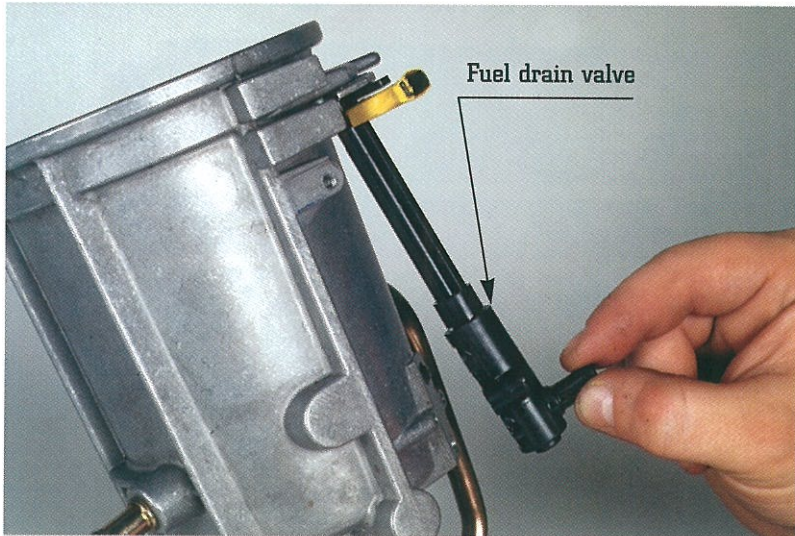

Pre January 1998 Fuel Filter Service

Fuel and Water Drain Valve Removal and Installation

- Remove the two phillips head retaining screws
- Tilt drain valve away from the filter housing, note the location of the o-rings.
- Pull valve downward to separate from housing.
- To reinstall drain valve reverse steps and tighten screws to **20–25 lbf/in (2.3–2.8 Nm)**.

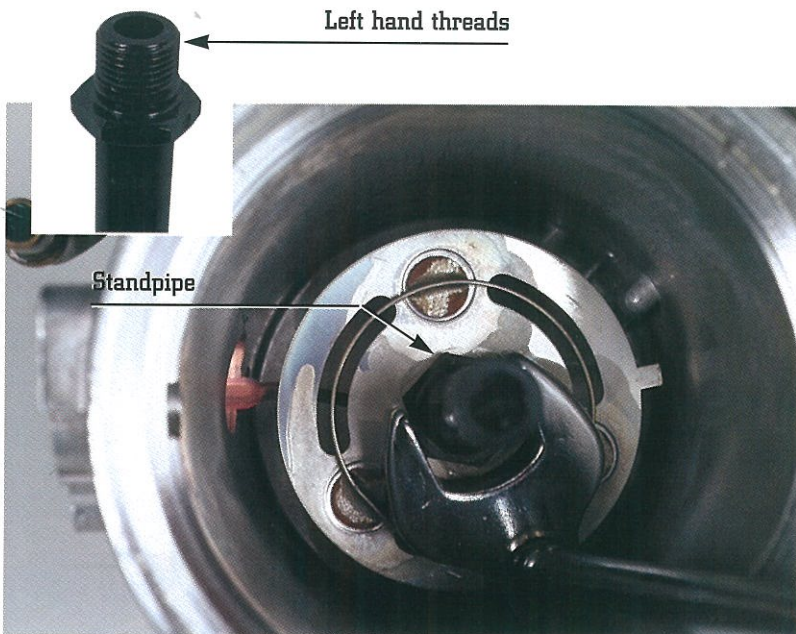

Stand Pipe and Heating Element Removal and Installation

- Drain fuel from filter housing.
- Remove fuel filter lid and filter element.
- **Note: Stand pipe is plastic and has left hand threads.**
- Using a 7/8" crows foot remove stand pipe by rotating it in a clockwise direction.
- Disconnect the internal one wire connection at the fuel heater connector.
- Remove fuel heating element.
- To reinstall, reverse steps and tighten standpipe to **120 lbf/in (13.6 Nm)**.

7.3L DIT ANTHOLOGY

Crankcase

- The crankcase was redesigned starting with engine serial number **375549** with thicker valley walls to increase stiffness to the assembly which reduces radiated engine combustion noise.
- The crankcase was also modified in the tappet shelf area.

Pre 1997 Model Year

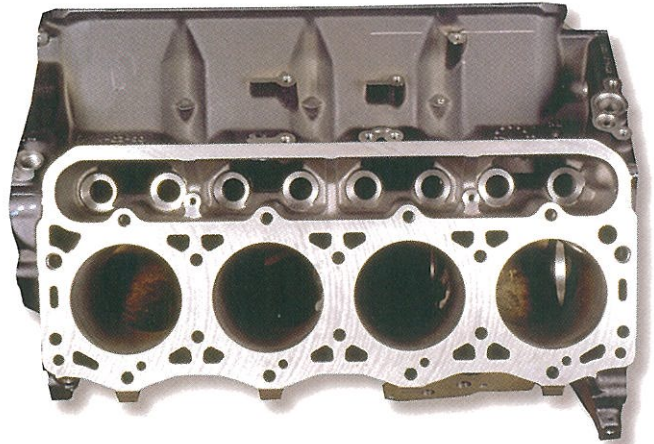

1997 Model Year

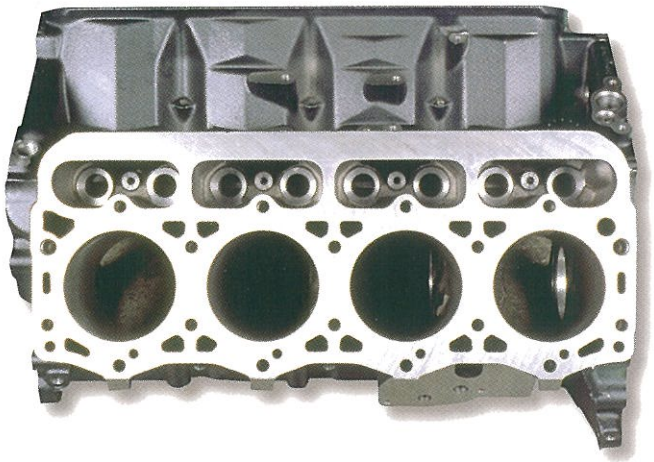

Valve Train

- The valve train was redesigned to replace the cam follower guides and retainer to redesigned cam follower guide assemblies which bolt directly into the crankcase to hold the follower in place.
- The redesigned roller follower guide assemblies are now held in place with a capscrew for each pair of tappets which has led to the elimination of the roller follower guide retainer.
- This change occurred at engine serial number **375549**.

Pre 1997 Model Year

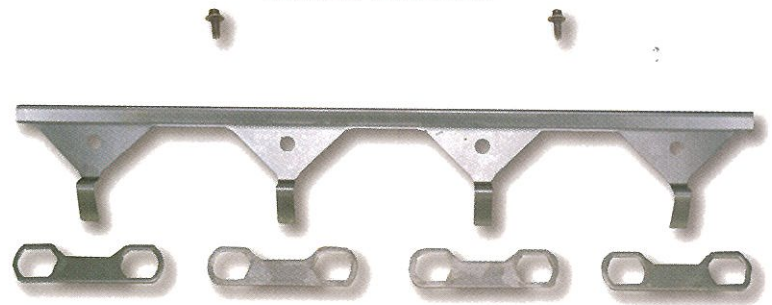

1997 Model Year



Pre 1997 Model Year

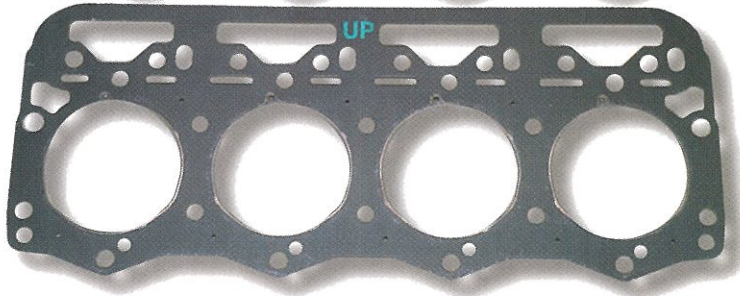

1997 Model Year

Cylinder Head Gasket

- Due to the change in the crankcase and valve train the cylinder head gasket was also changed.
- The redesigned cylinder head gasket provides individual holes for each push rod which will guide the push rod ball seat into the lifter.
- This redesigned cylinder head gasket can be used on previous engines.



1997 Model Year

Pre 1997 Model Year

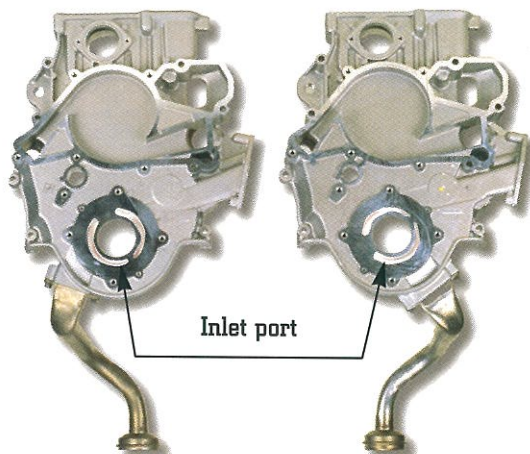

Front Cover

- A deaeration valve was inserted in the front cover beginning with engine serial number **201681** through engine serial number **375549**.
- The front cover was redesigned starting with engine serial number **375549** to help keep the oil pump primed for initial start up.
- To accommodate this change the pump inlet port was rotated 90° which moved the pickup tube from the left to the right.
- The front oil cooler header gasket was also redesigned because of the change to the front cover.
- The front cover has been modified for the updated reservoir to front cover gasket and passages have been cast and drilled into the front cover to incorporate the standpipe.
- The engine serial number that the standpipe was incorporated is **201681**.

7.3L DIT ANTHOLOGY

Oil Reservoir for the High Pressure pump

As of engine serial number **187100** the reservoir has been cast and drilled to include the standpipe and is drilled, tapped and spotfaced to use both a straight thread, o ring sealed engine oil pressure sensor and inspection plug as sealing enhancements.

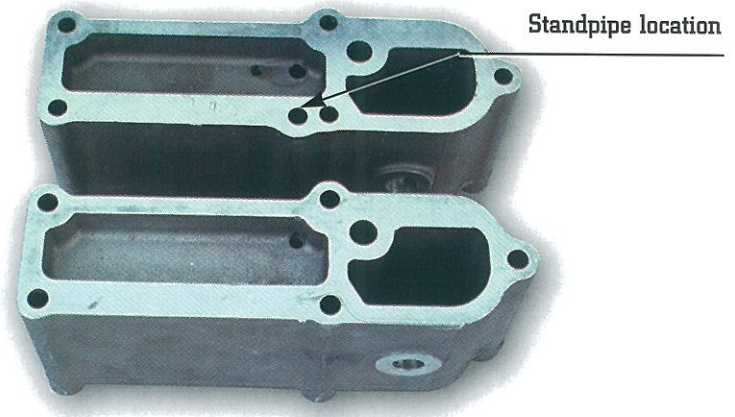
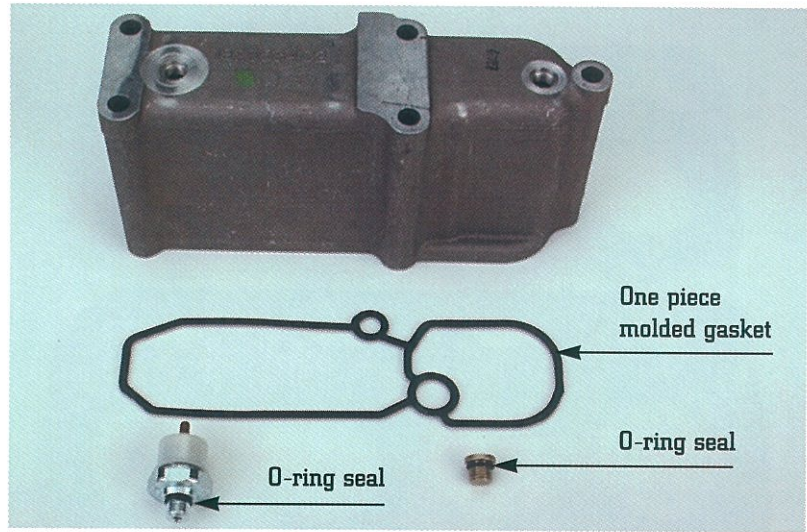

Oil Pan

Due to the relocation of the pickup tube the oil pan baffle was redesigned to allow the pickup tube to pass through it to the bottom of the pan. This was done as of engine serial number **375549**.

1997
Model year



Pre 1997
Model year



Fuel Injectors Part Numbers

	Navistar Injector Part Number		
	On top of injector solenoid	On gold screw replacement units	Converted to Ford number
FEDERAL	1816187C3	1821836C2	F7TZ9E527 ARM
PRIME	1822803C1	1825125C1	F7TZ9E527 BRM



All '97 "E" series and California "F" series

Federal "F" series 1997 Model



Injectors

California calibration, model year 1996–1997, utilized a *"Split Shot"* injector that in conjunction with the proper PCM calibration provides rate shaping capabilities. Our rate shaping provides an initial charge of fuel early in the injection cycle, followed by a larger quantity of fuel to complete the injection cycle. During the 1997 model year Econoline utilized the *"Split Shot"* injectors in all Federal and California calibrations.

- Rate shaping of injection provides for a longer duration of the injection process, providing a cleaner, quieter burn.
- Federal "F" Series (49 State and Canada) injectors were unchanged through the 1997 model year

Note: Injector solenoids are now white in color instead of the prior black units. No functional change exists in the solenoids.

Fuel System

- The fuel system has been improved by new fuel supply pipe assembly and banjo fitting. The new fitting on 1997 Econoline and 1997 California "F" series incorporates an accumulator to steady fuel pressure for the *"Split Shot"* injection system.

7.3L DIT ANTHOLOGY

High Pressure Oil Pump

The high pressure pump has had the drain check valve deleted. This brings the variation of high pressure pumps used on the DIT to three. The pumps may be identified by the absence or presence of the anti drain check valve.

- On 1994 1/2 and 1995 model year engines up to serial number **187099**, the initial high pressure pump did have a drain check valve but did not have an edge filter. The edge filter was part of the injection pressure regulator.
- On 1995 model year engines starting with serial number **187100**, up to serial number **201680**, the high pressure pump did have a drain check valve and an integral edge filter. The edge filter was deleted from the injection pressure regulator.
- On 1996 model year engines starting with serial number **201681**, the high pressure pump does not have a drain check valve, but continues to have an integral edge filter.

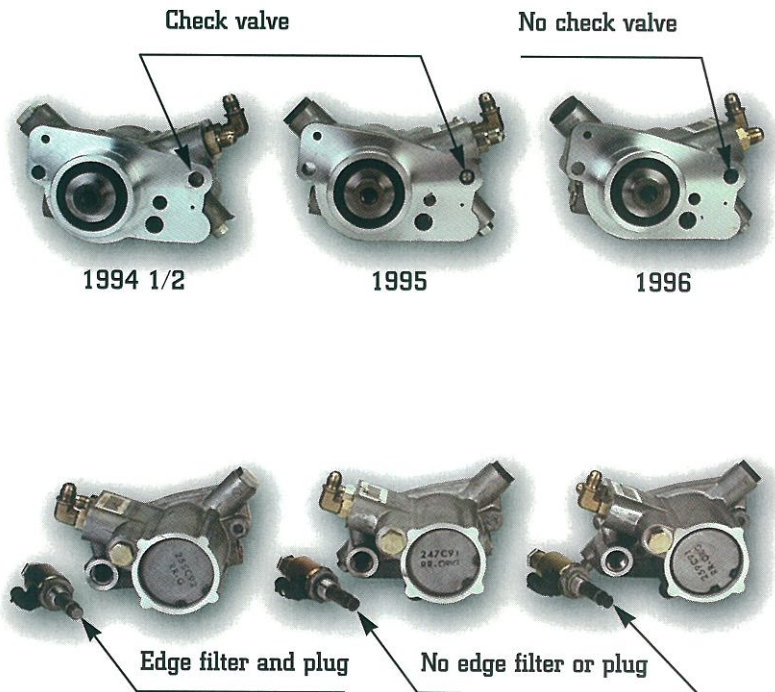

High Pressure Pump Gasket

- The high pressure pump gasket has been modified to seal the standpipe between the pump and front cover.

Note: The correct gasket must be used to prevent internal and external oil leaks.

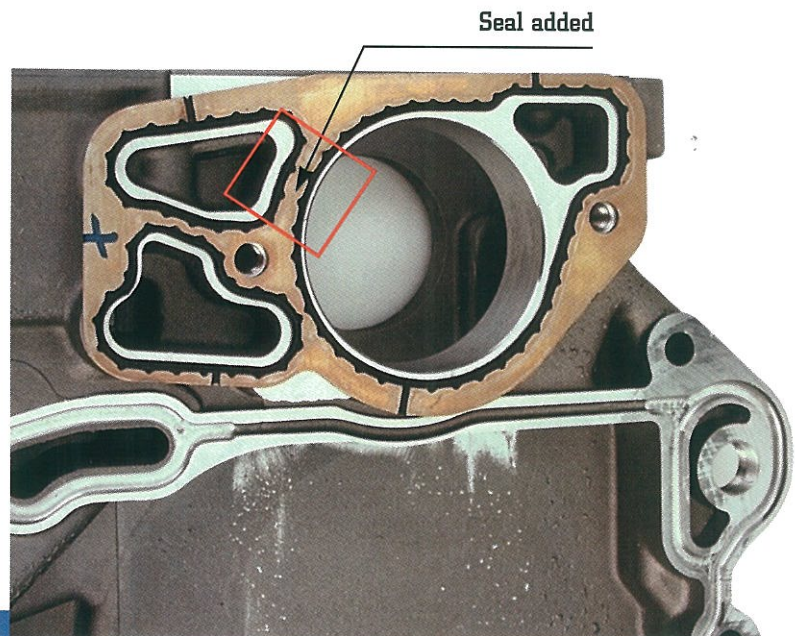

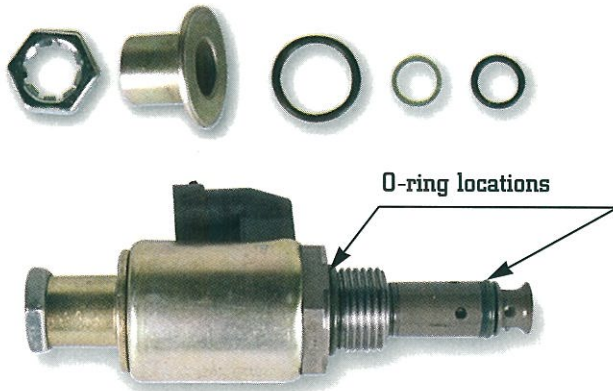

Injection Pressure Regulator (IPR)

- On all engines starting with engine serial number 187100 and above, the injection pressure regulator does not have an edge filter, but the high pressure pump does.

Note: There is now a service package for the IPR o-rings that allow you to replace them separately if needed.

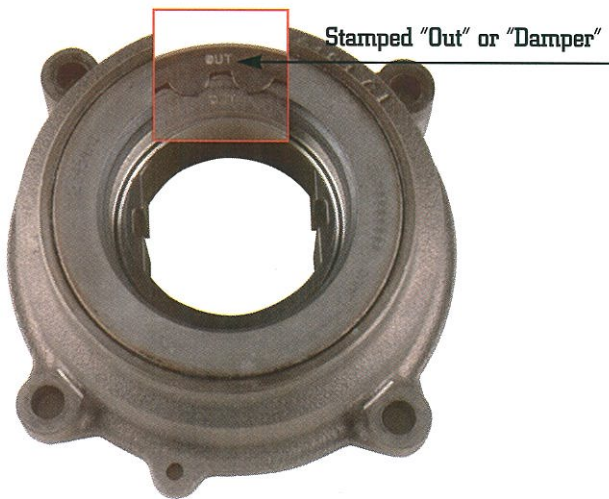

Oil Pump

The engine lube oil pump has been modified to include the words "out" or "damper" on its face, this is to insure that the pump is installed correctly and no damage occurs to the front cover due to incorrect installation.

"F" Series
49 State

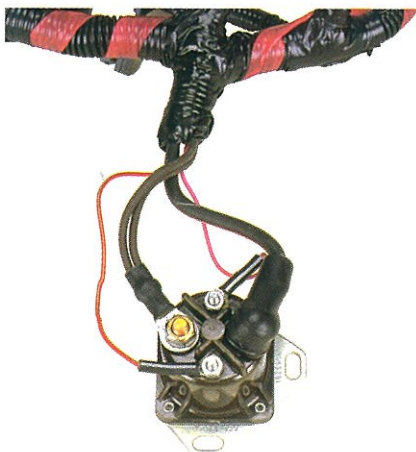

"E" Series and
"F" Series
California

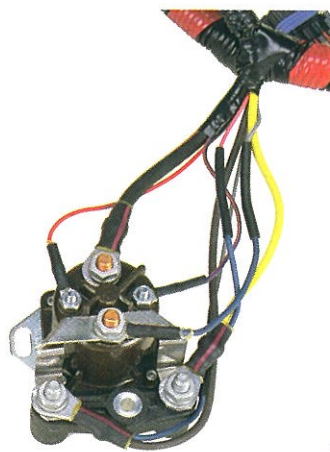

Wiring Harness and Glow Plug Relay

- The wiring harness was redesigned starting with serial number 375549 to incorporate gold plated terminal pins to increase reliability and meet OBD II standards.
- The sensors and connectors that received the gold pins were CMP, EBP, ECT and ICP.
- The UVC harness now incorporates a wire clip instead of plastic tabs to attach to the injectors for improved reliability and ease of removal.
- The redesigned glow plug relay system is not affected by high operating temperatures. This redesign includes a new relay, relay cover, and mounting brackets.
- The 1997 Econoline and 1997 California models also include a new housing post (GPC sensing) in the redesign.

7.3L DIT ANTHOLOGY

Thermostat

- The thermostat, along with being longer to seal the lower bypass seat, opens at a lower coolant temperature, 89° C (192° F) from 96° C (205° F) to allow the engine to operate at lower temperatures.

1996 Model Year



Pre 1996 Model Year

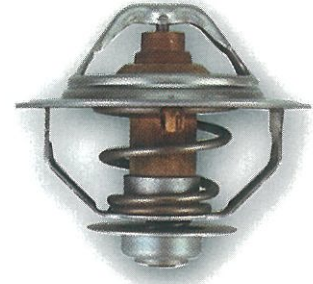

Water Pump

The water pump has evolved since 1994 model year. Currently there are two part numbers to service the Pre January 1998 engines. The F7TZ-8501-ARM pump is to be used on all 1996 and 1997 model year engines with serial numbers starting with **201681** through January 1998 production. The F5TZ-8501 ARM is to be used on all engines from the 1994 model year serial number **000501** through 1995 model year serial number **201681**. The F5 pump comes with a bolt package that is to be used to mount the replacement pump. The F5 pump also incorporates a larger bearing than the 1994 pump, all pumps, new and remanufactured, have an improved silicon carbide seal.

1994 – 1995

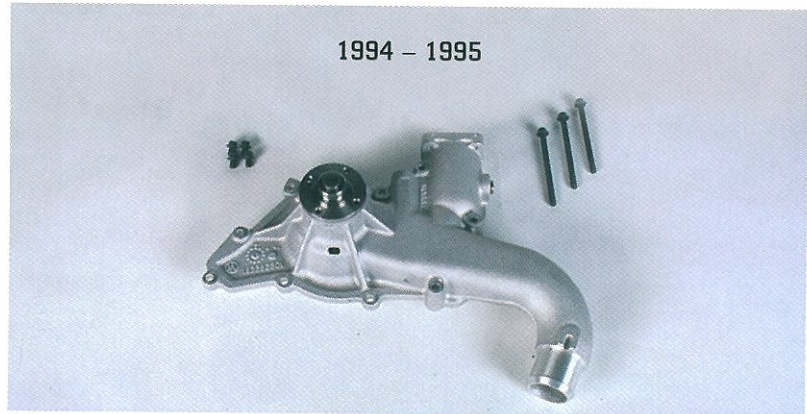

1996 – 1997

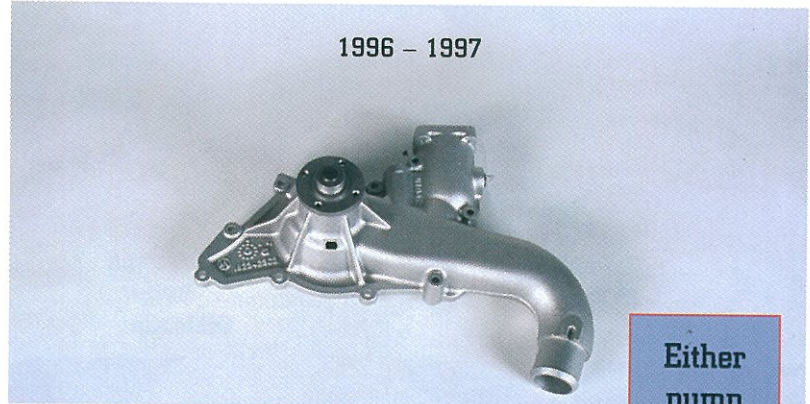

1996 – 1997

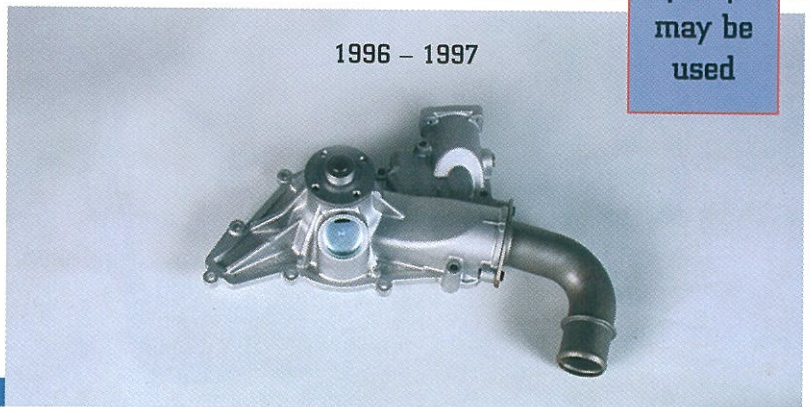

Either pump may be used

Parts Suffix Summary

Suffix	Key Features	Pin Material	Length
C96*	CMP sensor at job1 94.5	Tin Plated	1.152 ±0.006"
C97*		Tin Plated	1.152 ±0.006"
C98*		Tin Plated	1.142 ±0.004"
C99	Improved Circuitry	Tin Plated	1.142 ±0.004"
C91*		Gold Plated	1.152 ±0.006"
C92*		Gold Plated	1.142 ±0.004"
C93	Improved Circuitry	Gold Plated	1.142 ±0.004"

* No longer available as service parts

Part number suffix location

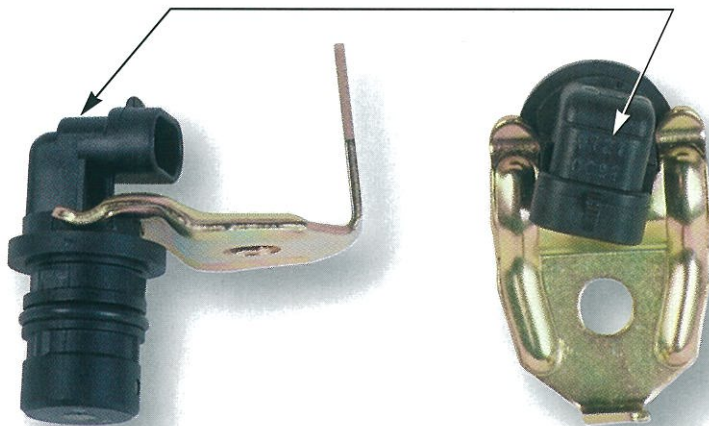

No wear sleeve

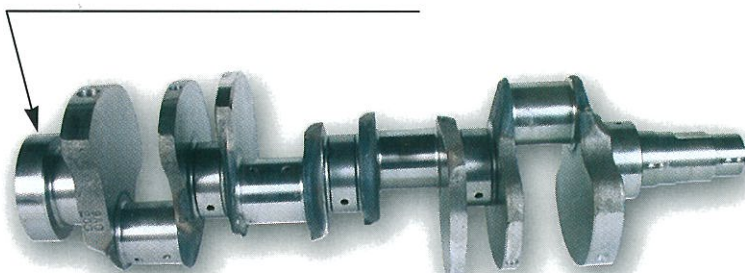

Camshaft Position Sensor (CMP)

- The CMP sensor has also been changed to incorporate gold plated pins. There has also been changes in length and circuitry since 1994. To identify each CMP sensor there is a part number suffix located on the top of the sensor near the sensor wiring connector. The CMP with a part number suffix of **C96** is 1.152" ± 0.006" in length and has tin pins, this sensor was used in engines with serial numbers between **000501** and **033780**. A **C96** sensor should not be installed as a replacement sensor. The sensor with a **C97** suffix is tin plated and 1.152" ± 0.006" in length. This sensor has improved circuitry over the **C96** sensor. The **C98** sensor is identical to the **C97** except for the length, it is 1.142" ±0.004" in length.
- Due to the change in wiring harnesses three new sensors were made with gold pins. The **C91** sensor is 1.152" ± 0.006" in length, which was used in engine serial numbers **375549** through **408253**, and the **C92** is 1.142" ± 0.004" in length, which was used in engine serial numbers **408253** through **623916**. A sensor with a part number suffix of **C93** has gold pins and a length of 1.142" ±0.004", this sensor has improved circuitry over the **C91** and **C92** sensors. The **C93** sensor is being used as of engine serial number **623916**.
- The camshaft position sensor circuitry has been updated to be less sensitive of clearance to the trigger wheel.
- The part number suffix for the gold plated sensor is **C93** and **C99** for the tin plated sensor.

Crankshaft

The crankshaft's rear seal no longer utilizes a wear sleeve on production DIT engines beginning with engine serial number **201681**. The service rear crankshaft seal does utilize a wear sleeve, no change has been made to the service seal package.

Oil Cooler Header Pressure Regulator and Filter Bypass

- As of engine serial number **286299** the oil pressure regulator and the oil filter bypass is held in with a c-clip instead of staking.

Note: Bypass valves should be in place to avoid engine damage.

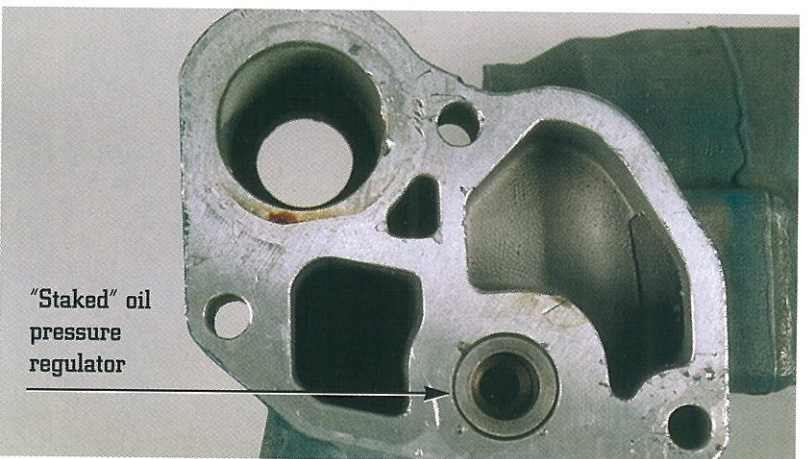
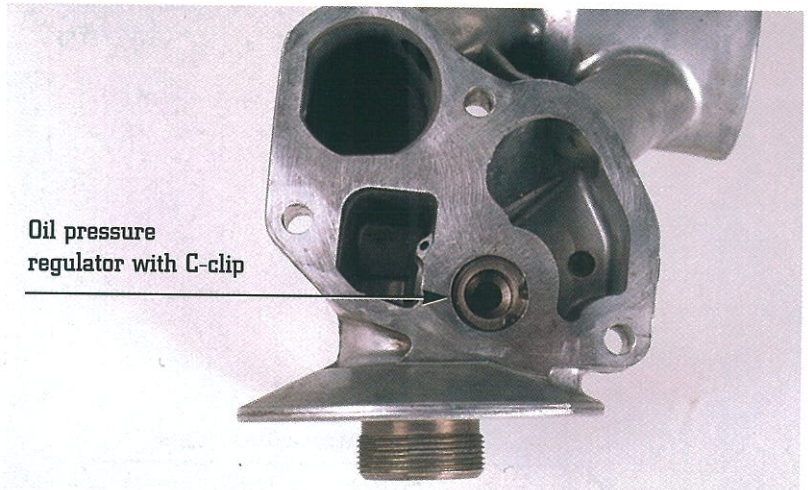
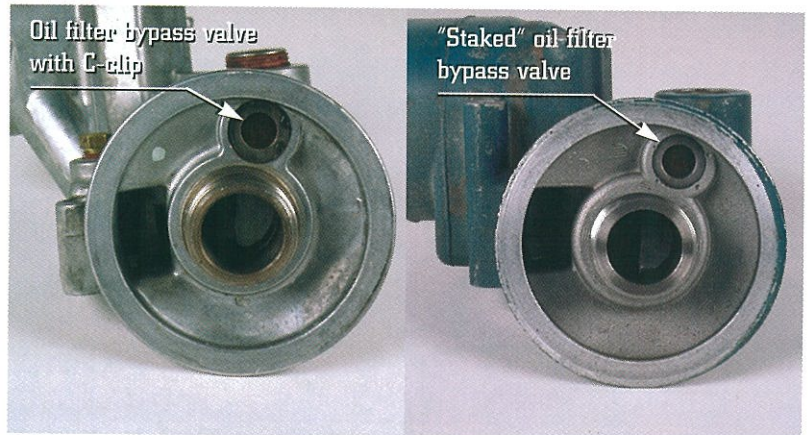



Intake Hoses

The hoses connecting the turbocharger discharge Y pipe to the intake manifolds have been changed as of engine serial number **201681** to delete the humps and may be used interchangeably.



Extra sealant required in these locations



Fleetrite part number CH1824392

Oil Pan Sealing

When resealing the oil pan, make sure that the silicone is applied properly. Extra sealant is required at the ends of the radius' on each end of the pan. Make sure to avoid applying too much sealant to pan rails since it can fall off in the pan and plug the oil pick up tube. Always use dowels (make locally), to locate the pan during installation. Whenever the oil pan is resealed, add a bottle of anti foam concentrate to the oil available at Navistar dealers (P/N CH1824392).

7.3L DIT ANTHOLOGY

Intake Covers

The number of bolts holding the intake covers in place went from eight (8) to ten (10) this change was done at engine serial number 174666.

Intake Cover

- **Ten Bolt Replaces 8 Bolt**
- **Serial Number 174666**

Flexplate

The flywheel/flexplate, as of engine serial number 201681, used in conjunction with automatic transmissions has been changed for 1996. The flywheel/flexplate's thickness has been increased to improve strength.

Flexplate

- **Increased Plate Thickness**
- **Improved Durability**
- **Serial Number 201681**

Injector Torque

Injector bolt torque is **120 lbf/in (13.6 Nm)**. Failure to properly tighten the bolts may lead to engine damage if the copper washer at the bottom of the injector burns away and the lower O-ring melts, allowing fuel to pass the outside of the injector into the combustion cylinder. It is common for relaxation to occur and torque wrenches may indicate less than **120 lbf/in (13.6 Nm)** on the bolts. If less than 50 lbf/in is measured with a wrench and an overfueling type concern exists, such as a knock, smoke, or fuel out the tailpipe, remove the loose injectors for inspection, and repair as necessary. Remember when servicing injectors to lubricate the bolt threads to obtain the proper clamp load and avoid overtightening the bolts since injector damage can occur.

Injector Torque

- **Correct Torque is 120 lbf/in (13.6 Nm)**
- **Insufficient Torque Results in Engine Damage**
- **After engine has been running, if torque is measured it will be less than 120 lbf/in (13.6 Nm) – Should be higher than 50 lbf/in (5.6 Nm).**

Oil Capacity

The oil capacity on all DIT engines is 14 quarts when changing the oil and filter. When released in 1994, the oil level was described as 12 quarts with filter change. The dipstick was changed at the introduction of the 1995 model to indicate full when 14 quarts were installed. The benefit of more oil is less chance for aeration.

Oil Capacity

- **Released 1994 as 12 Quart Capacity**
- **Dipstick Recalibrated for 14 Quart Capacity in 1995 Model Year**
- **Increased Oil Level Provides Better Oil Aeration Protection**

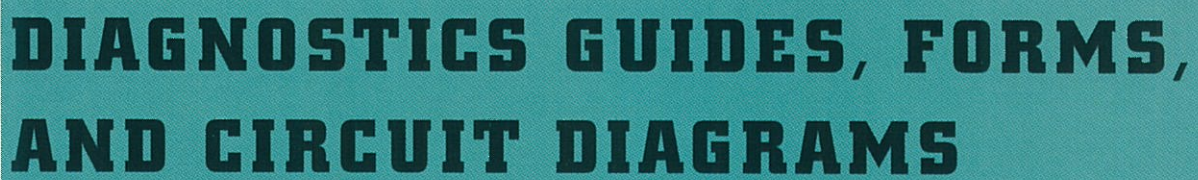
**DIAGNOSTICS GUIDES, FORMS,
AND CIRCUIT DIAGRAMS**

7.3L Diesel Pin Out Values — 1994 1/2

Pin #	Name	Circuit #	Wire Color	Key Off	Key On	Low Idle	High Idle	Operating Range	Comments
2	STO/MIL	688	PK-LG	0v	B+	B+	B+	B+	0v=Light On, 12v=Light Off
4	PBA	977D	P-W	0v	12v/0v	12v/0v	12v/0v	12v/0v	Parking Brake Applied Switch "Up/Down"
5	IVS	308	R-O	0v/0v	0v/12v	0v	12v	0v/12v	Idle Validation Switch PPS Pedal "Up/Down"
13	FEPS	107	P	N/A	N/A	N/A	N/A	N/A	Flash EPROM Power Supply
15	BUS(-)	915	PK-LB	N/A	N/A	N/A	N/A	N/A	Not Used
16	BUS(+)	914	T-O	N/A	N/A	N/A	N/A	N/A	Not Used
25	CASE GND	57Z	BK	0v	0v	0v	0v	0v	Case Ground
29	CPP	306	T-LB	/0v	12v/0v	12v/0v	12v/0v	12v/0v	Clutch Pedal Position Switch "Up/Down"
30	EBP	553	P-LB	0v	.8v-.95v	.8v-.95v	1.25v-1.75v	.8v-3v	Exhaust Back Pressure Sensor
31	BPA	307	BK-Y	0v/0v	12v/0v	12v/0v	12v/0v	12v/0v	Brake Pedal Applied "Up/Down"
33	VSS-	676	PK-O	0v	0v	0v	0v	0v	Vehicle Speed Sensor Ground
34	MAP	358	LG-BK	.2-.5v	2.5v	2.5v	2.5v	110-186 Hz	Manifold Pressure 110/113 Hz - At. Press.
38	EOT	354	LG-R	0v	.35v-4.5v	.35v-4.5v	.35v-4.5v	.75v = 212°F	Engine Oil Temp. 4.7v = -40°F/.68v = 230°F
39	IAT	743	GY	0v	.35v-4.5v	.35v-4.5v	.35v-4.5v	3.07v = 68°F	Intake Air Temp. 4.53v = -40°F/.358v = 230°F
40	SC GND	848	D-GO	0v	0v	0v	0v	0v	Speed Control Ground
42	EPR	318	GY-R	0v	6-8v	6-8v	0v	0v-10v	Exhaust Back Pressure Volt. only when enabled
48	EF	818	GY-W	3-4 v/83 Hz	.6v				Electronic Feedback line, digital 12v frequency
49	CMP	795	DG	0v	12v/2.5v	7v	7v	130-720 Hz	Camshaft Position Sensor 650-3600 RPM
50	TAC	648	W-PK	0v	12v	6.5v/660 Hz	6.5v/660 Hz	130-720 Hz	Tachometer Signal Reflected CMP Signal
51	PWR GND	570A	BK-W	0v	0v	0v	0v	0v	Power Ground
55	KAPWR	37E	Y	B+	B+	B+	B+	B+	Keep Alive Power B+ = battery voltage
58	VSS+	679	GY-BK	Frequency Signal - Varies with Vehicle Speed					Vehicle Speed Signal
61	SCCS	151	LB-BK	0v to 12v	0v to 12v	0v to 12v	0v to 12v	0v to 12v	Speed Control voltage will vary w/ switch position
65	CMP GND	570	BK-W	0v	0v	0v	0v	0 v	Camshaft position sensor ground
66	STI	209	W-P	0v	5v	5v	5v	0 v	Self Test Input 0v
70	IDM-EN	814	W-BK	0v	12v-> 0v	0v	0v	12v/0v	IDM Relay 12v = IDM Off 0v = IDM On
71	VPWR	361B	R	0v	B+	B+	B+	B+	Ignition source pwr.
76	PWR GND	570B	BK-W	0v	0v	0v	0v	0v	Power Ground
77	PWR GND	570C	BK-W	0v	0v	0v	0v	0v	Power Ground
80	GPL	464	BK-PK	0v	0v/12v	12v	12v	0v/12v	Glow Plug Lamp 0v = Light On, 12v = Light Off
83	IPR	552	Y-R	0v	12v	12v	12v	12v	Injection Pressure Reg. Duty Cycle Controlled
84	BARO	356	DB-LG	.75v-3v	.75v-4.9v	.75v-4.9v	.75v-4.9v	.75v-4.9v	4.64v at 100 kPa (sea level) 2.6v at 60 kPa (10,000 ft.)
87	ICP	812	DB-LG	0v	.25-.4v	.75-1v	1.1-1.5v	.65-3.25v	Injection Control Pressure (Min .83v req. for starting)
89	AP	355	GY-W	0v	.5-4v	.5-.9v	3.8-4.2v		Accelerator Pedal Sensor
90	V REF	351	BR-W	.41v	5.0±.5v	5.0±.5v	5.0±.5v	5.0±.5v	Voltage Reference
91	SIG GRD	359	GY-R	0v	0v	0v	0v	0v	Ground for all sensor signals
92	BOO	511	LG	0v/12v	0v/12v	0v/12v	0v/12v	0v/12v	Brake On/Off Switch "Up/Down"
95	FDCS	821	BR-O	0v	.5v	1v/49 Hz	2.7v/200 Hz	43/240 Hz	Fuel Delivery Control Signal 650-3600 RPM
96	CID	817	Y-LB	0v	.5v	6v/5 Hz	6v/720 Hz	5 Hz-720 Hz	Cylinder Identification
97	VPWR	361A	R	0v	B+	B+	B+	B+	Ignition source pwr.
101	GPC	1090	P-O	0v	0v/12v	0v/12v	12v	0v	Glow Plug Cntrl. 0v=(GP relay On) 12v=(GP relay off)
103	PWR GND	570D	BK-W	0v	0v	0v	0v	0v	Power Ground

7.3DIT Electronic Engine Controls 1994 1/2

Engine Mounted Components

Truck Mounted Components

Cab Mounted Components

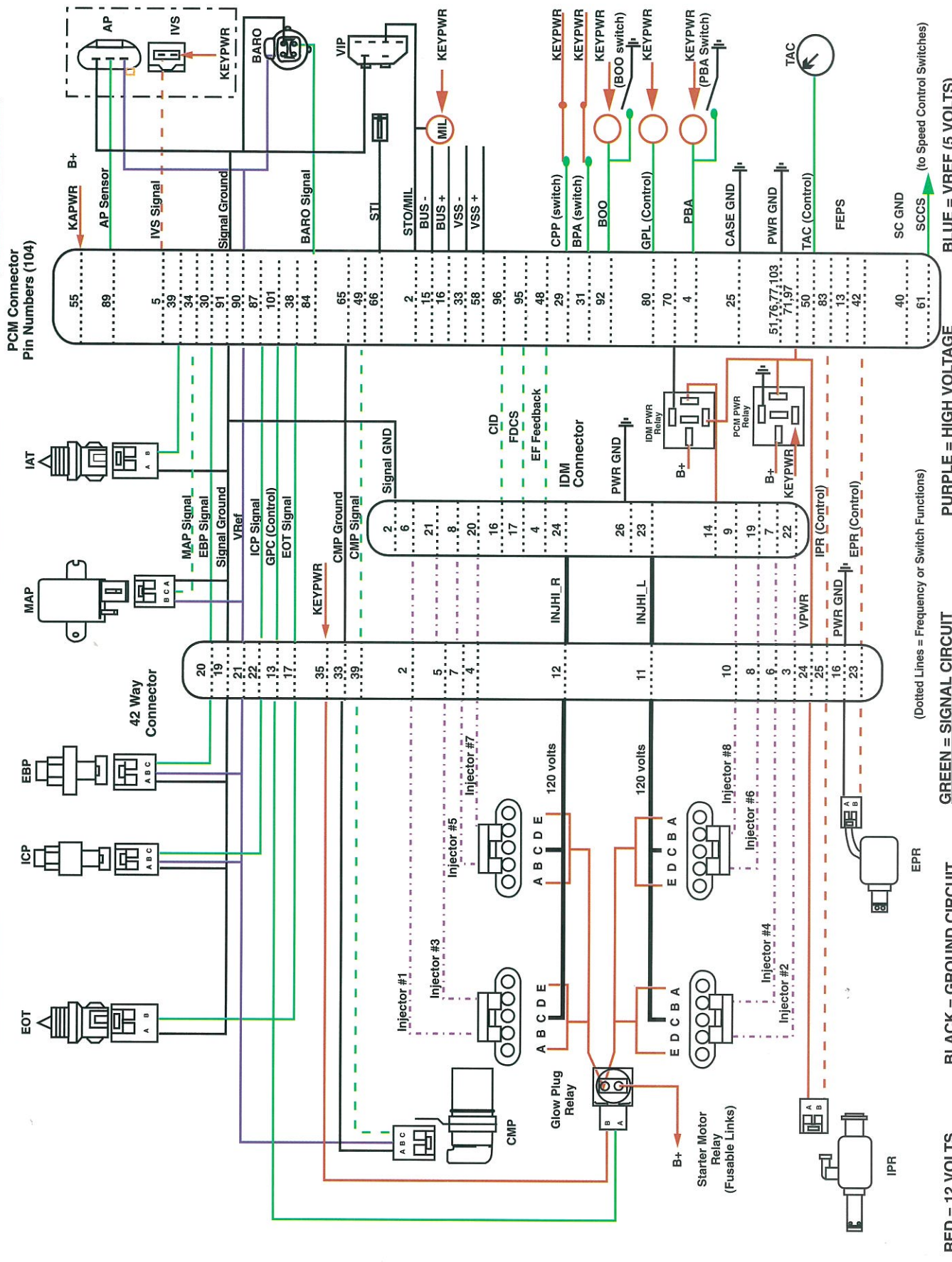

(Dotted Lines = Frequency or Switch Functions)

RED = 12 VOLTS

BLACK = GROUND CIRCUIT

GREEN = SIGNAL CIRCUIT

PURPLE = HIGH VOLTAGE

BLUE = VREF (5 VOLTS)

Power Stroke 1994 1/2

Fault Code	J2012 Code	Circuit Index	Condition Description	Comments	Probable Causes
827	0107	BARO	BARO circuit out of range low	Defaults to 101 Kpa	Open/Grounded circuit, biased sensor or PCM
864	0571	BPA	Brake pedal applied switch fail	Switch Test - KOER (Code set if cruise not present)	
828	0108	BARO	BARO circuit out of range high	Defaults to 101 Kpa	Circuit shorted to 5v, biased sensor or PCM
512	0603	PCED	KAM memory loss	No historical faults output during a KOEO test	Open PCM pin , disconnected B+, faulty PCM
151	0112	IAT	IAT circuit out of range low	Disables back pressure device	Grounded circuit, biased sensor or PCM
511	0605	PCED	PCM ROM test failure		Internal PCM failure
152	0113	IAT	IAT circuit out of range high	Disables back pressure device	Open circuit, biased sensor or PCM, short to 5V
523	0606	PCED	PCM Inactive Background fault	Internal PCM fault	Internal PCM failure
122*	0122	AP/IVS	AP Sensor Signal ORL	Engine will idle only if hard fault	Grounded circuit, biased sensor or PCM
536	0703	BOO	Brake On/Off switch circuit failure	Switch Test - KOER	activate switch KOER.
123*	0123	AP/IVS	AP Sensor Signal ORH	Engine will idle only if hard fault	Open circuit, biased sensor or PCM, short to 5V
528	0704	CPP	CPP switch circuit failure	Switch Test - KOER	Open/short circuit, Switch/PCM failure, failed to
116	0195	EOT	EOT above/below KOER limits	Aborts KOER test	Engine not up to operating temp., leaking thermostat
675	0705	TR	TR sensor circuit malfunction		
117*	0197*	EOT	EOT circuit out of range low	No cold adv. , fast low idle, EBP disabled	Grounded circuit, biased sensor or PCM,
667	0707	TR	TR sensor circuit low input		
118*	0198*	EOT	EOT circuit out of range high	No cold adv. , fast low idle, EBP disabled	Open circuit, biased sensor or PCM, short to 5V
668	0708	TR	TR sensor circuit high input		
815	0219	PCED	Excessive Engine RPM	Transmission incorrectly downshifted or wrong gear selected down hill	
638	0712	TFT	Trans fluid temp sensor ckt low input		
124*	0220*	AP/IVS	Idle validation switch fail	Switch Test -KOER	Short/Open circuit, switch failure, operator, PCM
637	0713	TFT	Trans fluid temp sensor ckt high input		
125*	0221*	AP/IVS	Idle validation switch fail	Engine will idle only if hard fault	Failed Pedal Assembly
629	0741	TCC	Converter Clutch Solenoid Failure		
127*	0235*	MAP	MAP Inactive signal	Uses Inferred MAP signal	Open, short to gnd or 5v, faulty sensor
621	0750	SS1	Shift Solenoid 1 malfunction		
128*	0236*	MAP	MAP In-range failure	Uses Inferred MAP signal	Restricted inlet/exhaust/supply hose, tampering
622	0755	SS2	Shift Solenoid 2 malfunction		
126*	0237*	MAP	MAP signal out of range high/low	Uses Inferred MAP signal	Noise, faulty sensor, Intermittent open
617	0781		1-2 Shift Error		
921*	0261*	INJ	Low side short to grd. inj. crkt. #1	FMEM mode, engine will run on 4 cyl.	Harness short to ground
618	0782		2-3 Shift Error		
931	0262	INJ	Low side short to bat. inj. crkt. #1	FMEM mode, engine will run on 4 cyl.	Miswired connector or harness
619	0783		3-4 Shift Error		
941	0263	PCED	Cylinder fault #1 - CCT	Cylinder not contributing during CCT test	Power cylinder, valve train or injector problem
111	1111	N/A	System Pass	No PCM system faults detected	N/A
922*	0264*	INJ	Low side short to grd. inj. crkt. #2	FMEM mode, engine will run on 4 cyl.	Harness short to ground
841	1211	IPR	ICP pressure is Above/Below Desired	Continuous & On Demand Test - KOER	Failed/stuck IPR valve
932	0265	INJ	Low side short to bat. inj. crkt. #2	FMEM mode, engine will run on 4 cyl.	Miswired connector or harness
819	1212	ICP	ICP higher than expected KOEO	Sensor volt not at expected level with KOEO	Biased sensor or circuit
942	0266	PCED	Cylinder fault #2 - CCT	Cylinder not contributing during CCT test	Power cylinder, valve train or injector problem
915	1218	PCM/IDM	CID stuck high	Cyl. identification line stuck high (historical fault only)	CID circuit open, most likely on intermittent basis
923*	0267*	INJ	Low side short to grd. inj. crkt. #3	FMEM mode, engine will run on 4 cyl.	Harness short to ground
916	1219	PCM/IDM	CID stuck low	Cyl. identification line stuck low (historical fault only)	CID circuit short to ground, most likely intermittent only
933	0268	INJ	Low side short to bat. inj. crkt. #3	FMEM mode, engine will run on 4 cyl.	Miswired connector or harness
961- 968	1261-1268	INJ	High to low side short cyl#1 - #8	Bank with fault will be commanded off	Short circuit, shorted injector, failed IDM
943	0269	PCED	Cylinder fault #3 - CCT	Cylinder not contributing during CCT test	Power cylinder, valve train or injector problem
971- 978	1271-1278	INJ	High to low side open cyl#1 - #8	Bank with fault will be commanded off	Open circuit, Open injector, failed IDM
924*	0270*	INJ	Low side short to grd. inj. crkt. #4	FMEM mode, engine will run on 4 cyl.	Harness short to ground
153	1280	ICP	ICP circuit out of range low	Uses inferred ICP strategy	Open/Grounded circuit, biased sensor or PCM
934	0271	INJ	Low side short to bat. inj. crkt. #4	FMEM mode, engine will run on 4 cyl.	Miswired connector or harness
154	1281	ICP	ICP circuit out of range high	Uses inferred ICP strategy	Circuit shorted to 5v, biased sensor or PCM
944	0272	PCED	Cylinder fault #4 - CCT	Cylinder not contributing during CCT test	Power cylinder, valve train or injector problem
155	1282	IPR	Excessive ICP pressure	System fault	Faulty IPR regulator (sticking), IPR shorted to ground
925*	0273*	INJ	Low side short to grd. inj. crkt. #5	FMEM mode, engine will run on 4 cyl.	Harness short to ground
546	935	0274	INJ	Low side short to bat. inj. crkt. #5	FMEM mode, engine will run on 4 cyl. ↗ Miswired connector or harness
945	0275	PCED	Cylinder fault #5 - CCT	Cylinder not contributing during CCT test	Power cylinder, valve train or injector problem
926*	0276*	INJ	Low side short to grd. inj. crkt. #6	FMEM mode, engine will run on 4 cyl.	Harness short to ground
992	936	0277	INJ	Low side short to bat. inj. crkt. #6	FMEM mode, engine will run on 4 cyl. Miswired connector or harness
946	0278	PCED	Cylinder fault #6 - CCT	Cylinder not contributing during CCT test	Power cylinder, valve train or injector problem
927*	0279*	INJ	Low side short to grd. inj. crkt. #7	FMEM mode, engine will run on 4 cyl.	Harness short to ground
995*	1295*	INJ	Multiple faults on bank #1(right)	Fix low side short and rerun diagnostics	Miswired connector or harness, short to ground
937	0280	INJ	Low side short to bat. inj. crkt. #7	FMEM mode, engine will run on 4 cyl.	Miswired connector or harness
947	0281	PCED	Cylinder fault #7 - CCT	Cylinder not contributing during CCT test	Power cylinder, valve train or injector problem
997	1297	INJ	High sides shorted together		Shorted wires, faulty IDM
928*	0282*	INJ	Low side short to grd. inj. crkt. #8	FMEM mode, engine will run on 4 cyl.	Harness short to ground
938	0283	INJ	Low side short to bat. inj. crkt. #8	FMEM mode, engine will run on 4 cyl.	Miswired connector or harness
539	1464	N/A	A/C on during KOER	Aborts KOER test	N/A
948	0284	PCED	Cylinder fault #8 - CCT	Cylinder not contributing during CCT test	Power cylinder, valve train or injector problem
843	1501	N/A	Vehicle moved during KOER	Aborts KOER Test	N/A
818	0340	CMP	Inactive CMP sensor	No CMP sensor signal detected during cranking	Open/grounded circuit/sensor fault
844	1530	N/A	Invalid CCT test - pedal movement	Aborts KOER Test	N/A
817	0341	CMP	Noise Rejection	Electrical Noise Detected	Harness routing, charging circuit problems, sensor fault
863	1536	PBA	PBA parking brake applied fail	Switch Test - KOER	Open/short circuit., Switch/PCM failure, failed to

POWERTRAIN CONTROL SYSTEM ELECTRONICS DIAGNOSTIC GUIDE

Fault Code	J2012 Code	Circuit Index	Condition Description	Comments	Probable Causes
816	0344	CMP	CMP/SYNC Counts	Incorrect number of CMP transition counts	CAMP Sensor fault, Noise Coupling
549	1662	PCED	IDM_EN circuit failure	IDM Enable Relay OCC - KOEO only	Open relay, blown fuse, open grounded circuit
515	0380	GP	GP relay output circuit failure	Glow Plug Relay OCC - KOEO only	Open/grounded crkt., solenoid open/shorted, failed PCM
956	1663	PCM/IDM	FDCS circuit failure	Fuel demand command signal - OCC check - KOEO	Open /grounded circuit, faulty IDM
516	0381	GP	GP Lamp output circuit failure	Glow Plug Lamp OCC - KOEO only	Open/grounded circuit, lamp open, failed PCM
955	1667	PCM/IDM	CID circuit failure	Cyl. identification circuit -OCC check - KOEO only	Open /grounded circuit, faulty IDM
145	0472	EBP	EBP circuit out of range low	Disables back pressure device	Open/grounded circuit, biased sensor or PCM
983	1668	PCM/IDM	PCM-IDM diag. communication error	Communication on EF (Electronic Feedback line)	Open/shorted EF or FDCS wire, open IDM grd.
146	0473	EBP	EBP circuit out of range high	Disables back pressure device	Circuit shorted to 5v, biased sensor or PCM
654	1705	TR	TR sensor out of self test range		
514	0475	EPR	EPR circuit failure	Exhaust Back pressure Regulator OCC	Open/grounded crkt., solenoid open/shorted, failed PCM
636	1706		High vehicle speed in Park		
842	0476	EPR	EBP pressure Above/Below Desired	On Demand Test - KOER	Failed/stuck EPR valve
636,7,8	1711	TFT	TFT sensor out of self test range		
147	0478	EPR	Excessive back pressure	Disables back pressure device	Plugged sensor line, stuck butterfly, restricted exhaust
628	1728		Trans. slip (converter clutch failed)		
452	0500	VSS	Vehicle speed sensor malfunction		
691	1729	4x4L	4x4 Low Switch Error		
845	0560	PCED	B+. volt too low for CCT test	Aborts KOER Test	Charging system problem/load, glow plugs still enabled
625	1746	EPC	EPC solenoid open circuit		
518	0562	PCED	Battery voltage below normal	May be temporary condition at crank only.	Low Syst. Voltage, Charging Sys., Internal PCM failure
624	1747	EPC	EPC solenoid short circuit		
517	0563	PCED	Battery voltage above normal	May be temporary condition - 24V jump start	High Syst. Voltage, Charging Sys., Internal PCM failure
	1748	EPC	EPC malfunction		
831	0565	PCED	Spd Cntrl ON not pressed	Switch Test - KOER (Code set if cruise not present)	Open or short circuit, Switch failure, PCM failure or failed
641	1754	CCS	Coast Clutch Solenoid ckt. malfunction		
832	0566	PCED	Spd Cntrl OFF not pressed	Switch Test - KOER (Code set if cruise not present)	to activate switch during the KOER test.
631	1779	TCIL	TCIL circuit out of self test range		
833	0567	PCED	Spd Cntrl RESUME not pressed	Switch Test - KOER (Code set if cruise not present)	
632	1780	TCS	TCS circuit out of self test range		
834	0568	PCED	Spd Cntrl SET not pressed	Switch Test - KOER (Code set if cruise not present)	Cruise control codes will be set on every switch test
691	1781	4X4L	4X4L circuit out of self test range		
835	0569	PCED	Spd Cntrl COAST not pressed	Switch Test - KOER (Code set if cruise not present)	on vehicles not equipped with cruise control.
657	1783	TFT	Transmission Overtemperature Condition		

* Indicate MIL lamp illuminated when fault present

PCED = Powertrain Control Emissions Diagnostic Manual

KOEO — Standard Test

- Turn all accessories off
- Set STAR tester to Fast Code position
- Latch STAR test button on (ground STI)
- Turn key to ON position
- Unlatching the STAR tester during "fast" code transmission will clear all codes in the PCM
(They will be stored in the STAR tester for viewing)

KOEO Key On Engine Off — Buzz Test

- Turn all accessories off
- Latch STAR test button on (ground STI)
- Turn key to ON position
- After "fast" code transmission depress and release brake to abort slow codes
- Depress and release accelerator pedal to start test
- Codes will be displayed at end of test

(Test can be repeated by depressing and releasing accelerator pedal twice)

Note: The engine will run rough during the KOER Standard and Cylinder Contribution Tests!

KOER Key On Engine Running —Standard Test

- Turn all accessories off
- Engine oil temperature must be up to a minimum of 176°F (80°C)
- Set Star tester to Fast Code position, latch Star test button on (ground STI), start engine
- After Code 50 is transmitted, depress and release the following switches:
 - Accelerator Pedal (must depress and release first)
 - Cruise Control On, Off, Resume, Set/Accel, Coast
 - Emergency Brake and Clutch Pedal
 - Brake Pedal (must depress and release last) — Stab firmly to activate brake pressure switch
- At the end of the switch test the PCM will perform the ICP and EBP step tests
- Depressing and releasing the brake pedal after the last test will stop the CCT test and allow the PCM to transmit codes

KOER Cylinder Contribution Test

- This test will run automatically after a KOER test
- Codes 51 thru 58 will be transmitted to indicate the cylinder under test
- Pass or fail codes will be transmitted at end of test
- This test can be accessed directly by starting a KOER test depressing and releasing the accelerator pedal once and the brake pedal two times (Ignore resultant switch codes)

7.3L Diesel Pin Out Values — 1996

Pin #	Name	Circuit #	Wire Color	Key Off	Key On	Low Idle	High Idle	Operating Range	Comments
1 ^a	SS2	315	P-O	0v	12v	12v	12v	0v/12v	Shift Solenoid #2 0v = "On" 12v = "Off"
2	Check Engine Light	658	PK-LG	0v	B+	B+	B+	B+	0v=Light On, 12v=Light Off
4 ^b	PBA	977D	P-W	0v	12v/0v	12v/0v	12v/0v	12v/0v	Parking Brake Applied Switch "Up/Down"
5	IVS	308	R-O	0v	0v/12v	0v	12v	0v/12v	Idle Validation Switch "Up/Down"; Open at idle
13	FEPS	107	P	N/A	N/A	N/A	N/A	N/A	Flash EPROM Power Supply
14 ^a	4X4L	784	LB-BK	0v	12v/0v	12v/0v	12v/0v	12v/0v	4x4 Low Switch 12v = "Off", 0v = "On"
15	BUS(-)	915	PK-LB	N/A	N/A	N/A	N/A	N/A	Data Link Connector
16	BUS(+)	914	T-O	N/A	N/A	N/A	N/A	N/A	Data Link Connector
25	CASE GND	57Z	BK	0v	0v	0v	0v	0v	Case Ground
27 ^a	SS1	237	O-Y	0v	0v	0v	0v	0v/12v	Shift Solenoid #1 0v = "On", 12v = "Off"
28 ^a	TCC	480	P-Y	0v	12v	12v	12v	0v/12v	Converter Clutch Solenoid 0v = "On", 12v = "Off"
29	CPP(Manl)	306	T-LB	0v	12v/0v	12v/0v	12v/0v	12v/0v	Clutch Pedal Position Switch (Manual)
	TCS(Auto)	224	T/W	0v	12v/0v	12v/0v	12v/0v	12v/0v	Transmission Control Switch (Automatic)
30	EBP	553	P-LB	0v	.8v-.95v	1.25v-1.75v	1.25v-1.75v	.8v-3v	Exhaust Back Pressure Sensor
31 ^c	BPA	307	BK-Y	0v	12v/0v	12v/0v	12v/0v	12v/0v	Brake Pedal Applied "Up/Down"
33	VSS(-)	676	PK-O	0v	0v	0v	0v	0v	Vehicle Speed Sensor Ground
34	MAP	358	LG-BK	.2v-.5v	2.5v	2.5v	2.5v	110-186 Hz	Manifold Pressure 110/113 Hz = At. Press.
37 ^a	TFT	923	O-BK	0v	.3v-4.5v	.3v-4.5v	.3v-4.5v	.46v-212°F	Transmission Fluid Temp. 4.5v=-40°F/3v=230°F
38	EOT	354	LG-R	0v	.35v-4.5v	.35v-4.5v	.35v-4.5v	.75v-212°F	Engine Oil Temp. 4.7v=-40°F/68v=230°F
39	IAT	743	GY	0v	.35v-4.5v	.35v-4.5v	.35v-4.5v	3.07v=68°F	Intake Air Temp. 4.53v=-40°F/358v=230°F
40 ^d	SC GND	848	DG-O	0v	0v	0v	0v	0v	Speed Control Ground
41 ^{a,e}	ACC	198	DG-O	0v	12v/0v	12v/0v	12v/0v	12v/0v	Air Conditioning Clutch 12v = "On", 0v = "Off"
42	EPR	318	GY-R	0v	6v-8v	6v-8v	0v	0v-10v	Exhaust Back Pressure Volt. only when enabled
48	EF	818	GY-W	0v	3.3v avg.	.4v-2.2v	1.9v-2.2v	.4v-2.2v	Electronic Feedback Line, digital 12v frequency
49	CMP	795	DG	0v	12v/2.5v	7v	7v	130-720 Hz	Camshaft Position Sensor 650-3600 RPM
50 ^g	TAC	648	W-PK	0v	12v	6.5v/130 Hz	6.5v/660 Hz	130-720 Hz	Tachometer Signal Reflected CMP Signal
51	PWR GND	570A	BK-W	0v	0v	0v	0v	0v	Power Ground
53 ^a	CCS	924	BR-O	0v	0v	0v	0v	0v/12v	Coast Clutch Solenoid 0v = "On", 12v = "Off"
55	KAPWR	37E	Y	B+	B+	B+	B+	B+	Keep Alive Power B+ = battery voltage
58	VSS(+)	679	GY-BK	B+	B+	B+	B+	B+	Vehicle Speed Signal
61	SCCS	151	LB-BK	0v	0v to 12v	0v to 12v	0v to 12v	0v to 12v	Cruise Cntrl. Voltage will vary with switch position
64 ^a	TR	199	LB-Y	0v	4.5v	4.5v	4.5v	0v-4.5v	Transmission Range Sensor P = 4.5v, R = 3.7v, N = 2.9v, D = 2.2v, MAN2 = 1.4v, MAN1 = .7v
65	CMP GND	796	LB	0v	0v	0v	0v	0v	Camshaft position sensor ground
70	IDM_EN	814	W-BK	0v	12v-> 0v	0v	0v	12v/0v	IDM Relay 12v = IDM Off 0v = IDM On
71	VPWR	361B	R	0v	B+	B+	B+	B+	Ignition source pwr.
76	PWR GND	570B	BK-W	0v	0v	0v	0v	0v	Power Ground
77	PWR GND	570C	BK-W	0v	0v	0v	0v	0v	Power Ground
79 ^a	TCIL	911	W-LG	0v	12v/0v	12v/0v	12v/0v	12v/0v	Trans Control Indicator Light 12v = "Off", 0v = "On"
80	GPL	464	BK-PK	0v	0v/12v	12v	12v	0v/12v	Glow Plug Lamp 0v = Light On, 12v = Light Off
81 ^a	EPC	925	W-Y	0v	4.5v	7.5v	12v	7.5v-12v	Electronic Pressure Control Solenoid
83	IPR	552	Y-R	0v	12v	12v	12v	12v	Injection Pressure Reg. Duty Cycle Controlled
84	BARO	356	DB-LG	.75v-3v	.75v-4.9v	.75v-4.9v	.75v-4.9v	.75v-4.9v	4.64v at 100 kPa (sea level) 2.6v at 60 kPa (10,000 ft.)
87 ^f	ICP	812	DB-LG	0v	.25v-.4v	.75v-1v	1.1v-1.5v	.65v-3.25v	Injection Control Pressure (Min. .83v req. for starting)
89	AP	355	GY-W	0v	.5v-4v	.5v-.9v	3.8v-4.2v	.5v-4v	Accelerator Pedal Sensor
90	V REF	351	BR-W	.41v	5.0±.5v	5.0±.5v	5.0±.5v	5.0±.5v	Voltage Reference
91	SIG GRD	359	GY-R	0v	0v	0v	0v	0v	Ground for all sensor signals
92	BOO	511	LG	0v/12v	0v/12v	0v/12v	0v/12v	0v/12v	Brake On/Off Switch "Up/Down"
95	FDCS	821	BR-O	0v	.5v	1v-49 Hz	2.7v/200 Hz	43-240 Hz	Fuel Delivery Control Signal 650-3600 RPM
96	CID	817	Y-LB	0v	.5v	6v/720 hZ	6v/720 hZ	5 Hz-720 Hz	Cylinder Identification
97	VPWR	361A	R	0v	B+	B+	B+	B+	Ignition source pwr.
101	GPC	1086	P-O	0v	0v/12v	0v/12v	0v/12v	0v/12v	Glow Plug Cntrl. 0v=(GP relay On) 12v=(GP relay off)
103	PWR GND	570D	BK-W	0v	0v	0v	0v	0v	Power Ground

a E40D transmission only
 b 162 (LG/R) for Econoline applications
 c 810 (R/LG) for Econoline applications

d 563 (O/Y) for Econoline applications
 e 347 (BK/Y) for Econoline applications
 f 535 (LB/R) for Econoline applications

g Not used on Econoline applications

7.3L DI Turbo Diesel Powertrain Control System Schematic - 1995/1996

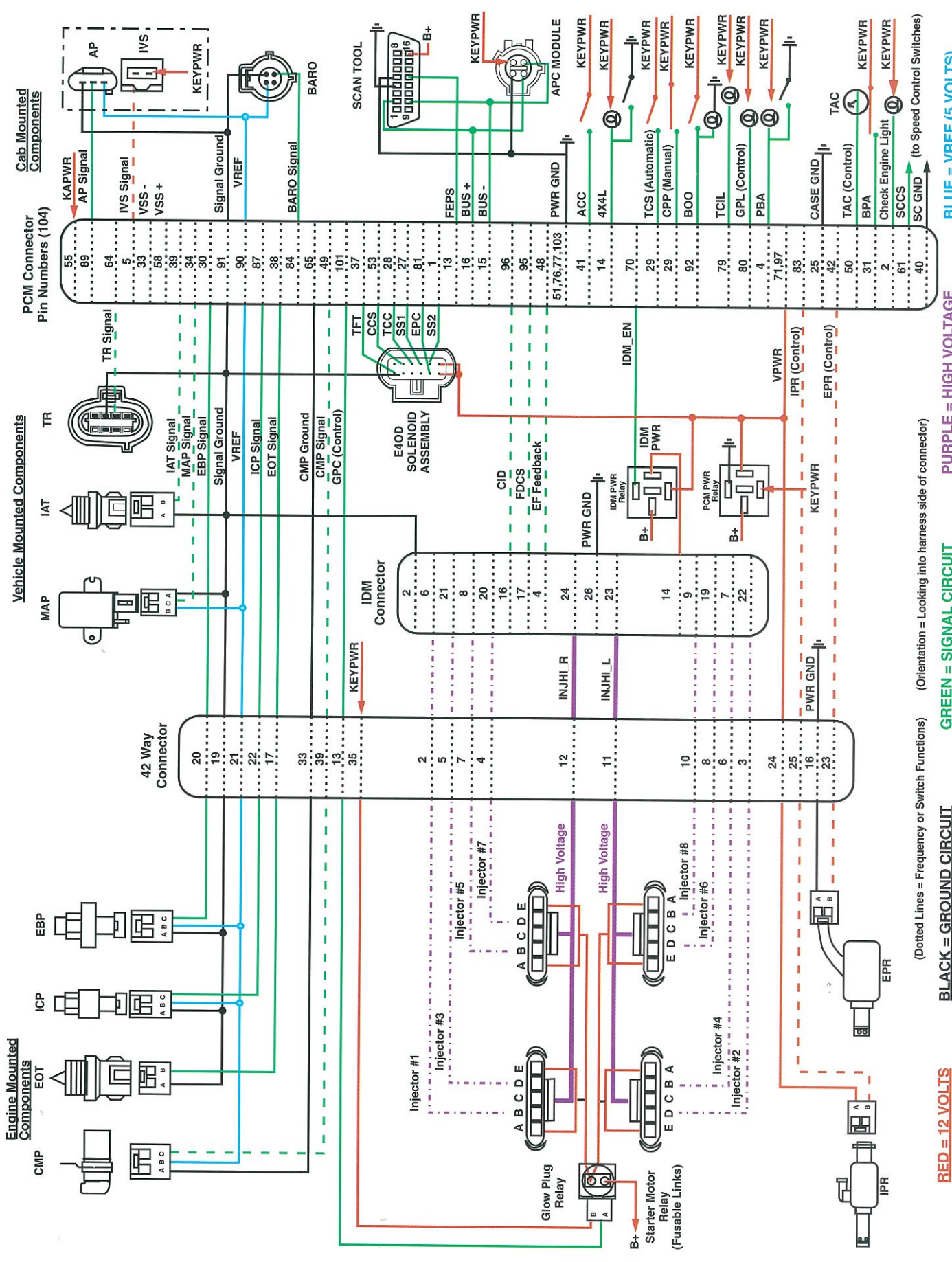

(Dotted Lines = Frequency or Switch Functions) (Orientation = Looking into harness side of connector)

RED = 12 VOLTS

BLACK = GROUND CIRCUIT

GREEN = SIGNAL CIRCUIT

PURPLE = HIGH VOLTAGE

BLUE = VREF (5 VOLTS)

Power Stroke 1995/1996

Fault Code	Circuit Index	Condition Description	Comments	Probable Causes
0107	BARO	Barometric press sensor circuit low input	Defaults to 100 kPa	Open/grounded circuit, biased sensor, PCM
0108	BARO	Barometric press sensor circuit high input	Defaults to 100 kPa	Circuit shorted to 5V, biased sensor, PCM
0112	AT	Intake air temp sensor circuit low input	Defaults to 15°C	Grounded circuit, biased sensor, PCM
0113	AT	Intake air temp sensor circuit high input	Defaults to 15°C	Open circuit, biased sensor, PCM, short to 5V
0122	AP	Accelerator pedal sensor circuit low input	Engine will only idle if hard fault	Grounded circuit, biased sensor, PCM
0123	AP	Accelerator pedal sensor circuit high input	Engine will only idle if hard fault	Open circuit, biased sensor, PCM, short to 5V
0195	EOT	EOT Sensor ckt malfunction (95 MY)	Aborts KOER CCT test	Engine not up to operating temp., leaking thermostat
0196	EOT	EOT Sensor ckt malfunction (96 MY)	Aborts KOER CCT test	Engine not up to operating temp., leaking thermostat
0197	EOT	Engine oil temp sensor circuit low input	No cold adv., fast low idle	Grounded circuit, biased sensor, PCM
0198	EOT	Engine oil temp sensor circuit high input	No cold adv., fast low idle	Open circuit, biased sensor, PCM, short to 5V
0220	VS	Throttle switch B circuit malfunction	Switch test - KOER	Short/open circuit, switch failure, operator, PCM
0221	AP/IVS	Throttle switch B circuit performance	AP/IVS disagree - Engine will only idle if hard fault	Failed pedal assembly
0235	MAP	Turbo boost sensor A circuit performance	Uses Inferred MAP signal	Open, short to ground or 5v, faulty sensor
0236	MAP	Turbo boost sensor A circuit performance	Uses Inferred MAP signal	Restricted inlet/exhaust/supply hose
0237	MAP	Turbo boost sensor A circuit low input	Uses Inferred MAP signal	Sensor, PCM (95MY) Open, short, sensor, PCM (96MY)
0238	MAP	Turbo boost sensor A circuit high input	Uses Inferred MAP signal	Noise, faulty sensor
0261	NJ	Injector circuit low - Cylinder 1	FMEM mode, engine will run on 4 cyl.	Harness short to ground
0262	NJ	Injector circuit high - Cylinder 1	FMEM mode, engine will run on 4 cyl.	Miswired connector or harness
0263	NJ	Cylinder 1 contribution/balance fault	Cylinder not contributing during CCT test	Power cylinder, valve train or injector problem, circuit
0264	NJ	Injector circuit low - Cylinder 2	FMEM mode, engine will run on 4 cyl.	Harness short to ground
0265	NJ	Injector circuit high - Cylinder 2	FMEM mode, engine will run on 4 cyl.	Miswired connector or harness
0266	NJ	Cylinder 2 contribution/balance fault	Cylinder not contributing during CCT test	Power cylinder, valve train or injector problem, circuit
0267	NJ	Injector circuit low - Cylinder 3	FMEM mode, engine will run on 4 cyl.	Harness short to ground
0268	NJ	Injector circuit high - Cylinder 3	FMEM mode, engine will run on 4 cyl.	Miswired connector or harness
0269	NJ	Cylinder 3 contribution/balance fault	Cylinder not contributing during CCT test	Power cylinder, valve train or injector problem, circuit
0270	NJ	Injector circuit low - Cylinder 4	FMEM mode, engine will run on 4 cyl.	Harness short to ground
0271	NJ	Injector circuit high - Cylinder 4	FMEM mode, engine will run on 4 cyl.	Miswired connector or harness
0272	NJ	Cylinder 4 contribution/balance fault	Cylinder not contributing during CCT test	Power cylinder, valve train or injector problem, circuit
0273	NJ	Injector circuit low - Cylinder 5	FMEM mode, engine will run on 4 cyl.	Harness short to ground
0274	NJ	Injector circuit high - Cylinder 5	FMEM mode, engine will run on 4 cyl.	Miswired connector or harness
0275	NJ	Cylinder 5 contribution/balance fault	Cylinder not contributing during CCT test	Power cylinder, valve train or injector problem, circuit
0276	NJ	Injector circuit low - Cylinder 6	FMEM mode, engine will run on 4 cyl.	Harness short to ground
0277	NJ	Injector circuit high - Cylinder 6	FMEM mode, engine will run on 4 cyl.	Miswired connector or harness
0278	NJ	Cylinder 6 contribution/balance fault	Cylinder not contributing during CCT test	Power cylinder, valve train or injector problem, circuit
0279	NJ	Injector circuit low - Cylinder 7	FMEM mode, engine will run on 4 cyl.	Harness short to ground
0280	NJ	Injector circuit high - Cylinder 7	FMEM mode, engine will run on 4 cyl.	Miswired connector or harness
0281	NJ	Cylinder 7 contribution/balance fault	Cylinder not contributing during CCT test	Power cylinder, valve train or injector problem, circuit
0282	NJ	Injector circuit low - Cylinder 8	FMEM mode, engine will run on 4 cyl.	Harness short to ground
0283	NJ	Injector circuit high - Cylinder 8	FMEM mode, engine will run on 4 cyl.	Miswired connector or harness
0284	NJ	Cylinder 8 contribution/balance fault	Cylinder not contributing during CCT test	Power cylinder, valve train or injector problem, circuit
0340	CMP	Camshaft position sensor ckt malfunction	No CMP sensor signal detected during crank	Open/grounded circuit, sensor fault, short to power
0341	CMP	Camshaft position sensor ckt performance	Electrical noise detected	Harness routing, charging circuit, sensor
0344	CMP	Camshaft position sensor ckt intermittent	Incorrect number of CMP transition counts	Harness routing, charging ckt, sensor, int ckt, improper gap
0380	GPC	Glow plug circuit malfunction	Continuous and KOEO on-demand test	Open/grounded ckt, solenoid open/shorted, failed PCM
0381	GPL	Glow plug indicator circuit malfunction	Continuous and KOEO on-demand test	Open/grounded circuit, lamp open, failed PCM
0470	EBP	Exhaust press sensor circuit malfunction	No-start or crank mode	Biased sensor, open signal return
0471	EBP	Exhaust press sensor circuit performance	Continuous	Plugged, stuck, or leaking hose
0472	EBP	Exhaust press sensor circuit low input	Disables back pressure device	Open/grounded circuit, biased sensor, PCM
0473	EBP	Exhaust press sensor circuit high input	Disables back pressure device	Circuit shorted to 5V, biased sensor, PCM
0475	EPR	Exhaust press control valve malfunction	Continuous & KOEO on-demand test	Open/grounded ckt, solenoid open/shorted, failed PCM
0476	EPR	Exhaust press control valve performance	KOER on-demand test	Failed/stuck EPR, EBP fault, EPR circuit
0478	EPR	Exhaust press control valve high input	Excessive back pressure - Continuous	Plugged sensor line, stuck butterfly, restricted exhaust
0500	VSS	Vehicle speed sensor malfunction	Continuous	Sensor, circuit, PCM, PSOM, low trans fluid
0560	PCED	System voltage malfunction	B+ too low for KOER on-demand or CCT test - aborts test	Charging system problem/load, glow plugs still enabled
0562	PCED	System voltage low	May be temporary condition at crank only	Low sys voltage, charging sys, internal PCM failure
0563	PCED	System voltage high	May be temporary condition - 24V jump start	High sys voltage, charging sys, internal PCM failure
0565	PCED	Cruise On signal malfunction	KOER switch test (Code set if cruise not present)	Open or short circuit, switch failure, PCM failure or failed
0566	PCED	Cruise Off signal malfunction	KOER switch test (Code set if cruise not present)	to activate switch during KOER switch test
0567	PCED	Cruise Resume signal malfunction	KOER switch test (Code set if cruise not present)	
0568	PCED	Cruise Set signal malfunction	KOER switch test (Code set if cruise not present)	Cruise control and BPA codes will be set on every switch
0569	PCED	Cruise Coast signal malfunction	KOER switch test (Code set if cruise not present)	test on vehicles not equipped with cruise control.
0571	BPA	Brake switch A circuit malfunction	KOER switch test (Code set if cruise not present)	
0603	PCED	Powertrain Control Module KAM test error	No historical faults output during self test	Open PCM pin, disconnected B+, faulty PCM
0605	PCED	Powertrain Control Module ROM test error	Internal PCM failure	Internal PCM failure
0606	PCED	PCM processor fault	PCM inactive background fault	Internal PCM failure
0703	BOO	Brake switch B circuit malfunction	KOER switch test	Open/short circuit, switch, PCM, failed to activate
0704	CPP	Clutch switch input circuit malfunction	KOER switch test	switch during KOER switch test
0707	TRS	Trans range sensor circuit low input	Continuous	Short to ground Analog TRS
0708	TRS	Trans range sensor circuit high input	Continuous	Open analog TRS, open pin 64 digital TRS
0712	TFT	Trans fluid temp sensor ckt low input	KOEO, KOER, and Continuous	Short to ground, biased sensor, PCM
0713	TFT	Trans fluid temp sensor ckt high input	KOEO, KOER, and Continuous	Open circuit, biased sensor, PCM, short to power
0741	TCC	Torque converter clutch ckt performance	Continuous	Faulty solenoid, PCM, converter hydraulic system
0750	SS1	Shift solenoid A malfunction	KOEO and Continuous	Circuit failure, faulty solenoid, PCM
0755	SS2	Shift solenoid B malfunction	KOEO and Continuous	Circuit failure, faulty solenoid, PCM
0781	N/A	1-2 shift error	Continuous	Circuit failure, faulty solenoid, faulty clutch, PCM
0782	N/A	2-3 shift error	Continuous	Circuit failure, faulty solenoid, faulty clutch, PCM

POWERTRAIN CONTROL SYSTEM ELECTRONICS DIAGNOSTIC GUIDE

Fault Code	Circuit Index	Condition Description	Comments	Probable Causes
0783	N/A	3-4 shift error	Continuous	Circuit failure, faulty solenoid, faulty clutch, PCM
1111	N/A	System Pass	No PCM system faults	N/A
1211	IPR	ICP pressure above/below desired	Continuous and KOER on-demand test	IPR valve failed, stuck, or shorted to ground
1212	ICP	ICP press not detected during crank	Crank or KOEO	Biased sensor or ckt, open signal return, low oil in reservoir
1218	PCM/IDM	CI stuck high	Cylinder identification line stuck high	CI circuit open, probably intermittent
1219	PCM/IDM	CI stuck low	Cylinder identification line stuck low	CI circuit short to ground, probably intermittent
1261-1268	INJ	High to low side short cyl#1 - #8	Cylinder with fault will not operate	Short circuit, shorted injector, failed IDM
1271-1278	INJ	High to low side open cyl#1 - #8	Cylinder with fault will not operate	Open circuit, open injector, failed IDM
1280	ICP	ICP circuit out of range low	Uses inferred ICP strategy	Open/grounded circuit, biased sensor, PCM
1281	ICP	ICP circuit out of range high	Uses inferred ICP strategy	Circuit shorted to 5V, biased sensor, PCM
1282	IPR	Excessive ICP pressure	System fault	Faulty IPR regulator (sticking), IPR shorted to ground
1283	IPR	IPR circuit failure	Continuous & KOEO on-demand test	Open/grounded circuit, stuck IPR, loose connection
1284	N/A	ICP failure - aborts KOER test	Aborts KOER CCT and on-demand tests See codes 1280, 1281, 1282, 1283, 1211	Sensor circuit fault
1291	INJ	High side short to grd or B+, bank #1 (right)	Inj power supply circuit short (operates on 4 cylinders)	Shorted circuit, faulty IDM
1292	INJ	High side short to grd or B+, bank #2 (left)	Inj power supply circuit short (operates on 4 cylinders)	Shorted circuit, faulty IDM
1293	INJ	High side open bank #1 (right)	Inj power supply circuit open (operates on 4 cylinders)	Open circuit, faulty IDM
1294	INJ	High side open bank #2 (left)	Inj power supply circuit open (operates on 4 cylinders)	Open circuit, faulty IDM
1295	INJ	Multiple faults on bank #1 (right) with low side short	Fix low side short and rerun diagnostics	Miswired connector or harness, short to ground
1296	INJ	Multiple faults on bank #2 (left) with low side short	Fix low side short and rerun diagnostics	Miswired connector or harness, short to ground
1297	INJ	High sides shorted together	Fix shorts and rerun diagnostics	Shorted wires, faulty IDM
1298	PCED	IDM failure	Internal IDM failure	Internal IDM failure
1464	N/A	A/C demand out of self test range	Aborts KOER CCT test	Operator error, A/C circuit shorted to power
1531	N/A	Invalid test - accelerator pedal movement	Aborts test - KOER on-demand or CCT test	Operator error
1536	PBA	Parking brake switch circuit failure	KOER switch test	Failed to activate switch during test, circuit, switch, PCM
1660	PCED	OCC signal high	Aborts KOEO on-demand test	High system voltage, internal PCM fault
1661	PCED	OCC signal low	Aborts KOEO on-demand test	Low system voltage, internal PCM fault
1662	PCED	IDM_EN circuit failure	Continuous & KOEO on-demand test	Open IDM relay, blown fuse, open/grounded circuit
1663	PCM/IDM	FDCS circuit failure	Fuel demand command signal - KOEO on-demand test	Open/grounded circuit, faulty IDM
1667	PCM/IDM	CI circuit failure	Cylinder identification circuit - KOEO on-demand test	Open/grounded circuit, faulty IDM
1668	PCM/IDM	PCM-IDM diagnostic communication error	Electronic feedback line - KOEO on-demand test	Open/shorted EF or FDCS, open IDM ground
1705	TRS	TR sensor out of self test range	Not in PARK during KOEO or KOER	Operator error, circuit failure, faulty sensor, PCM
1711	TFT	TFT sensor out of self test range	Transmission fluid temp too high or low for KOEO or KOER test circuit failure, faulty sensor, PCM	Transmission too hot or cold,
1728	TCC	Transmission slip error	Continuous	Solenoid failure or mechanical failure
1729	4x4L	4x4 Low switch error	Continuous	Circuit failure, faulty switch, PCM
1746	EPC	EPC solenoid open circuit	Continuous	Open circuit, faulty solenoid, PCM
1747	EPC	EPC solenoid short circuit	Continuous	Short circuit, faulty solenoid, PCM shorted to ground
1748	EPC	EPC malfunction		Circuit failure, PCM
1754	CCS	Coast clutch solenoid circuit malfunction	Continuous & KOEO on-demand test	Circuit failure, faulty solenoid, PCM
1779	TCIL	TCIL circuit malfunction	KOEO OCC test	Sort to ground, PCM
1780	TCS	TCS circuit out of self test range	KOER switch test	Circuit, switch, PCM, failed to activate switch
1781	4X4L	4X4L circuit out of self test range	In 4X4L during KOEO	Operator error, short to ground, PCM
1783	TFT	Transmission overtemperature condition	Continuous	Internal transmission failure, circuit failure, sensor, PCM

Indicates Check Engine Light illuminated when fault present

Indicates Transmission Control Indicator Light (TCIL) flashes when fault present

PCED = Powertrain Control Emissions Diagnostics Manual

7.3L Diesel Pin Out Values 1997 — ALL Econoline (49 state and California) adn F-250/F-350 (California only)

Pin #	Name	Circuit #	Wire Color	Key Off	Key On /	Low Idle	High Idle	Operating Range	Comments
2	Check Engine Light	658	PK-LG	0v	0v/12v	0v/12v	0v/12v	0v/12v	0v=Light On, 12v=Light Off
5	PBA	162	LG-R	0v	0v/12v	0v/12v	0v/12v	0v/12v	Parking Brake Applied Switch 12v = Brake off, 0v = Brake on
6 ^a	SS1	237	O-Y	0v	0v	0v	0v	0v/12v	Shift Solenoid #1; 0v = "On", 12v = "Off"
8	GPMH	339	GY	0v	0v/12v	0v/12v	0v/12v	0v/12v	Glow Plug Monitor High Side; 0v = Plugs off, 12v = Plugs on
9	GPMR	1087	O	0v	0v/12v	0v/12v	0v/12v	0v/12v	Glow Plug Monitor Right Bank; 0v = Plugs off, 12v = Plugs on
10	IVS	308	R-O	0v	0v	0v	12v	0v/12v	Idle Validation Switch; 0v = At Idle, 12v = Off Idle
11 ^a	SS2	315	P-O	0v	12v	12v	12v	0v/12v	Shift Solenoid #2; 0v = "On", 12v = "Off"
12 ^a	TCIL	911	W-LG	0v	0v/12v	0v/12v	0v/12v	0v/12v	Trans Control Indicator Light; 0v = Light on, 12v = Light off
13	FEPS	107	P	N/A	N/A	N/A	N/A	N/A	Flash EPROM Power Supply
14 ^{a,b}	4X4L	784	LB-BK	0v	0v/12v	0v/12v	0v/12v	0v/12v	4x4 Low Switch 0v = On, 12v = Off
15	BUS(-)	915	PK-LB	N/A	N/A	N/A	N/A	N/A	Data Link Connector
16	BUS(+)	914	T-O	N/A	N/A	N/A	N/A	N/A	Data Link Connector
17 ^{a,c}	TR1	1012	O-BK	0v	Varies with gear	Varies with gear	Varies with gear	0v/10.7v	P=0v, R=0v, D=10.7v, MAN2=10.7v, MAN1=10.7v
19	TAC	648	W-PK	0v	12v	6.5v/660 Hz	6.5v/660 Hz	130/720 Hz	Tachometer Signal Reflected CMP signal
20 ^a	CCS	924	BR-O	0v	0v	0v	0v	0v/12v	Coast Clutch Solenoid; 0v = "On", 12v = "Off"
21	CMP	795	DG	0v	0.8v	7v	7v	130/720 Hz	Camshaft Position Sensor; 650-3600 RPM
24	APGND	837	Y-BK	0v	0v	0v	0v	0v	Accelerator Pedal Sensor Ground
25	CASE GND	875	BK-LB	0v	0v	0v	0v	0v	Case Ground
29	(Man)	306	T-LB	0v	0v/12v	0v/12v	0v/12v	0v/12v	Clutch Pedal Position Switch (Manual)
30	EBP	224	R-LB	0v	0v/12v	0v/12v	0v/12v	0v/12v	Transmission Control Switch (Automatic)
31	BPA	810	R-LG	0v/12v	0v/12v	0v/12v	0v/12v	0v/12v	Brake Pedal Applied Switch; 0v = Brake on, 12v = Brake off
33	VSS(-)	676	PK-O	0v	0v	0v	0v	0v	Vehicle Speed Sensor Ground
34	GPML	466	PK-O	0v/12v	0v/12v	0v/12v	0v/12v	0v/12v	Glow Plug Monitor Left Bank; 0v = Plugs off, 12v = Plugs on
37 ^a	TFT	923	O-BK	0.2v-0.5v	0.3v-4.5v	0.3v-4.5v	0.3v-4.5v	0.3v-4.5v	Transmission Fluid Temp. 4.5v=40°C/3v=130°C
38	EOT	354	LG-R	0.2v-0.5v	0.3v-4.7v	0.3v-4.7v	0.3v-4.7v	0.3v-4.7v	Engine Oil Temp. 4.7v=40°C/3v=150°F
39	IAT	743	GY	0.2v-0.5v	0.2v-4.5v	0.2v-4.5v	0.2v-4.5v	0.2v-4.5v	Intake Air Temp. 4.5v=40°C/2v=130°F
40	SC.GND	563	O-Y	0v	0v	0v	0v	0v	Speed Control Ground
41	ACC	347	BK-Y	0v	0v/12v	0v/12v	0v/12v	0v/12v	Air Conditioning Clutch; 0v = A/C off, 12v = A/C on
42	EPR	318	GY-R	0v	0v	0v/12v	0v/12v	0v/12v	Exhaust Back Pressure Regulator; Duty cycled, 0v = Off
48	EF	818	GY-W	0v	3v	0.9v-3v	0.9v-3v	0.9v-3v	Electronic Feedback Line, digital 12v frequency
49 ^{a,c}	TR2	146	W-PK	0v	Varies with gear	Varies with gear	Varies with gear	0v/10.7v	P=0v, R=0v, N=10.7v, D=10.7v, MAN2=0v, MAN1=10.7v
50 ^{a,c}	TR4	145	GY-BK	0v	Varies with gear	Varies with gear	Varies with gear	0v/10.7v	P=0v, R=10.7v, N=0v, D=10.7v, MAN2=10.7v, MAN1=0v
51	PWR GND	570A	BK-O	0v	0v	0v	0v	0v	Power Ground
54 ^a	TCC	480	P-Y	12v	12v	12v	12v	0v/12v	Torque Converter Clutch Solenoid; 0v = "On", 12v = "Off"
55	KAPWR	37E	Y	B+	B+	B+	B+	B+	Keep Alive Power; B+ = battery voltage
58	VSS(+)	679	GY-BK	B+	B+	B+	B+	B+	Vehicle Speed Signal
61	SCCS	151	LB-BK	0v	Frequency Signal - Varies with Vehicle Speed	6.6v	6.6v	0v-12v	Cruise Control Command Switch; On=12v, Off=0v, Set=2.8v, Resume=4.7v, Coast=0.8v, Hold=6.6v
63	BARO	356	DB-LG	0v	2v-4.9v	2v-4.9v	2v-4.9v	2v-4.9v	Barometric Pressure Sensor; 4.6v @ 100 kPa (sea level), 2.6v @ 60 kPa (10,000 ft.)
64 ^a	TR3A (E Series)	199	LB-Y	0v	Varies with gear	Varies with gear	Varies with gear	0.7v-4.5v	F-Series: P=4.5v, R=3.7v, N=2.9v, D=2.2v, MAN2=1.4v, MAN1=0.7v
65	CMP GND	796	LB	0v	0v	0v	0v	0v	E-Series: P=0v, R=1.6v, N=1.6v, D=1.6v, MAN2=0v, MAN1=0v
70	GPL	464	BK-PK	0v	0v/12v	12v	12v	0v	Camshaft position sensor ground
71	VPWR	361B	R	0v	B+	B+	B+	B+	Glow Plug Lamp, 0v = Light on, 12v = Light off
76	PWR GND	570B	BK-O	0v	0v	0v	0v	0v	Ignition source power
77	PWR GND	570C	BK-O	0v	0v	0v	0v	0v	Power Ground
80	IDM-EN	814	W-BK	0v	12v -> 0v	0v	0v	0v	IDM Relay; 0v = Relay On, 12v = Relay Off
81 ^a	EPC	814	W-O	0v	8v	10v	12v	8v-12v	Electronic Pressure Control Solenoid
83	IPR	552	Y-R	0v	12v	12v	12v	12v	Injection Pressure Regulator; Duty Cycle Controlled
87	ICP	535	LB-R	0v	0.2v-0.4v	0.7v-1v	1.1v-1.5v	0.6v-3.2v	Injection Control Pressure Sensor (Min 0.88v req. for starting)
88	MAP	358	LG-BK	0v	2.5v	2.5v	2.5v	110-190 Hz	Manifold Absolute Pressure; 110 Hz = Atmospheric Pressure
89	AP	356	GY-W	0.2v-0.5v	0.5v-4v	3.4v-4.2v	3.4v-4.2v	0.5v-4v	Accelerator Pedal Sensor
90	V REF	351	BR-W	0.2v-0.5v	5.0±0.5v	5.0±0.5v	5.0±0.5v	5.0±0.5v	Voltage Reference
91	SIG GND	359	GY-R	0v	0v	0v	0v	0v	Ground for all sensor signals
92	BOO	511	LG	0v/12v	0v/12v	0v/12v	0v/12v	0v/12v	Brake On/Off Switch; 0v = Brake off, 12v = Brake on
95	FDCS	821	BR-O	0v	1v/49 Hz	4v/200 Hz	4v/200 Hz	40 Hz-240 Hz	Fuel Delivery Control Signal; 650-3600 RPM
96	CID	817	Y-LB	0v	6v/30 Hz	7v/30 Hz	7v/30 Hz	5 Hz-30 Hz	Cylinder Identification
97	VPWR	361A	R	B+	B+	B+	B+	B+	Ignition source power
101	GPC	1086	P-O	0v	0v/12v	0v/12v	0v/12v	0v/12v	Glow Plug Control; 0v = (Relay On) 12v = (Relay off)
103	PWR GND	570D	BK-O	0v	0v	0v	0v	0v	Power Ground

a E40D transmission only

b Not used in 1997 Econoline

c Not used on 1997 F-Series

7.3L DI Turbo Diesel Powertrain Control System - 1997 E-Series and California F-Series

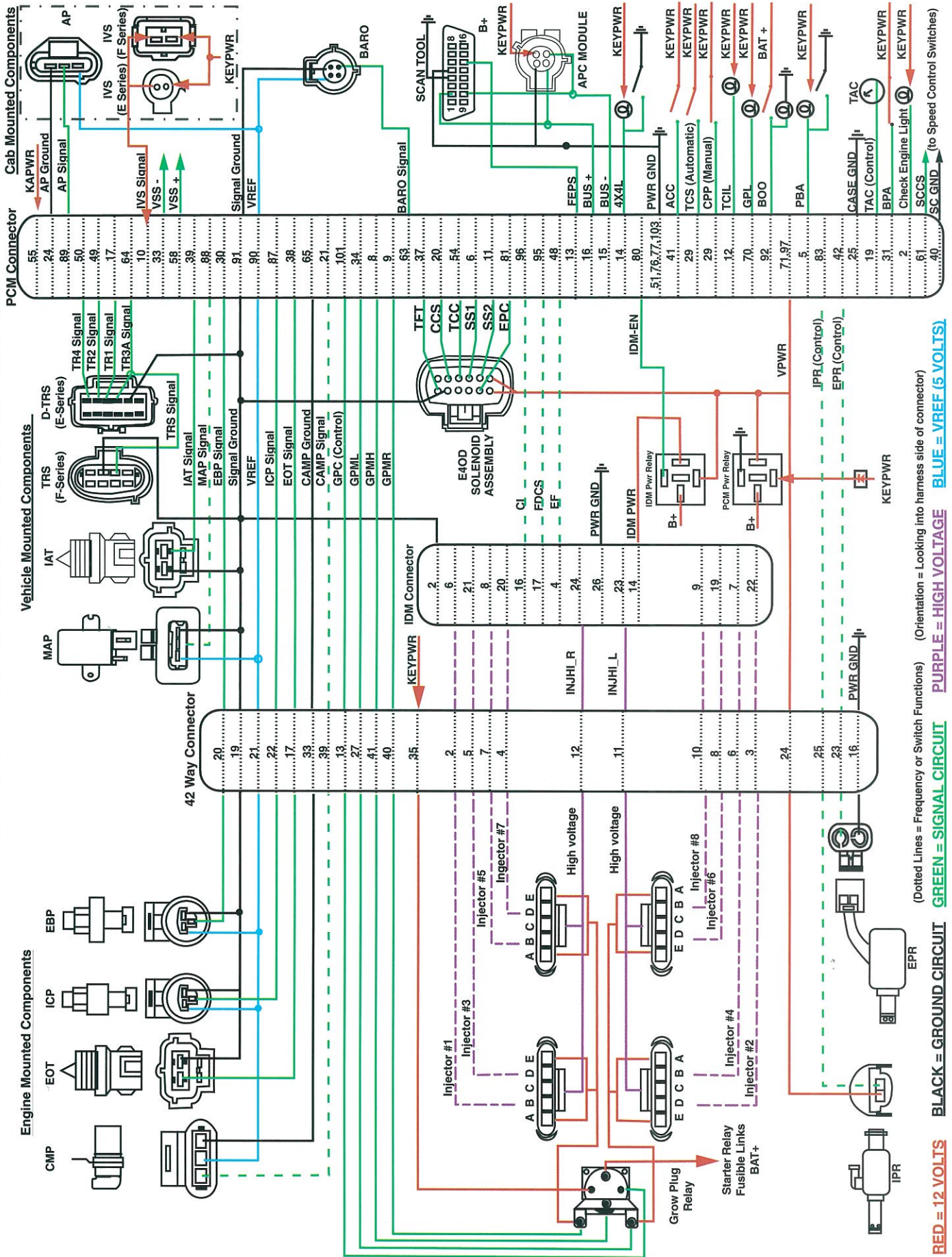

Power Stroke 1997

Econoline (ALL)
F-250/F-350 (California only)

Fault Code	Circuit Index	Condition Description	Comments	Probable Causes
0107*	BARO	Barometric press sensor circuit low input	Defaults to 100 kPa	Open/grounded circuit, biased sensor, PCM
0108*	BARO	Barometric press sensor circuit high input	Defaults to 100 kPa	Circuit shorted to 5V, biased sensor, PCM
0112*	IAT	Intake air temp sensor circuit low input	Defaults to 15°C	Grounded circuit, biased sensor, PCM
0113*	IAT	Intake air temp sensor circuit high input	Defaults to 15°C	Open circuit, biased sensor, PCM, short to 5V
0122*	AP	Accelerator pedal sensor circuit low input	Engine will only idle if hard fault	Grounded circuit, biased sensor, PCM
0123*	AP	Accelerator pedal sensor circuit high input	Engine will only idle if hard fault	Open circuit, biased sensor, PCM, short to 5V
0197*	EOT	Engine oil temp sensor circuit low input	No cold adv., fast low idle	Grounded circuit, biased sensor, PCM
0198*	EOT	Engine oil temp sensor circuit high input	No cold adv., fast low idle	Open circuit, biased sensor, PCM, short to 5V
0220	IVS	Throttle switch B circuit malfunction	Switch test - KOER	Short/open circuit, switch failure, operator, PCM
0221*	AP/IVS	Throttle switch B circuit performance	AP/IVS disagree - Engine will only idle if hard fault	Failed pedal assembly
0236*	MAP	Turbo boost sensor A circuit performance	Uses Inferred MAP signal	Restricted inlet/exhaust/supply hose
0237*	MAP	Turbo boost sensor A circuit low input	Uses Inferred MAP signal	Open, short to ground or 5V, faulty sensor
0238*	MAP	Turbo boost sensor A circuit high input	Uses Inferred MAP signal	Noise, faulty sensor
0261	INJ	Injector circuit low - Cylinder 1	FMEM mode, engine will run on 4 cyl.	Harness short to ground
0262	INJ	Injector circuit high - Cylinder 1	FMEM mode, engine will run on 4 cyl.	Miswired connector or harness
0263	INJ	Cylinder 1 contribution/balance fault	Cylinder not contributing during CCT test	Power cylinder, valve train or injector problem, circuit
0264	INJ	Injector circuit low - Cylinder 2	FMEM mode, engine will run on 4 cyl.	Harness short to ground
0265	INJ	Injector circuit high - Cylinder 2	FMEM mode, engine will run on 4 cyl.	Miswired connector or harness
0266	INJ	Cylinder 2 contribution/balance fault	Cylinder not contributing during CCT test	Power cylinder, valve train or injector problem, circuit
0267	INJ	Injector circuit low - Cylinder 3	FMEM mode, engine will run on 4 cyl.	Harness short to ground
0268	INJ	Injector circuit high - Cylinder 3	FMEM mode, engine will run on 4 cyl.	Miswired connector or harness
0269	INJ	Cylinder 3 contribution/balance fault	Cylinder not contributing during CCT test	Power cylinder, valve train or injector problem, circuit
0270	INJ	Injector circuit low - Cylinder 4	FMEM mode, engine will run on 4 cyl.	Harness short to ground
0271	INJ	Injector circuit high - Cylinder 4	FMEM mode, engine will run on 4 cyl.	Miswired connector or harness
0272	INJ	Cylinder 4 contribution/balance fault	Cylinder not contributing during CCT test	Power cylinder, valve train or injector problem, circuit
0273	INJ	Injector circuit low - Cylinder 5	FMEM mode, engine will run on 4 cyl.	Harness short to ground
0274	INJ	Injector circuit high - Cylinder 5	FMEM mode, engine will run on 4 cyl.	Miswired connector or harness
0275	INJ	Cylinder 5 contribution/balance fault	Cylinder not contributing during CCT test	Power cylinder, valve train or injector problem, circuit
0276	INJ	Injector circuit low - Cylinder 6	FMEM mode, engine will run on 4 cyl.	Harness short to ground
0277	INJ	Injector circuit high - Cylinder 6	FMEM mode, engine will run on 4 cyl.	Miswired connector or harness
0278	INJ	Cylinder 6 contribution/balance fault	Cylinder not contributing during CCT test	Power cylinder, valve train or injector problem, circuit
0279	INJ	Injector circuit low - Cylinder 7	FMEM mode, engine will run on 4 cyl.	Harness short to ground
0280	INJ	Injector circuit high - Cylinder 7	FMEM mode, engine will run on 4 cyl.	Miswired connector or harness
0281	INJ	Cylinder 7 contribution/balance fault	Cylinder not contributing during CCT test	Power cylinder, valve train or injector problem, circuit
0282	INJ	Injector circuit low - Cylinder 8	FMEM mode, engine will run on 4 cyl.	Harness short to ground
0283	INJ	Injector circuit high - Cylinder 8	FMEM mode, engine will run on 4 cyl.	Miswired connector or harness
0284	INJ	Cylinder 8 contribution/balance fault	Cylinder not contributing during CCT test	Power cylinder, valve train or injector problem, circuit
0340	CMP	Camshaft position sensor ckt malfunction	No CMP sensor signal detected during crank	Open/grounded circuit, sensor fault, short to power
0341*	CMP	Camshaft position sensor ckt performance	Electrical noise detected	Harness routing, charging circuit, sensor
0344*	CMP	Camshaft position sensor ckt intermittent	Incorrect number of CMP transition counts	Harness routing, charging ckt, sensor, int ckt, improper gap
0380*	GPC	Glow plug circuit malfunction	Continuous and KOEO on-demand test	Open/grounded ckt, solenoid open/shorted, failed PCM
0381*	GPL	Glow plug indicator circuit malfunction	Continuous and KOEO on-demand test	Open/grounded circuit, lamp open, failed PCM
0470	EBP	Exhaust press sensor circuit malfunction	No-start or crank mode	Biased sensor, open signal return
0471*	EBP	Exhaust press sensor circuit performance	Continuous	Plugged, stuck, or leaking hose
0472*	EBP	Exhaust press sensor circuit low input	Disables back pressure device	Open/grounded circuit, biased sensor, PCM
0473*	EBP	Exhaust press sensor circuit high input	Disables back pressure device	Circuit shorted to 5V, biased sensor, PCM
0475*	EPR	Exhaust press control valve malfunction	Continuous & KOEO on-demand test	Open/grounded ckt, solenoid open/shorted, failed PCM
0476	EPR	Exhaust press control valve performance	KOER on-demand test	Failed/stuck EPR, EBP fault, EPR circuit
0478*	EPR	Exhaust press control valve high input	Excessive back pressure - Continuous	Plugged sensor line, stuck butterfly, restricted exhaust
0500*	VSS	Vehicle speed sensor malfunction	Continuous	Sensor, circuit, PCM, PSOM, low trans fluid
0560	N/A	System voltage malfunction	B+ too low for KOER on-demand or CCT test - aborts test	Charging system problem/load, glow plugs still enabled
0562*	VPWR	System voltage low	May be temporary condition at crank only	Low sys voltage, charging sys, internal PCM failure
0563	VPWR	System voltage high	May be temporary condition - 24V jump start	High sys voltage, charging sys, internal PCM failure
0565	SCCS	Cruise On signal malfunction	KOER switch test (Code set if cruise not present)	Open or short circuit, switch failure, PCM failure or failed to activate switch during KOER switch test
0566	SCCS	Cruise Off signal malfunction	KOER switch test (Code set if cruise not present)	
0567	SCCS	Cruise Resume signal malfunction	KOER switch test (Code set if cruise not present)	
0568	SCCS	Cruise Set signal malfunction	KOER switch test (Code set if cruise not present)	
0569	SCCS	Cruise Coast signal malfunction	KOER switch test (Code set if cruise not present)	
0571	BPA	Brake switch A circuit malfunction	KOER switch test (Code set if cruise not present)	Cruise control and BPA codes will be set on every switch test on vehicles not equipped with cruise control.
0603	PCM	Powertrain Control Module KAM test error	No historical faults output during self test	Open PCM pin, disconnected B+, faulty PCM
0605	PCM	Powertrain Control Module ROM test error	Internal PCM failure	Internal PCM failure
0606	PCM	PCM processor fault	PCM inactive background fault	Internal PCM failure
0703	BOO	Brake switch B circuit malfunction	KOER switch test	Open/short circuit, switch, PCM, failed to activate switch during KOER switch test
0704	CPP	Clutch switch input circuit malfunction	KOER switch test	
0705*	TRS	Trans range sensor circuit malfunction	Continuous	Short or open digital TRS (pin 64 short only)
0707*	TRS	Trans range sensor circuit low input	Continuous	Short to ground Analog TRS
0708*	TRS	Trans range sensor circuit high input	Continuous	Open analog TRS, open pin 64 digital TRS
0712	TFT	Trans fluid temp sensor ckt low input	KOEO, KOER, and Continuous	Short to ground, biased sensor, PCM
0713	TFT	Trans fluid temp sensor ckt high input	KOEO, KOER, and Continuous	Open circuit, biased sensor, PCM, short to power
0741	TCC	Torque converter clutch ckt performance	Continuous	Faulty solenoid, PCM, convertor hydraulic system
0743*	TCC	Torque converter clutch system electrical	KOEO and Continuous	Faulty solenoid, PCM
0750*	SS1	Shift solenoid A malfunction	KOEO and Continuous	Circuit failure, faulty solenoid, PCM
0755*	SS2	Shift solenoid B malfunction	KOEO and Continuous	Circuit failure, faulty solenoid, PCM
0782	N/A	2-3 shift error	Continuous	Circuit failure, faulty solenoid, faulty clutch, PCM
0783	N/A	3-4 shift error	Continuous	Circuit failure, faulty solenoid, faulty clutch, PCM

POWERTRAIN CONTROL SYSTEM ELECTRONICS DIAGNOSTIC GUIDE

Fault Code	Circuit Index	Condition Description	Comments	Probable Causes
1000	N/A	Check of all OBDII systems not complete		
1184	EOT	Engine oil temp sensor out of self test range	Engine not warm enough to run KOER CCT - aborts test	Engine not warm enough, leaking thermostat, ckt failure
1209*	IPR	Injection control pressure system fault		IPR valve stuck
1210*	IPR	Injection control pressure above expected level	No-start mode and KOEO on-demand test	
1211*	IPR	ICP pressure above/below desired	Continuous and KOER on-demand test	IPR valve failed, stuck, or shorted to ground
1212	ICP	ICP press not detected during crank	Crank only	Biased sensor or ckt, open signal return, low oil in reservoir
1218	CI	CI stuck high	Cylinder identification line stuck high	CI circuit open, probably intermittent
1219	CI	CI stuck low	Cylinder identification line stuck low	CI circuit short to ground, probably intermittent
1247*	MAP	Turbo boost pressure low		
1248*	MAP	Turbo boost pressure not detected		Hose disconnected
1261-1268	INJ	High to low side short cyl#1 - #8	Cylinder with fault will not operate	Short circuit, shorted injector, failed IDM
1271-1278	INJ	High to low side open cyl#1 - #8	Cylinder with fault will not operate	Open circuit, open injector, failed IDM
1280*	ICP	ICP circuit out of range low	Uses inferred ICP strategy	Open/grounded circuit, biased sensor, PCM
1281*	ICP	ICP circuit out of range high	Uses inferred ICP strategy	Circuit shorted to 5V, biased sensor, PCM
1282*	IPR	Excessive ICP pressure	System fault	Faulty IPR regulator (sticking), IPR shorted to ground
1283	IPR	IPR circuit failure	Continuous & KOEO on-demand test	Open/grounded circuit, stuck IPR, loose connection
1284	N/A	ICP failure - aborts KOER test	Aborts KOER CCT and on-demand tests See codes 1280, 1281, 1282, 1283, 1211	Sensor circuit fault
1291	INJ	High side short to grd or B+, bank #1 (right)	Inj power supply circuit short (operates on 4 cylinders)	Shorted circuit, faulty IDM
1292	INJ	High side short to grd or B+, bank #2 (left)	Inj power supply circuit short (operates on 4 cylinders)	Shorted circuit, faulty IDM
1293	INJ	High side open bank #1 (right)	Inj power supply circuit open (operates on 4 cylinders)	Open circuit, faulty IDM
1294	INJ	High side open bank #2 (left)	Inj power supply circuit open (operates on 4 cylinders)	Open circuit, faulty IDM
1295	INJ	Multiple faults on bank #1 (right) with low side short	Fix low side short and rerun diagnostics	Miswired connector or harness, short to ground
1296	INJ	Multiple faults on bank #2 (left) with low side short	Fix low side short and rerun diagnostics	Miswired connector or harness, short to ground
1297	INJ	High sides shorted together	Fix shorts and rerun diagnostics	Shorted wires, faulty IDM
1298	IDM	IDM failure	Internal IDM failure	Internal IDM failure
1316*	IDM	Injector circuit/IDM codes detected	Run KOEO on-demand test to retrieve codes	Injector circuit/IDM codes detected
1391*	GPM	Glow plug circuit low input, bank #1 (right)	Aborts glow plug monitoring	Open circuit, short to power or ground, faulty relay
1393*	GPM	Glow plug circuit low input, bank #2 (left)	Aborts glow plug monitoring	Open circuit, short to power or ground, faulty relay
1395*	GPM	Glow plug monitor fault, bank #1	Continuous & KOER glow plug monitor test	One or more glow plugs failed
1396*	GPM	Glow plug monitor fault, bank #2	Continuous & KOER glow plug monitor test	One or more glow plugs failed
1397	VPWR	System voltage out of self test range	Aborts KOER glow plug monitor test	System voltage too high or low for glow plug monitor test
1464	N/A	A/C demand out of self test range	Aborts KOER CCT test	Operator error, A/C circuit shorted to power
1501	N/A	VSS out of self test range	Aborts test - KOER on-demand, CCT, or switch test	Operator error
1502	N/A	Invalid test - APCM functioning	Aborts test - KOER on-demand, CCT, or switch test	APCM active while KOER test is running
1531	N/A	Invalid test - accelerator pedal movement	Aborts test - KOER on-demand or CCT test	Operator error
1536	PBA	Parking brake switch circuit failure	KOER switch test	Failed to activate switch during test, circuit, switch, PCM
1660	OCC	OCC signal high	Aborts KOEO on-demand test	High system voltage, internal PCM fault
1661	OCC	OCC signal low	Aborts KOEO on-demand test	Low system voltage, internal PCM fault
1662	IDM_EN	IDM_EN circuit failure	Continuous & KOEO on-demand test	Open IDM relay, blown fuse, open/grounded circuit
1663	FDCS	FDCS circuit failure	Fuel demand command signal - KOEO on-demand test	Open/grounded circuit, faulty IDM
1667	CI	CI circuit failure	Cylinder identification circuit - KOEO on-demand test	Open/grounded circuit, faulty IDM
1668	EF	PCM-IDM diagnostic communication error	Electronic feedback line - KOEO on-demand test	Open/shorted EF or FDCS, open IDM ground
1670*	EF	EF signal not detected	Continuous	Open/shorted EF circuit
1704	TRS	Digital TRS failed to transition state	KOEO only	Sensor, wiring, PCM, mechanical alignment
1705	TRS	TR sensor out of self test range	Not in PARK during KOEO or KOER	Operator error, circuit failure, faulty sensor, PCM
1711	TFT	TFT sensor out of self test range	Transmission fluid temp too high or low for KOEO or KOER test/circuit failure, faulty sensor, PCM	Transmission too hot or cold,
1714*	SS1	Shift Solenoid 1 inductive signature malfunction	Continuous	Solenoid or PCM
1715*	SS2	Shift Solenoid 2 inductive signature malfunction	Continuous	Solenoid or PCM
1728	TCC	Transmission slip error	Continuous	Solenoid failure or mechanical failure
1729	4x4L	4x4 Low switch error	Continuous	Circuit failure, faulty switch, PCM
1740*	TCC	Torque converter clutch inductive sig malfunction	Continuous	Solenoid or PCM
1746	EPC	EPC solenoid open circuit	Continuous	Open circuit, faulty solenoid, PCM
1747*	EPC	EPC solenoid short circuit	Continuous	Short circuit, faulty solenoid, PCM shorted to ground
1754	CCS	Coast clutch solenoid circuit malfunction	Continuous & KOEO on-demand test	Circuit failure, faulty solenoid, PCM
1780	TCS	TCS circuit out of self test range	KOER switch test	Circuit, switch, PCM, failed to activate switch or switch always active during KOER
1781	4X4L	4X4L circuit out of self test range	In 4X4L during KOEO	Operator error, short to ground, PCM
1783	TFT	Transmission overtemperature condition	Continuous	Internal transmission failure, circuit failure, sensor, PCM

* (OBDII) MIL illumination occurs after 2nd consecutive fault

(FMEM) MIL illumination occurs after 1st fault

Transmission Control Indicator Light (TCIL) flashes when fault is present.

TCIL illuminates on 49 state applications only

**For F-250/F-350 (49 state) and F-Super Duty (ALL)
refer to Diagnostic Guide #FCS-70230208**

**7.3L Diesel Pin Out Values — 1997
F-250/F-350 (49 state only) and ALL F-Super Duty (49 state and California)**

Pin #	Name	Circuit #	Wire Color	Key Off	Key On	Low Idle	High Idle	Operating Range	Comments
1 ^a	SS2	315	P-O	0v	12v	12v	12v	0v/12v	Shift Solenoid #2 0v = "On", 12v = "Off"
2	Check Engine Light	658	PK-LG	0v	B+	B+	B+	B+	0v=Light On, 12v=Light Off
4 ^b	PBA	977D	P-W	0v	12v/0v	12v/0v	12v/0v	12v/0v	Parking Brake Applied Switch "Up/Down"
5	IVS	308	R-O	0v	0v/12v	0v	12v	0v/12v	Idle Validation Switch "Up/Down"; Open at idle
13	FEPS	107	P	N/A	N/A	N/A	N/A	N/A	Flash EPROM Power Supply
14 ^a	4X4L	784	LB-BK	0v	12v/0v	12v/0v	12v/0v	12v/0v	4x4 Low Switch 12v = "Off", 0v = "On"
15	BUS(-)	915	PK-LB	N/A	N/A	N/A	N/A	N/A	Data Link Connector
16	BUS(+)	914	T-O	N/A	N/A	N/A	N/A	N/A	Data Link Connector
25	CASE GND	57Z	BK	0v	0v	0v	0v	0v	Case Ground
27 ^a	SS1	237	O-Y	0v	0v	0v	0v	0v/12v	Shift Solenoid #1 0v = "On", 12v = "Off"
28 ^a	TCC	480	P-Y	0v	12v	12v	12v	0v/12v	Converter Clutch Solenoid 0v = "On", 12v = "Off"
29	(Manl)	306	T-LB	0v	12v/0v	12v/0v	12v/0v	12v/0v	Clutch Pedal Position Switch (Manual)
	TCS(Auto)	254	T-W	0v	12v/0v	12v/0v	12v/0v	12v/0v	Transmission Control Switch (Automatic)
30	EBP	553	P-LB	0v	.8v-.95v	.8v-.95v	1.25v-1.75v	.8v-3v	Exhaust Back Pressure Sensor
31 ^c	BPA	307	BK-Y	0v	12v/0v	12v/0v	12v/0v	12v/0v	Brake Pedal Applied "Up/Down"
33	VSS(-)	676	PK-O	0v	0v	0v	0v	0v	Vehicle Speed Sensor Ground
34	MAP	358	LG-BK	0v	.2v-.5v	2.5v	2.5v	110-186 Hz	Manifold Pressure 110/113 Hz = At. Press.
37 ^a	TFT	923	O-BK	0v	.3v-4.5v	.3v-4.5v	.3v-4.5v	.46v=212°F	Transmission Fluid Temp. 4.5v=40°F/.3v=230°F
38	EOT	354	LG-R	0v	.35v-4.5v	.35v-4.5v	.35v-4.5v	.75v=212°F	Engine Oil Temp. 4.7v=40°F/.68v=230°F
39	IAT	743	GY	0v	.35v-4.5v	.35v-4.5v	.35v-4.5v	3.07v=68°F	Intake Air Temp. 4.53v=40°F/.358v=230°F
40 ^d	SC GND	848	DG-O	0v	0v	0v	0v	0v	Speed Control Ground
41 ^{a,e}	ACC	198	DG-O	0v	12v/0v	12v/0v	12v/0v	12v/0v	Air Conditioning Clutch 12v = "On", 0v = "Off"
42	EPR	318	GY-R	0v	6v-8v	6v-8v	0v	0v-10v	Exhaust Back Pressure Volt. only when enabled
48	EF	818	GY-W	0v	3.3v avg.	4v-2.2v	1.9v-2.2v	.4v-2.2v	Electronic Feedback Line, digital 12v frequency
49	CMP	795	DG	0v	12v/2.5v	7v	7v	130-720 Hz	Camshaft Position Sensor 650-3600 RPM
50 ^g	TAC	648	W-PK	0v	12v	6.5v/130 Hz	6.5v/660 Hz	130-720 Hz	Tachometer Signal Reflected CMP Signal
51	PWR GND	570A	BK-W	0v	0v	0v	0v	0v	Power Ground
53 ^a	CCS	924	BR-O	0v	0v	0v	0v	0v/12v	Coast Clutch Solenoid 0v = "On", 12v = "Off"
55	KAPWR	37E	Y	B+	B+	B+	B+	B+	Keep Alive Power B+ = battery voltage
58	VSS(+)	679	GY-BK	B+	B+	B+	B+	B+	Vehicle Speed Signal
61	SCCS	151	LB-BK	0v	0v to 12v	0v to 12v	0v to 12v	0v to 12v	Cruise Cntl. Voltage will vary with switch position
64 ^a	TR	199	LB-Y	0v	4.5v	4.5v	4.5v	0v-4.5v	Transmission Range Sensor P = 4.5v, R = 3.7v, N = 2.9v, D = 2.2v, MAN2 = 1.4v, MAN1 = .7v
65	CMP GND	796	LB	0v	0v	0v	0v	0v	Camshaft position sensor ground
70	IDM_LEN	814	W-BK	0v	12v -> 0v	0v	0v	12v/0v	IDM Relay 12v = IDM Off 0v = IDM On
71	VPWR	361B	R	0v	B+	B+	B+	B+	Ignition source pwr.
76	PWR GND	570B	BK-W	0v	0v	0v	0v	0v	Power Ground
77	PWR GND	570C	BK-W	0v	0v	0v	0v	0v	Power Ground
79 ^a	TCIL	911	W-LG	0v	12v/0v	12v/0v	12v/0v	12v/0v	Trans Control Indicator Light 12v = "Off", 0v = "On"
80	GPL	464	BK-PK	0v	0v/12v	12v	12v	0v/12v	Glow Plug Lamp 0v = Light On, 12v = Light Off
81 ^a	EPC	925	W-Y	0v	4.5v	7.5v	12v	7.5v-12v	Electronic Pressure Control Solenoid
83	IPR	552	Y-R	0v	0v	12v	12v	12v	Injection Pressure Reg. Duty Cycle Controlled
84	BARO	356	DB-LG	.75v-3v	.75v-4.9v	.75v-4.9v	.75v-4.9v	.75v-4.9v	4.64v at 100 kPa (sea level) 2.6v at 60 kPa (10,000 ft.)
87 ⁱ	ICP	812	DB-LG	0v	.25v-.4v	.75v-1v	1.1v-1.5v	.65v-3.25v	Injection Control Pressure (Min. .83v req. for starting)
89	AP	355	GY-W	0v	.5v-4v	.5v-.9v	3.8v-4.2v	.5v-4v	Accelerator Pedal Sensor
90	V REF	351	BR-W	.41v	5.0±.5v	5.0±.5v	5.0±.5v	5.0±.5v	Voltage Reference
91	SIG GRD	359	GY-R	0v	0v	0v	0v	0v	Ground for all sensor signals
92	BOO	511	LG	0v/12v	0v/12v	0v/12v	0v/12v	0v/12v	Brake On/Off Switch "Up/Down"
95	FDGS	821	BR-O	0v	.5v	1v-49 Hz	2.7v/200 Hz	43/240 Hz	Fuel Delivery Control Signal 650-3600 RPM
96	CID	817	Y-LB	0v	.5v	6v/5 Hz	6v/720 Hz	5 Hz-720 Hz	Cylinder Identification
97	VPWR	361A	R	0v	B+	B+	B+	B+	Ignition source pwr.
101	GPC	1086	P-O	0v	0v/12v	0v/12v	12v	0v/12v	Glow Plug Cntrl. 0v=(GP relay On) 12v=(GP relay off)
103	PWR GND	570D	BK-W	0v	0v	0v	0v	0v	Power Ground

a E40D transmission only
b 162 (LGR) for Econoline applications
c 810 (R/LG) for Econoline applications

d 563 (O/Y) for Econoline applications
e 347 (BK/Y) for Econoline applications
f 535 (LB/R) for Econoline applications

g Not used on Econoline applications

7.3L DI Turbo Diesel Powertrain Control System - All 1997 F-series except California

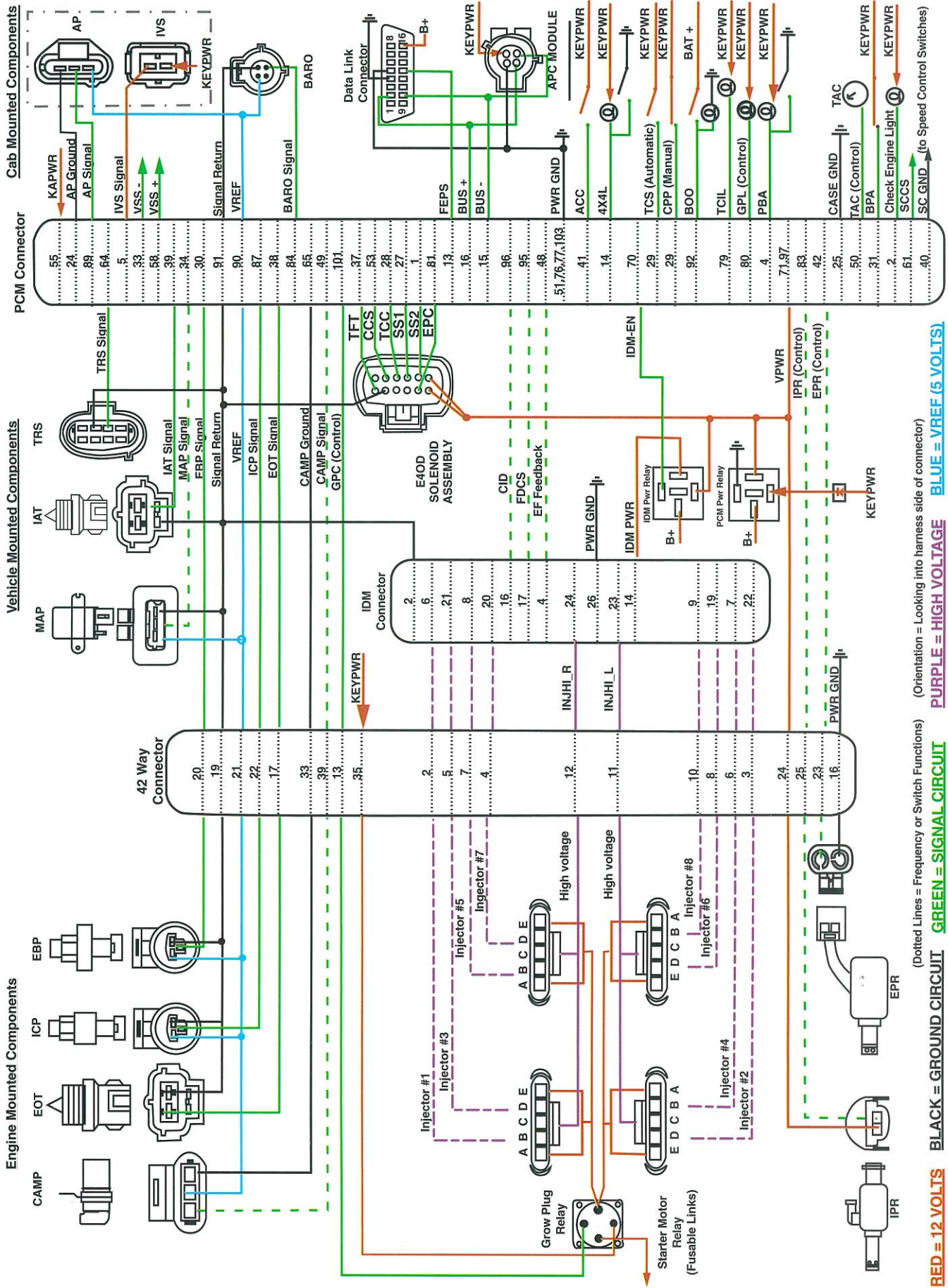

(Dotted Lines = Frequency or Switch Functions) (Orientation = Looking into harness side of connector)
RED = 12 VOLTS **BLACK = GROUND CIRCUIT** **GREEN = SIGNAL CIRCUIT** **PURPLE = HIGH VOLTAGE** **BLUE = VREF (5 VOLTS)**

Power Stroke 1997

F-250/F-350 (49 state)
F-Super Duty (ALL)

Fault Code	Circuit Index	Condition Description	Comments	Probable Causes
0107	BARO	Barometric press sensor circuit low input	Defaults to 100 kPa	Open/grounded circuit, biased sensor, PCM
0108	BARO	Barometric press sensor circuit high input	Defaults to 100 kPa	Circuit shorted to 5V, biased sensor, PCM
0112	IAT	Intake air temp sensor circuit low input	Defaults to 15°C	Grounded circuit, biased sensor, PCM
0113	IAT	Intake air temp sensor circuit high input	Defaults to 15°C	Open circuit, biased sensor, PCM, short to 5V
0122	AP	Accelerator pedal sensor circuit low input	Engine will only idle if hard fault	Grounded circuit, biased sensor, PCM
0123	AP	Accelerator pedal sensor circuit high input	Engine will only idle if hard fault	Open circuit, biased sensor, PCM, short to 5V
0196	EOT	Engine oil temp sensor circuit performance	Engine not warm enough to run KOER CCT - aborts test	Engine not warm enough, leaking thermostat, ckt failure
0197	EOT	Engine oil temp sensor circuit low input	No cold adv., fast low idle	Grounded circuit, biased sensor, PCM
0198	EOT	Engine oil temp sensor circuit high input	No cold adv., fast low idle	Open circuit, biased sensor, PCM, short to 5V
0220	IVS	Throttle switch B circuit malfunction	Switch test - KOER	Short/open circuit, switch failure, operator, PCM
0221	AP/IVS	Throttle switch B circuit performance	AP/IVS disagree - Engine will only idle if hard fault	Failed pedal assembly
0236	MAP	Turbo boost sensor A circuit performance	Uses Inferred MAP signal	Restricted inlet/exhaust/supply hose or missing hose
0237	MAP	Turbo boost sensor A circuit low input	Uses Inferred MAP signal	Open, short to ground or 5V, faulty sensor
0238	MAP	Turbo boost sensor A circuit high input	Uses Inferred MAP signal	Noise, faulty sensor
0261	INJ	Injector circuit low - Cylinder 1	FMEM mode, engine will run on 4 cyl.	Harness short to ground
0262	INJ	Injector circuit high - Cylinder 1	FMEM mode, engine will run on 4 cyl.	Miswired connector or harness
0263	INJ	Cylinder 1 contribution/balance fault	Cylinder not contributing during CCT test	Power cylinder, valve train or injector problem, circuit
0264	INJ	Injector circuit low - Cylinder 2	FMEM mode, engine will run on 4 cyl.	Harness short to ground
0265	INJ	Injector circuit high - Cylinder 2	FMEM mode, engine will run on 4 cyl.	Miswired connector or harness
0266	INJ	Cylinder 2 contribution/balance fault	Cylinder not contributing during CCT test	Power cylinder, valve train or injector problem, circuit
0267	INJ	Injector circuit low - Cylinder 3	FMEM mode, engine will run on 4 cyl.	Harness short to ground
0268	INJ	Injector circuit high - Cylinder 3	FMEM mode, engine will run on 4 cyl.	Miswired connector or harness
0269	INJ	Cylinder 3 contribution/balance fault	Cylinder not contributing during CCT test	Power cylinder, valve train or injector problem, circuit
0270	INJ	Injector circuit low - Cylinder 4	FMEM mode, engine will run on 4 cyl.	Harness short to ground
0271	INJ	Injector circuit high - Cylinder 4	FMEM mode, engine will run on 4 cyl.	Miswired connector or harness
0272	INJ	Cylinder 4 contribution/balance fault	Cylinder not contributing during CCT test	Power cylinder, valve train or injector problem, circuit
0273	INJ	Injector circuit low - Cylinder 5	FMEM mode, engine will run on 4 cyl.	Harness short to ground
0274	INJ	Injector circuit high - Cylinder 5	FMEM mode, engine will run on 4 cyl.	Miswired connector or harness
0275	INJ	Cylinder 5 contribution/balance fault	Cylinder not contributing during CCT test	Power cylinder, valve train or injector problem, circuit
0276	INJ	Injector circuit low - Cylinder 6	FMEM mode, engine will run on 4 cyl.	Harness short to ground
0277	INJ	Injector circuit high - Cylinder 6	FMEM mode, engine will run on 4 cyl.	Miswired connector or harness
0278	INJ	Cylinder 6 contribution/balance fault	Cylinder not contributing during CCT test	Power cylinder, valve train or injector problem, circuit
0279	INJ	Injector circuit low - Cylinder 7	FMEM mode, engine will run on 4 cyl.	Harness short to ground
0280	INJ	Injector circuit high - Cylinder 7	FMEM mode, engine will run on 4 cyl.	Miswired connector or harness
0281	INJ	Cylinder 7 contribution/balance fault	Cylinder not contributing during CCT test	Power cylinder, valve train or injector problem, circuit
0282	INJ	Injector circuit low - Cylinder 8	FMEM mode, engine will run on 4 cyl.	Harness short to ground
0283	INJ	Injector circuit high - Cylinder 8	FMEM mode, engine will run on 4 cyl.	Miswired connector or harness
0284	INJ	Cylinder 8 contribution/balance fault	Cylinder not contributing during CCT test	Power cylinder, valve train or injector problem, circuit
0340	CMP	Camshaft position sensor ckt malfunction	No CMP sensor signal detected during crank	Open/grounded circuit, sensor fault, short to power
0341	CMP	Camshaft position sensor ckt performance	Electrical noise detected	Harness routing, charging circuit, sensor
0344	CMP	Camshaft position sensor ckt intermittent	Incorrect number of CMP transition counts	Harness routing, charging ckt, sensor, int ckt, improper gap
0380	GPC	Glow plug circuit malfunction	Glow Plug Relay - KOEO on-demand test	Open/grounded ckt, solenoid open/shorted, failed PCM
0381	GPL	Glow plug indicator circuit malfunction	Glow Plug Lamp - KOEO on-demand test	Open/grounded circuit, lamp open, failed PCM
0470	EBP	Exhaust press sensor circuit malfunction	Key-on or crank mode	Biased sensor, open signal return
0471	EBP	Exhaust press sensor circuit performance	Continuous	Plugged, stuck, or leaking hose
0472	EBP	Exhaust press sensor circuit low input	Disables back pressure device	Open/grounded circuit, biased sensor, PCM
0473	EBP	Exhaust press sensor circuit high input	Disables back pressure device	Circuit shorted to 5V, biased sensor, PCM
0475	EPR	Exhaust press control valve malfunction	Exhaust back press reg - KOEO on-demand test	Open/grounded ckt, solenoid open/shorted, failed PCM
0476	EPR	Exhaust press control valve performance	KOER on-demand test	Failed/stuck EPR, EBP fault, EPR circuit
0478	EPR	Exhaust press control valve high input	Excessive back pressure - Continuous	Plugged sensor line, stuck butterfly, restricted exhaust
0500	VSS	Vehicle speed sensor malfunction	Continuous	Sensor, circuit, PCM, PSOM, low trans fluid
0560	N/A	System voltage malfunction	B+ too low for KOER on-demand or CCT test - aborts test	Charging system problem/load, glow plugs still enabled
0562	VPWR	System voltage low	May be temporary condition at crank only	Low sys voltage, charging sys, internal PCM failure
0563	VPWR	System voltage high	May be temporary condition - 24V jump start	High sys voltage, charging sys, internal PCM failure
0565	SCCS	Cruise On signal malfunction	KOER switch test (Code set if cruise not present)	Open or short circuit, switch failure, PCM failure or failed to activate switch during KOER switch test*
0566	SCCS	Cruise Off signal malfunction	KOER switch test (Code set if cruise not present)	
0567	SCCS	Cruise Resume signal malfunction	KOER switch test (Code set if cruise not present)	
0568	SCCS	Cruise Set signal malfunction	KOER switch test (Code set if cruise not present)	
0569	SCCS	Cruise Coast signal malfunction	KOER switch test (Code set if cruise not present)	
0571	BPA	Brake switch A circuit malfunction	KOER switch test (Code set if cruise not present)	
0603	PCM	Powertrain Control Module KAM test error	No historical faults output during self test	Open PCM pin, disconnected B+, faulty PCM
0605	PCM	Powertrain Control Module ROM test error	Internal PCM failure	Internal PCM failure
0606	PCM	PCM processor fault	PCM inactive background fault	Internal PCM failure
0703	BOO	Brake switch B circuit malfunction	KOER switch test	Open/short circuit, switch, PCM, failed to activate switch during KOER switch test
0704	CPP	Clutch switch input circuit malfunction	KOER switch test	
0707	TRS	Trans range sensor circuit low input	Continuous	Short to ground in circuit, biased sensor, PCM
0708	TRS	Trans range sensor circuit high input	Continuous	Open in circuit, biased sensor, PCM, short to power
0712	TFT	Trans fluid temp sensor ckt low input	KOEO, KOER, and Continuous	Short to ground, biased sensor, PCM
0713	TFT	Trans fluid temp sensor ckt high input	KOEO, KOER, and Continuous	Open circuit, biased sensor, PCM, short to power
0741	TCC	Torque converter clutch ckt performance	KOEO only	Circuit failure, faulty solenoid, PCM
0750	SS1	Shift solenoid A malfunction	KOEO only	Circuit failure, faulty solenoid, PCM
0755	SS2	Shift solenoid B malfunction	KOEO only	Circuit failure, faulty solenoid, PCM
0782	N/A	2-3 shift error	Continuous	Circuit failure, faulty solenoid, faulty clutch, PCM
0783	N/A	3-4 shift error	Continuous	Circuit failure, faulty solenoid, faulty clutch, PCM
1111	N/A	System pass	No PCM system faults detected	N/A
1211	IPR	ICP pressure above/below desired	Continuous and KOER on-demand test	IPR valve failed, stuck, or shorted to ground
1212	ICP	ICP volt not at expected level	Crank mode and KOEO on-demand test	Biased sensor or ckt, open signal return, low oil in reservoir

POWERTRAIN CONTROL SYSTEM ELECTRONICS DIAGNOSTIC GUIDE

Fault Code	Circuit Index	Condition Description	Comments	Probable Causes
1218	CI	CI stuck high	Cylinder identification line stuck high	CI circuit open, probably intermittent
1219	CI	CI stuck low	Cylinder identification line stuck low	CI circuit short to ground, probably intermittent
1261-1268	INJ	High to low side short cyl#1 - #8	Cylinder with fault will not operate	Short circuit, shorted injector, failed IDM
1271-1278	INJ	High to low side open cyl#1 - #8	Cylinder with fault will not operate	Open circuit, open injector, failed IDM
1280	ICP	ICP circuit out of range low	Uses inferred ICP strategy	Open/grounded circuit, biased sensor, PCM
1281	ICP	ICP circuit out of range high	Uses inferred ICP strategy	Circuit shorted to 5V, biased sensor, PCM
1282	IPR	Excessive ICP pressure	System fault	Faulty IPR regulator (sticking), IPR shorted to ground
1283	IPR	IPR circuit failure	KOEO on-demand test	Open/grounded circuit, stuck IPR, loose connection
1284	N/A	ICP failure - aborts KOER test	Aborts KOER CCT test	Sensor circuit fault See codes 1280, 1281, 1282, 1283, 1211
1291	INJ	High side short to grd or B+, bank #1 (right)	Inj power supply circuit short (operates on 4 cylinders)	Shorted circuit, faulty IDM
1292	INJ	High side short to grd or B+, bank #2 (left)	Inj power supply circuit short (operates on 4 cylinders)	Shorted circuit, faulty IDM
1293	INJ	High side open bank #1 (right)	Inj power supply circuit open (operates on 4 cylinders)	Open circuit, faulty IDM
1294	INJ	High side open bank #2 (left)	Inj power supply circuit open (operates on 4 cylinders)	Open circuit, faulty IDM
1295	INJ	Multiple faults on bank #1 (right) with low side short	Fix low side short and rerun diagnostics	Miswired connector or harness, short to ground
1296	INJ	Multiple faults on bank #2 (left) with low side short	Fix low side short and rerun diagnostics	Miswired connector or harness, short to ground
1297	INJ	High sides shorted together	Fix shorts and rerun diagnostics	Shorted wires, faulty IDM
1298	IDM	IDM failure	Internal IDM failure	Internal IDM failure
1464	N/A	A/C demand out of self test range	Aborts test - KOER on-demand, CCT, or switch test	Operator error, A/C circuit shorted to power
1501	N/A	VSS out of self test range	Aborts test - KOER on-demand, CCT, or switch test	Operator error
1502	N/A	Invalid test - APCM functioning	Aborts test - KOER on-demand, CCT, or switch test	APCM active while KOER test is running
1531	N/A	Invalid test - accelerator pedal movement	Aborts test - KOER on-demand or CCT test	Operator error
1536	PBA	Parking brake switch circuit failure	KOER switch test	Failed to activate switch during test, circuit, switch, PCM
1660	OCC	OCC signal high	Aborts KOEO on-demand test	High system voltage, internal PCM fault
1661	OCC	OCC signal low	Aborts KOEO on-demand test	Low system voltage, internal PCM fault
1662	IDM_EN	IDM_EN circuit failure	KOEO on-demand test	Open IDM relay, blown fuse, open/grounded circuit
1663	FDCS	FDCS circuit failure	Fuel demand command signal - KOEO on-demand test	Open/grounded circuit, faulty IDM
1667	CI	CI circuit failure	Cylinder identification circuit - KOEO on-demand test	Open/grounded circuit, faulty IDM
1668	EF	PCM-IDM diagnostic communication error	Electronic feedback line - KOEO on-demand test	Open/shorted EF or FDCS, open IDM ground
1705	TRS	TR sensor out of self test range	Not in PARK during KOEO or KOER	Operator error, circuit failure, faulty sensor, PCM
1711	TFT	TFT sensor out of self test range	Transmission fluid temp too high for KOEO or KOER test	Transmission too hot or cold, circuit failure, faulty sensor, PCM
1728	TCC	Transmission slip error	Continuous	Solenoid failure or mechanical failure
1729	4x4L	4x4 Low switch error	Continuous	Circuit failure, faulty switch, PCM
1746	EPC	EPC solenoid open circuit	KOEO only	Open circuit, faulty solenoid, PCM
1747	EPC	EPC solenoid short circuit	KOEO only	Short circuit, faulty solenoid, PCM shorted to ground
1748	EPC	EPC malfunction	Continuous	Circuit failure, PCM
1754	CCS	Coast clutch solenoid circuit malfunction	KOEO on-demand test	Circuit failure, faulty solenoid, PCM
1779	TCIL	TCIL circuit malfunction	KOEO on-demand test	Short to ground, PCM
1780	TCS	TCS circuit out of self test range	KOER switch test	Circuit, switch, PCM, failed to activate switch KOER
1781	4X4L	4X4L circuit out of self test range	In 4X4L during KOEO	Operator error, short to ground, PCM
1783	TFT	Transmission overtemperature condition	Continuous	Internal transmission failure, circuit failure, sensor, PCM

(FMEM) MIL illumination occurs after 1st fault
 Transmission Control Indicator Light (TCIL) flashes when fault is present.
 (FMEM) MIL and TCIL illuminate when fault is present

**For Econoline (ALL) and F-250/F-350 (California only)
 refer to Diagnostic Guide #FCS-70230207**

F-Series

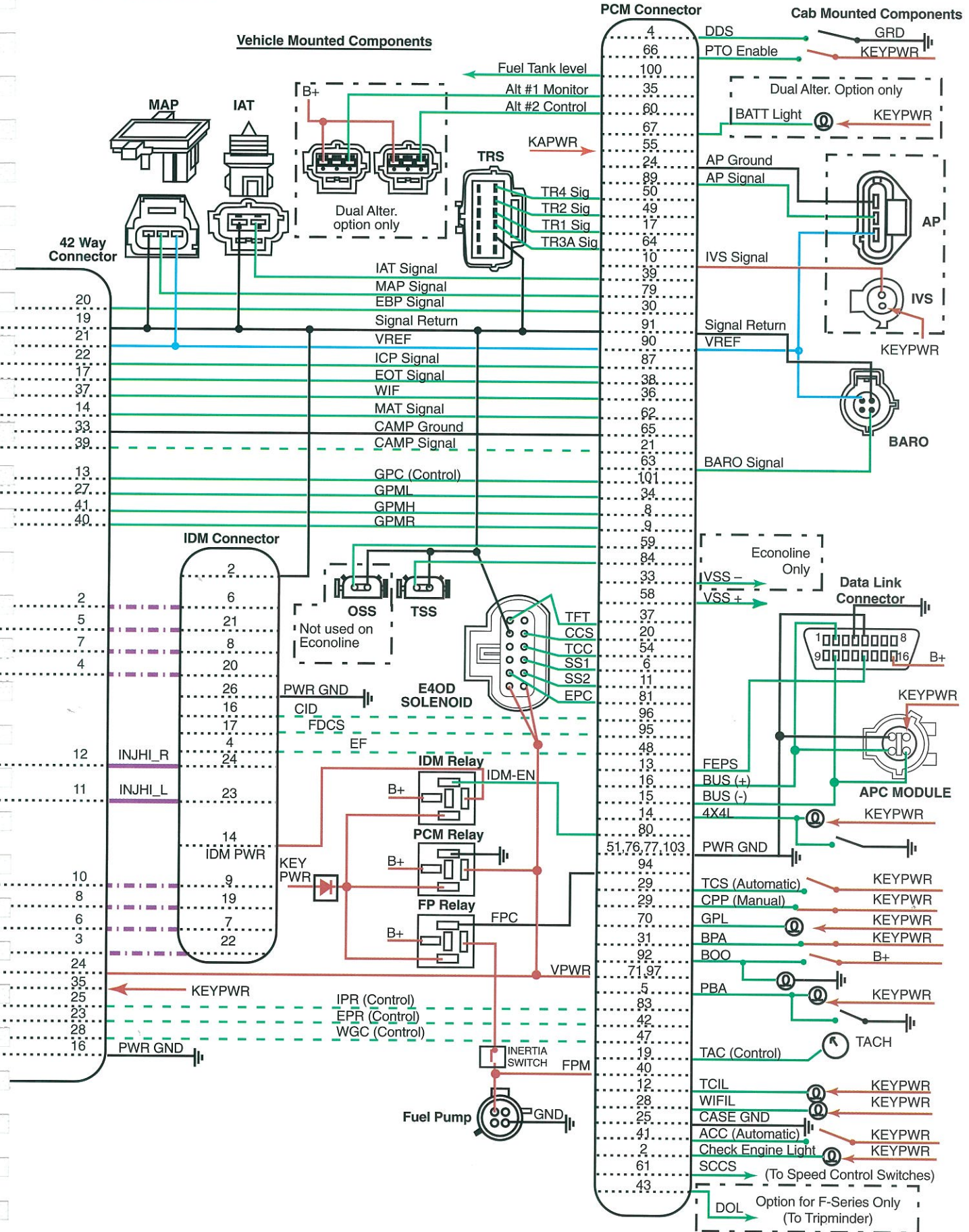

Power Stroke 1999

1998 1/2 E-Series and
1999 F-Series

Fault Code	Circuit Index	Condition Description	Comments	Probable Causes
0107*	BARO	Barometric press sensor circuit low input	Defaults to 100 kPa	Open/grounded circuit, biased sensor, PCM
0108*	BARO	Barometric press sensor circuit high input	Defaults to 100 kPa	Circuit shorted to 5V, biased sensor, PCM
0112*	IAT	Intake air temp sensor circuit low input	Defaults to 15°C	Grounded circuit, biased sensor, PCM
0113*	IAT	Intake air temp sensor circuit high input	Defaults to 15°C	Open circuit, biased sensor, PCM, short to 5V
0122*	AP	Accelerator pedal sensor circuit low input	Engine will only idle if hard fault	Grounded circuit, biased sensor, PCM
0123*	AP	Accelerator pedal sensor circuit high input	Engine will only idle if hard fault	Open circuit, biased sensor, PCM, short to 5V
0197*	EOT	Engine oil temp sensor circuit low input	No cold adv. , fast low idle	Grounded circuit, biased sensor, PCM
0198*	EOT	Engine oil temp sensor circuit high input	No cold adv. , fast low idle	Open circuit, biased sensor, PCM, short to 5V
0220	IVS	Throttle switch B circuit malfunction	Switch test - KOER	Short/open circuit, switch failure, operator, PCM
0221*	AP/IVS	Throttle switch B circuit performance	AP/IVS disagree - Engine will only idle if hard fault	Failed pedal assembly
0230	FP	Fuel Pump relay driver failure	KOEO	
0231*	FP	Fuel Pump relay driver failure pump ON	KOEO	
0232	FP	Fuel Pump relay driver failure pump OFF	KOEO	
0236*	MAP	Turbo boost sensor A circuit performance	Uses Inferred MAP signal	Restricted inlet/exhaust/supply hose
0237*	MAP	Turbo boost sensor A circuit low input	Uses Inferred MAP signal	Open, short to ground or 5V, faulty sensor
0238*	MAP	Turbo boost sensor A circuit high input	Uses Inferred MAP signal	Noise, faulty sensor
0261	INJ	Injector circuit low - Cylinder 1	FMEM mode, engine will run on 4 cyl.	Harness short to ground
0262	INJ	Injector circuit high - Cylinder 1	FMEM mode, engine will run on 4 cyl.	Miswired connector or harness
0263	INJ	Cylinder 1 contribution/balance fault	Cylinder not contributing during CCT test	Power cylinder, valve train or injector problem, circuit
0264	INJ	Injector circuit low - Cylinder 2	FMEM mode, engine will run on 4 cyl.	Harness short to ground
0265	INJ	Injector circuit high - Cylinder 2	FMEM mode, engine will run on 4 cyl.	Miswired connector or harness
0266	INJ	Cylinder 2 contribution/balance fault	Cylinder not contributing during CCT test	Power cylinder, valve train or injector problem, circuit
0267	INJ	Injector circuit low - Cylinder 3	FMEM mode, engine will run on 4 cyl.	Harness short to ground
0268	INJ	Injector circuit high - Cylinder 3	FMEM mode, engine will run on 4 cyl.	Miswired connector or harness
0269	INJ	Cylinder 3 contribution/balance fault	Cylinder not contributing during CCT test	Power cylinder, valve train or injector problem, circuit
0270	INJ	Injector circuit low - Cylinder 4	FMEM mode, engine will run on 4 cyl.	Harness short to ground
0271	INJ	Injector circuit high - Cylinder 4	FMEM mode, engine will run on 4 cyl.	Miswired connector or harness
0272	INJ	Cylinder 4 contribution/balance fault	Cylinder not contributing during CCT test	Power cylinder, valve train or injector problem, circuit
0273	INJ	Injector circuit low - Cylinder 5	FMEM mode, engine will run on 4 cyl.	Harness short to ground
0274	INJ	Injector circuit high - Cylinder 5	FMEM mode, engine will run on 4 cyl.	Miswired connector or harness
0275	INJ	Cylinder 5 contribution/balance fault	Cylinder not contributing during CCT test	Power cylinder, valve train or injector problem, circuit
0276	INJ	Injector circuit low - Cylinder 6	FMEM mode, engine will run on 4 cyl.	Harness short to ground
0277	INJ	Injector circuit high - Cylinder 6	FMEM mode, engine will run on 4 cyl.	Miswired connector or harness
0278	INJ	Cylinder 6 contribution/balance fault	Cylinder not contributing during CCT test	Power cylinder, valve train or injector problem, circuit
0279	INJ	Injector circuit low - Cylinder 7	FMEM mode, engine will run on 4 cyl.	Harness short to ground
0280	INJ	Injector circuit high - Cylinder 7	FMEM mode, engine will run on 4 cyl.	Miswired connector or harness
0281	INJ	Cylinder 7 contribution/balance fault	Cylinder not contributing during CCT test	Power cylinder, valve train or injector problem, circuit
0282	INJ	Injector circuit low - Cylinder 8	FMEM mode, engine will run on 4 cyl.	Harness short to ground
0283	INJ	Injector circuit high - Cylinder 8	FMEM mode, engine will run on 4 cyl.	Miswired connector or harness
0284	INJ	Cylinder 8 contribution/balance fault	Cylinder not contributing during CCT test	Power cylinder, valve train or injector problem, circuit
0301*	INJ	Fault cylinder 1 - Misfire Detected		
0302*	INJ	Fault cylinder 2 - Misfire Detected		
0303*	INJ	Fault cylinder 4 - Misfire Detected		
0304*	INJ	Fault cylinder 5 - Misfire Detected		
0305*	INJ	Fault cylinder 6 - Misfire Detected		
0306*	INJ	Fault cylinder 7 - Misfire Detected		
0307*	INJ	Fault cylinder 3 - Misfire Detected		
0308*	INJ	Fault cylinder 8 - Misfire Detected		
0340	CMP	Camshaft position sensor ckt malfunction	No CMP sensor signal detected during crank	Open/grounded circuit, sensor fault, short to power
0341*	CMP	Camshaft position sensor ckt performance	Electrical noise detected	Harness routing, charging circuit, sensor
0344*	CMP	Camshaft position sensor ckt intermittent	Incorrect number of CMP transition counts	Harness routing, charging ckt, sensor, int ckt, improper gap
0380*	GPC	Glow plug circuit malfunction	Continuous and KOEO on-demand test	Open/grounded ckt, solenoid open/shorted, failed PCMz
0381*	GPL	Glow plug indicator circuit malfunction	Continuous and KOEO on-demand test	Open/grounded circuit, lamp open, failed PCM
0460	FLI	Fuel Level Sensor Circuit Malfunction		
0470	EBP	Exhaust press sensor circuit malfunction	No-start or crank mode	Biased sensor, open signal return
0471*	EBP	Exhaust press sensor circuit performance	Continuous	Plugged, stuck, or leaking hose
0472*	EBP	Exhaust press sensor circuit low input	Disables back pressure device	Open/grounded circuit, biased sensor, PCM
0473*	EBP	Exhaust press sensor circuit high input	Disables back pressure device	Circuit shorted to 5V, biased sensor, PCM
0475*	EPR	Exhaust press control valve malfunction	Continuous & KOEO on-demand test	Open/grounded ckt, solenoid open/shorted, failed PCM
0476	EPR	Exhaust press control valve performance	KOER on-demand test	Failed/stuck EPR, EBP fault, EPR circuit
0478*	EPR	Exhaust press control valve high input	Excessive back pressure - Continuous	Plugged sensor line, stuck butterfly, restricted exhaust
0500*	VSS	Vehicle speed sensor malfunction	Continuous	Sensor, circuit, PCM, PSOM, low trans fluid
0560	N/A	System voltage malfunction	B+ too low for KOER on-demand or CCT test - aborts test	Charging system problem/load, glow plugs still enabled
0562*	VPWR	System voltage low	May be temporary condition at crank only	Low sys voltage, charging sys, internal PCM failure
0563	VPWR	System voltage high	May be temporary condition - 24V jump start	High sys voltage, charging sys, internal PCM failure
0565	SCCS	Cruise On signal malfunction	KOER switch test (Code set if cruise not present)	Open or short circuit, switch failure, PCM failure or failed to activate switch during KOER switch test
0566	SCCS	Cruise Off signal malfunction	KOER switch test (Code set if cruise not present)	
0567	SCCS	Cruise Resume signal malfunction	KOER switch test (Code set if cruise not present)	
0568	SCCS	Cruise Set signal malfunction	KOER switch test (Code set if cruise not present)	
0569	SCCS	Cruise Coast signal malfunction	KOER switch test (Code set if cruise not present)	
0571	BPA	Brake switch A circuit malfunction		
0603	PCM	Powertrain Control Module KAM test error		
0605	PCM	Powertrain Control Module ROM test error		
0606	PCM	PCM processor fault		
0703	BOO	Brake switch B circuit malfunction		
0704	CPP	Clutch switch input circuit malfunction		
0705*	TRS	Trans range sensor circuit malfunction		
0707	TRS	Trans range sensor circuit low input		
0708*	TRS	Trans range sensor circuit high input		
0712	TFT	Trans fluid temp sensor ckt low input	KOEO, KOER, and Continuous	Open analog TRS, open pin 64 digital TRS
0713	TFT	Trans fluid temp sensor ckt high input	KOEO, KOER, and Continuous	Short to ground, biased sensor, PCM
0715*		TSS sensor circuit malfunction fault		Open circuit, biased sensor, PCM, short to power
0720*		OSS sensor circuit malfunction fault		
0731		Gear #1 Ratio Error	Continuous	
732		Gear #2 Ratio Error	Continuous	
0733		Gear #3 Ratio Error	Continuous	
0741	TCC	Torque converter clutch ckt performance	Continuous	
0743*	TCC	Torque converter clutch system electrical	KOEO and Continuous	Faulty solenoid, PCM
0750*	SS1	Shift solenoid A malfunction	KOEO and Continuous	Circuit failure, faulty solenoid, PCM
0751		CCM SSA Shift solenoid #1 fault		
0755*	SS2	Shift solenoid B malfunction	Continuous and KOEO	
0756		CCM SSB Shift solenoid #2 fault		
0760		CCM SSC Shift solenoid #3 fault		
0781	N/A	1-2 shift error	Continuous	

POWERTRAIN CONTROL SYSTEM ELECTRONICS DIAGNOSTIC GUIDE

Fault Code	Circuit Index	Condition Description	Comments	Probable Causes
0782	N/A	2-3 shift error	Continuous	
0783	N/A	3-4 shift error	Continuous	
1000	N/A	Check of all OBDII systems not complete		
1105	ALT	Dual Alternator upper fault		
1106	ALT	Dual alternator lower fault		
1107*	ALT	Dual alternator lower circuit malfunction		
1108	ALT	Dual alternator battery lamp circuit malfunction		
1118*	MAT	Manifold Air Temp sensor out of range low	KOEO	
1119*	MAT	Manifold Air Temp sensor out of range high	KOEO	
1139	WIF	Water-in-Fuel circuit malfunction	KOEO	
1140	WIF	Water-in-Fuel condition failure		
1184	EOT	Engine oil temp sensor out of self test range	Engine not warm enough to run KOER CCT - aborts test	Engine not warm enough, leaking thermostat, ckt failure
1209*	IPR	Injection control pressure system fault		IPR valve stuck
1210*	IPR	Injection control pressure above expected level	No-start mode and KOEO on-demand test	
1211*	IPR	ICP pressure above/below desired	Continuous and KOER on-demand test	IPR valve failed, stuck, or shorted to ground
1212	ICP	ICP press not detected during crank	Crank only	Biased sensor or ckt, open signal return, low oil in reservoir
1218	CI	CI stuck high	Cylinder identification line stuck high	CI circuit open, probably intermittent
1219	CI	CI stuck low	Cylinder identification line stuck low	CI circuit short to ground, probably intermittent
1247*	MAP	Turbo boost pressure low		
1248*	MAP	Turbo boost pressure not detected		
1249*	WG	Waste-gate failure steady state		Hose disconnected
1261-1268	INJ	High to low side short cyl#1 - #8	Cylinder with fault will not operate	
1271-1278	INJ	High to low side open cyl#1 - #8	Cylinder with fault will not operate	Short circuit, shorted injector, failed IDM
1280*	ICP	ICP circuit out of range low	Uses inferred ICP strategy	Open circuit, open injector, failed IDM
1281*	ICP	ICP circuit out of range high	Uses inferred ICP strategy	Open/grounded circuit, biased sensor, PCM
1282*	IPR	Excessive ICP pressure	System fault	Circuit shorted to 5V, biased sensor, PCM
1283	IPR	IPR circuit failure	Continuous & KOEO on-demand test	Faulty IPR regulator (sticking), IPR shorted to ground
1284	N/A	ICP failure - aborts KOER test	Aborts KOER CCT and on-demand tests	Open/grounded circuit, stuck IPR, loose connection
1291	INJ	High side short to grd or B+, bank #1 (right)	Inj power supply circuit short (operates on 4 cylinders)	Sensor circuit fault
1292	INJ	High side short to grd or B+, bank #2 (left)	Inj power supply circuit short (operates on 4 cylinders)	See codes 1280, 1281, 1282, 1283, 1211
1293	INJ	High side open bank #1 (right)	Inj power supply circuit open (operates on 4 cylinders)	Shorted circuit, faulty IDM
1294	INJ	High side open bank #2 (left)	Inj power supply circuit open (operates on 4 cylinders)	Shorted circuit, faulty IDM
1295	INJ	Multiple faults on bank #1 (right) with low side short		Open circuit, faulty IDM
1296	INJ	Multiple faults on bank #2 (left) with low side short		Open circuit, faulty IDM
1297	INJ	High sides shorted together	Fix shorts and rerun diagnostics	Fix low side short and rerun diagnostics
1298	IDM	IDM failure	Internal IDM failure	Miswired connector or harness, short to ground
1316*	IDM	Injector circuit/IDM codes detected	Run KOEO on-demand test to retrieve codes	Fix low side short and rerun diagnostics
1389	GPM	Glow Plug High Side out of range low	KOEO	Miswired connector or harness, short to ground
1391*	GPM	Glow plug circuit low input, bank #1 (right)	Aborts glow plug monitoring	Shorted wires, faulty IDM
1393*	GPM	Glow plug circuit low input, bank #2 (left)	Aborts glow plug monitoring	Internal IDM failure
1395*	GPM	Glow plug monitor fault, bank #1	Continuous & KOEO glow plug monitor test	Injector circuit/IDM codes detected
1396*	GPM	Glow plug monitor fault, bank #2	Continuous & KOEO glow plug monitor test	Open circuit, short to power or ground, faulty relay
1397	VPWR	System voltage out of self test range	Aborts KOEO glow plug monitor test	Open circuit, short to power or ground, faulty relay
1399	GPM	Glow Plug High Side out of range high		One or more glow plugs failed
1464	N/A	A/C demand out of self test range	Aborts KOER CCT test	One or more glow plugs failed
1501	N/A	VSS out of self test range	Aborts test - KOER on-demand, CCT, or switch test	System voltage too high or low for glow plug monitor test
1502	N/A	Invalid test - APCM functioning	Aborts test - KOER on-demand, CCT, or switch test	
1531	N/A	Invalid test - accelerator pedal movement	Aborts test - KOER on-demand or CCT test	
1536	PBA	Parking brake switch circuit failure	KOER switch test	Operator error
1634	DOL	Data Output Link failure		Failed to activate switch during test, circuit, switch, PCM
1660	OCC	OCC signal high	Aborts KOEO on-demand test	
1661	OCC	OCC signal low	Aborts KOEO on-demand test	
1662	IDM EN	IDM EN circuit failure	Continuous & KOEO on-demand test	High system voltage, internal PCM fault
1663	FDSC	FDSC circuit failure	Fuel demand command signal - KOEO on-demand test	Low system voltage, internal PCM fault
1667	CI	CI circuit failure	Cylinder identification circuit - KOEO on-demand test	Open IDM relay, blown fuse, open/grounded circuit
1668	EF	PCM-IDM diagnostic communication error	Electronic feedback line - KOEO on-demand test	Open/grounded circuit, faulty IDM
1670*	EF	EF signal not detected	Continuous	Open/shorted EF or FDSC, open IDM ground
1690*	WG	Waste-gate failure KOEO	KOEO	Open/shorted EF circuit
1700		OSS sensor intermittent circuit malfunction		
1701		TSS sensor intermittent circuit malfunction		
1702		TRS sensor intermittent circuit malfunction		
1704	TRS	Digital TRS failed to transition state	KOEO only	
1705	TRS	TR sensor out of self test range	Not in PARK during KOEO or KOER	Sensor, wiring, PCM, mechanical alignment
1706		E4OD fails - Vehicle speed excessive in park		Operator error, circuit failure, faulty sensor, PCM
1711	TFT	TFT sensor out of self test range	Transmission fluid temp too high or low for KOEO or KOER test	
1713		TOT stuck high in-range failure below 50°F		Transmission too hot or cold, circuit failure, faulty sensor, PCM
1714*	SS1	Shift Solenoid 1 inductive signature malfunction	Continuous	
1715*	SS2	Shift Solenoid 2 inductive signature malfunction	Continuous	Solenoid or PCM
1716		TOT stuck high in-range failure between 50-250°F		Solenoid or PCM
1718		TOT stuck high in-range failure above 250 °F		
1727		CCS inductive signature malfunction		
1728	TCC	Transmission slip error	Continuous	Solenoid failure or mechanical failure
1729	4x4L	4x4 Low switch error	Continuous	Circuit failure, faulty switch, PCM
1740	TCC	Torque converter clutch inductive sig malfunction	Continuous	Solenoid or PCM
1741				
1742	TCC	TCC mechanical failure		Solenoid stuck on
1744*		Excessive slip across convertor clutch		
1746	EPC	EPC solenoid open circuit	Continuous	Open circuit, faulty solenoid, PCM
1747*	EPC	EPC solenoid short circuit	Continuous	Short circuit, faulty solenoid, PCM shorted to ground
1748	EPC	EPC malfunction	Continuous	Circuit failure, PCM
1751		SSB shift solenoid #1 fault		
1754	CCS	Coast clutch solenoid circuit malfunction	Continuous & KOEO on-demand test	Circuit failure, faulty solenoid, PCM
1756		SSB shift solenoid #2 fault		
1779		TCIL Failure		
1780	TCS	TCS circuit out of self test range	KOER switch test	
1781	4X4L	4X4L circuit out of self test range	In 4X4L during KOEO	Circuit, switch, PCM, failed to activate switch or switch always active during KOER
1783	TFT	Transmission overtemperature condition	Continuous	Operator error, short to ground, PCM
				Internal transmission failure, circuit failure, sensor, PCM

* (OBDII) MIL illumination occurs after 2nd consecutive fault
(FMEM) MIL illumination occurs after 1st fault
Transmission Control Indicator Light (TCIL) flashes when fault is present.
TCIL illuminates on 49 state applications only

1998 1/2 Econoline

Hard Start / No Start Diagnostics

NOTE: A hard start/ No start concern with EOT Temp. below 60F perform step 10 first.

1. Visual Engine/Chassis Inspection

Fuel Oil Coolant Electrical Hoses Leaks	
Method	Check
Visual	

2. Check Engine Oil Level

See Fig. C

- Check for contaminants (fuel, coolant)
- Correct Grade/Viscosity
- Miles/Hours on oil ,correct level
- Check level in reservoir

Method	Check
Visual	

3. Intake/Exhaust Restriction

See Fig. B & L

- Inspect air filter and ducts - exhaust system
- Inspect exhaust back pressure device

Method	Check
Visual	

4. Sufficient Clean Fuel

See Fig. A

- Check if the WATER IN FUEL lamp has been illuminated.
- After verifying that there is fuel in the tank, drain a sample from fuel filter housing by key on, engine off.

NOTE: Fuel pump will only run for 20 sec.

Method	Checks
Visual	

5. Electric Fuel Pump Pressure

See Fig. I

- After verifying that there is fuel in the tank and the pump is being powered, Measure at the top of the left cylinder head with a (0-160 PSI) gauge.
- Key on, engine off. - Pump will run for about 20 sec.

Instrument	Spec.	Measurement
0-160 PSI Gauge	30 PSI min.	

If pressure fails low, Go to step 8c on the Performance side of this sheet, to pinpoint the cause.

6. Perform KOEO On Demand Test

See Fig. E

- Use the NGS Tester
- DTCs set during this test are current faults.

Note: IDM DTCs displayed here could be current or historical faults.

Diagnostic Trouble Codes

7. Retrieve Continuous Trouble Codes

See Fig. E

- DTCs retrieved during this test are historical faults.

Note: IDM historical DTCs can be clear here

even if none are displayed.

Diagnostic Trouble Codes

8. KOEO Injector Electrical Self-Test

See Fig. E

- Use the NGS Tester.
- All injectors will momentarily buzz, then individual injectors will buzz in sequence 1 through 8.
- IDM DTCs may be transmitted after test is completed.

Note: IDM DTCs can be historical if not cleared above.

Injector Trouble Codes

9. NGS Tool - Data List Monitoring

See Fig. E

- NGS Tester may reset below 9.5 volts.
- Select the parameters indicated from the NGS parameter list and monitor while cranking engine.

Parameter	Spec.	Measurement
V PWR	7 volt min.	
You may need to use a outside power source for the NGS		
RPM	100 RPM minimum	
ICP	500 PSI or 3.4 mPa min.	
FUEL PW	1 mS to 6 mS	

- A - V PWR - If indicating a low voltage condition, check battery voltage, charging system or power and ground circuits to the PCM.

GO TO PINPOINT TEST A

- B - RPM - Low RPM could be an indication of starting/ charging system problems, No RPM indicated with the engine cranking - could be CMP circuit fault, check for Diagnostic Trouble Codes.

GO TO PINPOINT TEST DG

- C - ICP - A minimum of 500 PSI (3.4 mPa) is required before the injectors are enabled. No or low oil in the reservoir, system leakage, injector O-Rings or faulty IPR could cause pressure loss.

Go to section 4B step 9c in the PC/ED Manual for a detailed description on how to perform this test.

Note: If a no RPM signal is received, IPR duty-cycle will default to 14%

See Fig. E & F

- D - FUEL PW - Even though a 1 to 6 mS FUEL PW is shown on the NGS to be sent to the IDM, it's possible that the IDM did not get the signal, due to a fault on ether CID or FDCCS circuits or even the IDM.

10. Glow Plug System Operation

See Fig. E & G

Relay Operation

- Glow Plug ON time is dependent on oil temperature and altitude. The Glow Plug relay comes on between 1 to 120 sec. and does not come on at all if oil Temp is above 86 F
- Verify that B+ is being supplied on the large BK/W wire going to the Glow Plug relay.
- Install a voltmeter to the glow plug feed terminal (terminal with two brown wires) or (center terminal on the shunt for California).
- Turn key to run position, measure "ON" time
- Using the NGS GPCTM and EOT pids, verify sufficient glow plug "ON" time and voltage.

(Dependent on oil temperature and altitude)

9 - 12 volts Relay On time	Spec. 1 to 120 seconds	Measurement

Note: Wait to Start Lamp "On" time (1 - 10 sec.)

Is Independent from Glow Plug Relay "On" time

Glow Plug Operation

- Measure Glow Plug Resistance to Bat. Ground.
- Remove both 9 pin connectors from valve covers
- Measure GP Harness Resistance to Relay

Glow Plug Number	Glow Plug to Ground .1 to 2 ohms	Connector to Relay 0 to 1 ohms
# 1		
# 3		
# 5		
# 7		
# 2		
# 4		
# 6		
# 8		

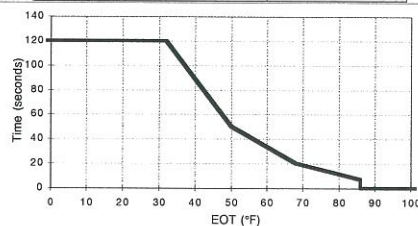

- Add 5 seconds to glow plug on time when above 7000 feet in altitude, but not to exceed 120 seconds.

See PC/ED manual, Section 4B for more detail on all of the above test steps.

1998 1/2 Econoline

Performance Diagnostics

1. Visual Engine/Chassis Inspection

- Verify that there are no fluid or pressure leaks.
- Inspect all wire connection for damage
- Inspect MAP hose and Intake for leaks.

Method	Check
Visual	

2. Sufficient Clean Fuel

See Fig. A

- Check if WATER IN FUEL lamp has been illuminated.
- Drain sample from fuel filter housing by key on, engine off.

NOTE: Pump will only run for 20 sec.

Method	Check
Visual	

3. Check Engine Oil Level

See Fig. C

- Check for contaminants (fuel, coolant).
- Correct Grade/Viscosity.
- Miles/hours on oil, correct level.

Method	Check
Visual	

4. Intake Restriction

See Fig. B

- Check filter minder
- Measure at WOT w/magnehelic gauge.

Instrument	Spec.	Check
Magnehelic/ Filter Minder	2" - 25" H \emptyset	

5. Perform KOEO On Demand Test

See Fig. E

- Use the NGS Tester.
- DTCs set during this test are current faults.

Note: IDM DTCs displayed here could be current or historical faults.

Diagnostic Trouble Codes

6. Retrieve Continuous Trouble Codes

See Fig. E

- Use the NGS Tester.
- DTCs retrieved during this test are historical faults.

Note: IDM historical DTCs can be clear here even if none are displayed.

Diagnostic Trouble Codes

7. KOEO Injector Electrical Self-Test

See Fig. E

- Use the NGS Tester.
- All injectors will momentarily buzz, then individual injectors will buzz in sequence 1 through 8.

Note: IDM DTCs can be historical if not cleared above.

Injector Trouble Codes

8a. Fuel Pressure at the left head

See Fig. I

- Verify that fuel is in the tank and the pump is being powered.
- Measure fuel pressure at the rear of left head

CAUTION: Secure test hose away from turbo and exhaust.

- Road Test - with a full load on the engine.

Instrument	Spec.	Measurement
0-160 PSI Gauge	30 PSI min.	

- If fuel pressure falls low, Go to step 8c.
- If pressure is above min. spec, Go to step 8b.

8b. Fuel Pressure at the right head

See Fig. I

- Measure fuel pressure at the front of right head
- Test under full load, but don't brake torque engine any longer than 10 sec.

Instrument	Spec.	Measurement
0-160 PSI Gauge	30 PSI min.	

- If fuel pressure is below min. spec, replace right check valve
- If fuel pressure is above min. spec, Go to step 9.

8c. Electric Fuel Pump Pressure

See Fig. I

- Measure at fuel outlet from Electric fuel pump.
- Road Test - with a full load on the engine.

Instrument	Spec.	Measurement
0-160 PSI Gauge	30 - 80 PSI	

- If fuel pressure falls low, Go to step 8d.
- If pressure is above min. spec, replace left check valve.

8d. Electric Fuel Pump Inlet Restriction

See Fig. H

- Measure WOT at fuel inlet to Electric fuel pump for restriction

Instrument	Spec.	Measurement
0-30 " Hg vacuum G	6" Hg MAX	

- If fuel line is restricted above 6" Hg, check for Blockage between pump and fuel tank.
- If fuel line is not restricted, inspect regulator valve condition and for debris, if OK replace pump

9. Perform KOER On Demand Test

See Fig. F

KOER DTCs

10a. Injection Control Pressure Tests

See Fig. D & E

- (Oil Aeration - Poor Idle quality)
- All acc. off, Monitor ICP and RPM with NGS Tester
- Hold engine speed at 3400 RPM for 3 minutes.

Parameter	High RPM	Measurement
ICP	1250 PSI MAX @ 3400 RPM	

- If ICP signal increases above 1250 PSI after 3 minutes anti-foam oil additives may have become depleted from oil, change oil and re-test.

10b. Low Idle Stability (ICP Pressure)

See Fig. E

- Check at low idle
- Monitor ICP and RPM with the NGS Tester

Low Idle

Parameter	Spec. @ 650 RPM	Measurement
ICP	400 to 600 PSI	

Take reading before disconnecting ICP

If engine RPM is unstable disconnect the ICP sensor

NOTE: ICP will default to 725 PSI when disconnected.

» If RPM is still unstable, change the IPR and re-test.

» If RPM smooths out, the ICP signal is at fault.

11. Crankcase Pressure Test

See Fig. J

- Assure engine is at normal operating temp.
- Measure at oil fill with adapter and orifice tool P.N. 5631 & 014-00743 installed.
- Block breather tube on left valve cover.
- Measure at WOT under no load.

Instrument	Spec.	Measurement
Magnehelic	less than 4" H \emptyset	

If more than 4" H \emptyset , Refer base engine in Shop Manual

12. Cylinder Contribution Test

See Fig. E

- Ensure that EOT is above 70 F min.
- Turn A/C and all accessories off
- Select Cylinder Contribution from the test menu

NOTE: The newly designed test will run at a idle for about

110 sec. and you will not feel any change through-out the test.

CCT Trouble Codes

13. Exhaust Restriction

See Fig. E, K & L

- Visually inspect exhaust system for damage
- Verify EBP device is open at WOT in park or neutral
- Monitor EBP with the NGS Tester with the engine temperature at 170 ° F minimum at 3400 RPM.

Parameter	Spec.	Measurement
EBP	34 PSI MAX @ 3400 RPM	

14. Boost Pressure Test

See Fig. E &

- Verify that MAP hose is not open, plugged or pinched
- Monitor MGP (manifold gauge pressure) and RPM with the NGS Tester.
- Road Test - select appropriate gear to obtain desired engine speed at full load throttle position. Best accomplished climbing hill or truck fully loaded.

Parameter	Spec. PSI G	Measurement
MGP	13 PSI G MIN	

Measure between 2500 to 3000 RPM

See PC/ED manual, Section 4B for more detail on all of the above test steps.

1999 F-Series

Hard Start / No Start Diagnostics

NOTE: A hard start/ No start concern with EOT Temp. below 60F perform step 10 first.

1. Visual Engine/Chassis Inspection

Fuel Oil Coolant Electrical Hoses Leaks	
Method	Check
Visual	

2. Check Engine Oil Level

See Fig. C

- Check for contaminants (fuel, coolant).
- Correct Grade/Viscosity.
- Miles/Hours on oil ,correct level.
- Check level in reservoir.

Method	Check
Visual	

3. Intake/Exhaust Restriction

See Fig. B & L

- Inspect air filter and ducts - exhaust system
- Inspect exhaust back pressure device

Method	Check
Visual	

4. Sufficient Clean Fuel

See Fig. A

- Check if the WATER IN FUEL lamp has been illuminated.
- After verifying that there is fuel in the tank, drain a sample from fuel filter housing by key on, engine off.

NOTE: Fuel pump will only run for 20 sec.

Method	Check
Visual	

5. Electric Fuel Pump Pressure

See Fig. I

- After verifying that there is fuel in the tank and the pump is being powered, Measure at the top of the right cylinder head with a (0-160 PSI) gauge.
- Key on, engine off. - Pump will run for about 20 sec.

Instrument	Spec.	Measurement
0-160 PSI Gauge	30 PSI min.	

If pressure fails low, Go to step 8c on the Performance side of this sheet, to pinpoint the cause.

6. Perform KOEO On Demand Test

See Fig. E

- Use the NGS Tester
- DTCs set during this test are current faults.

Note: IDM DTCs displayed here could be current or historical faults.

Diagnostic Trouble Codes

7. Retrieve Continuous Trouble Codes

See Fig. E

- DTCs retrieved during this test are historical faults.

Note: IDM historical DTCs can be cleared here even if none are displayed.

Diagnostic Trouble Codes

8. KOEO Injector Electrical Self-Test

See Fig. E

- Use the NGS Tester.
- All injectors will momentarily buzz, then individual injectors will buzz in sequence 1 through 8.
- IDM DTCs may be transmitted after test is completed.

Note: IDM DTCs can be historical if not cleared above.

Injector Trouble Codes

9. NGS Tool - Data List Monitoring

See Fig. E

- NGS Tester may reset below 9.5 volts.
- Select the parameters indicated from the NGS parameter list and monitor while cranking engine.

Parameter	Spec.	Measurement
V PWR	7 volt min.	
You may need to use a outside power source for the NGS		
RPM	100 RPM minimum	
ICP	500 PSI or 3.4 mPa min.	
FUEL PW	1 mS to 6 mS	

- A - V PWR - If indicating a low voltage condition, check battery voltage, charging system or power and ground circuits to the PCM.

GO TO PINPOINT TEST A

- B - RPM - Low RPM could be an indication of starting/ charging system problems, No RPM indicated with the engine cranking - could be CMP circuit fault, check for Diagnostic Trouble Codes.

GO TO PINPOINT TEST DG

- C - ICP - A minimum of 500 PSI (3.4 mPa) is required before the injectors are enabled. No or low oil in the reservoir, system leakage, injector O-Rings or faulty IPR could cause pressure loss.

Go to section 4B step 9c in the PC/ED Manual for a detailed description on how to perform this test.

Note: If a no RPM signal is received, IPR duty-cycle will default to 14%

See Fig. E & F

- D - FUEL PW - Even though a 1 to 6 mS FUEL PW is shown on the NGS to be sent to the IDM, it's possible that the IDM did not get the signal, due to a fault on either CID or FDOS circuits or even the IDM.

10. Glow Plug System Operation

See Fig. E & G

Relay Operation

- Glow Plug ON time is dependent on oil temperature and altitude. The Glow Plug relay comes on between 1 to 120 sec. and does not come on at all if oil Temp is above 131 F
- Verify that B+ is being supplied on the large BK/W wire going to the Glow Plug relay.
- Install a voltmeter to the glow plug feed terminal (terminal with two brown wires) or (center terminal on the shunt for California).
- Turn key to run position, measure "ON" time
- Using the NGS GPCTM and EOT pids, verify sufficient glow plug "ON" time and voltage.

(Dependent on oil temperature and altitude)

θ - 12 volts	Spec.	Measurement
Relay On time	1 to 120 seconds	

Note: Wait to Start Lamp "On" time (1 - 10 sec.)

is independent from Glow Plug Relay "On" time

Glow Plug Operation

- Measure Glow Plug Resistance to Bat. Ground.
- Remove both 9 pin connectors from valve covers
- Measure GP Harness Resistance to Relay

Glow Plug Number	Glow Plug to Ground	Connector to Relay
# 1	.1 to 2 ohms	0 to 1 ohms
# 3		
# 5		
# 7		
# 2		
# 4		
# 6		
# 8		

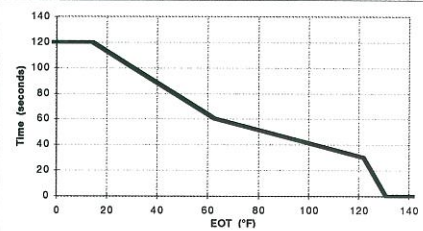

- Add 5 seconds to glow plug on time when above 7000 feet in altitude, but not to exceed 120 seconds.

See PC/ED manual, Section 4B for more detail on all of the above test steps.

1999 F-Series

Performance Diagnostics

1. Visual Engine/Chassis Inspection

- Verify that there are no fluid, vacuum or pressure leaks.
- Inspect all wire connection for damage.
- Inspect MAP, WGC hoses and Intake for leaks.

Method	Check
Visual	

2. Sufficient Clean Fuel

- Check if WATER IN FUEL lamp has been illuminated.
- Drain sample from fuel filter housing by key on, engine off.

NOTE: Pump will only run for 20 sec.

Method	Check
Visual	

3. Check Engine Oil Level

- Check for contaminants (fuel, coolant).
- Correct Grade/Viscosity.
- Miles/hours on oil, correct level.

Method	Check
Visual	

4. Intake Restriction

- Check filter minder
- or Measure at WOT w/magnehelic gauge.

Instrument	Spec.	Check
Magnehelic Filter Minder	2" - 2.5" H 0 0	

5. Perform KOEO On Demand Test

- Use the NGS Tester.
- DTCs set during this test are current faults.

Note: IDM DTCs displayed here could be current or historical faults.

Diagnostic Trouble Codes

6. Retrieve Continuous Trouble Codes

- Use the NGS Tester.
- DTCs retrieved during this test are historical faults.

Note: IDM historical DTCs can be clear here even if none are displayed.

Diagnostic Trouble Codes

7. KOEO Injector Electrical Self-Test

- Use the NGS Tester.
- All injectors will momentarily buzz, then individual injectors will buzz in sequence 1 through 8.

Note: IDM DTCs can be historical if not cleared above.

Injector Trouble Codes

8a. Fuel Pressure at the right head

- Verify that fuel is in the tank and the pump is being powered.
- Measure fuel pressure at the Front of right head
- Road Test- with a full load on the engine.

Instrument	Spec.	Measurement
0-160 PSI Gauge	30 PSI min.	

* If fuel pressure fails low, Go to step 8c.

* If pressure is above min. spec, Go to step 8b.

8b. Fuel Pressure at the left head

- Measure fuel pressure at the rear of left head

CAUTION: Secure test hose away from turbo and exhaust.

- Road Test- with a full load on the engine.

Instrument	Spec.	Measurement
0-160 PSI Gauge	30 PSI min.	

* If fuel pressure is below min. spec, replace left check valve

* If fuel pressure is above min. spec, Go to step 9.

8c. Electric Fuel Pump Pressure

- Measure at fuel outlet from Electric fuel pump.
- Road Test- with a full load on the engine.

Instrument	Spec.	Measurement
0-160 PSI Gauge	3 0 - 8 0 PSI	

* If fuel pressure fails low, Go to step 8d.

* If pressure is above min. spec, replace right check valve.

8d. Electric Fuel Pump Inlet Restriction

- Measure WOT at fuel inlet to Electric fuel pump for restriction

Instrument	Spec.	Measurement
0-30 " Hg vacuum G	6" Hg MAX	

* If fuel line is restricted above 6" Hg, check for Blockage between pump and fuel tank.

* If fuel line is not restricted, inspect regulator valve condition and for debris, if OK replace pump

9. Perform KOER On Demand Test

- This will test both ICP and EBP systems for fault.

KOER DTC

10a. Injection Control Pressure Tests

- (Oil Aeration - Poor idle quality)
- All acc. off, Monitor ICP and RPM with NGS Tester
- Hold engine speed at 3400 RPM for 3 minutes.

Parameter	High RPM	Measurement
ICP	1250 PSI MAX @ 3400 RPM	

If ICP signal increases above 1250 PSI after 3 minutes anti-foam oil additives may have become depleted from oil, change oil and re-test.

10b. Low Idle Stability (ICP Pressure)

- Check at low idle
- Monitor ICP and RPM with the NGS Tester

Parameter	Spec. @ 650 RPM	Measurement
ICP	400 to 600 PSI	

Take reading before disconnecting ICP

If engine RPM is unstable disconnect the ICP sensor

NOTE: ICP will default to 725 PSI when disconnected.

* If RPM is still unstable, change the IPR and re-test.

* If RPM smoothes out, the ICP signal is at fault.

11. Crankcase Pressure Test

- Assure engine is at normal operating temp.
- Measure at oil fill with adapter and orifice tool P.N. 5631 & 014-00743 installed.
- Block breather tube on left valve cover.
- Measure at WOT under no load.

Instrument	Spec.	Measurement
Magnehelic	less than 0 to 60" H ₀ 0	

If more than 4" H₀0, Refer base engine in Shop Manual

12. Cylinder Contribution Test

- Ensure that EOT is above 70 F min.
- Turn A/C and all accessories off.
- Select Cylinder Contribution from the test menu.

NOTE: The newly designed test will run at a idle for about

110 sec. and you will not feel any change through-out the test.

CCT Trouble Codes

13. Exhaust Restriction

- Visually inspect exhaust system for damage
- Verify EBP device is open at WOT in park or neutral
- Monitor EBP with the NGS Tester with the engine temperature at 170 ° F minimum at 3400 RPM.

Parameter	Spec.	Measurement
EBP	34 PSI MAX @ 3400 RPM	

14. Boost Pressure Test

- Verify that MAP hose is not open, plugged or pinched
- Verify that inter cooler hoses or intake are not leaking.
- Verify that the green Waste gate hose is not plugged.
- Monitor MGP (manifold gauge pressure) and RPM with the NGS Tester.

- Road Test - select appropriate gear to obtain desired engine speed at full load throttle position.

Best accomplished climbing hill or truck fully loaded.

Parameter	Spec. PSI G	Measurement
MGP	16 PSI G MIN	

Measure between 2500 to 3000 RPM

See PC/ED manual, Section 4B for more detail on all of the above test steps.

APS Accelerator Position Sensor

A potentiometer style sensor that indicates the operator's pedal position.

Actuator

A device which delivers motion in response to an electrical signal.

Analog

A continuously variable voltage.

BARO Barometric Pressure Sensor

An analog device which indicates atmospheric pressure which allows the PCM to compensate for altitude. A BARO sensor has three connections, signal return (gnd), BARO signal, and Vref.

CAC Charge Air Cooling

A process of cooling the air coming out of the turbo before it enters the engine.

CMP Camshaft Position Sensor

A Hall effect sensor used to indicate engine speed and camshaft position. Speed is indicated by the number of vanes counted per revolution. Camshaft position is indicated by a single narrow vane which indicates #1 cylinder position or a wide vane in dual sync application that indicates #6 cylinder.

DVOM Digital Volt Ohm Meter

A meter that uses a digital display to indicate a measured value. Preferred for use on microprocessor systems because a DVOM has a very high internal impedance and will not load down the circuit being measured.

EBP Exhaust Back Pressure Regulator

A pulse width modulated controlled butterfly valve mounted on the exhaust side of the turbocharger used to create exhaust back pressure to insure faster engine and cab warmup.

EBP Exhaust Back Pressure Sensor

A transducer style sensor used to indicate exhaust back pressure.

EOT Engine Oil Temperature

A thermistor type sensor which indicates engine temperature.

GPR Glow Plug Relay

Relay which supplies power to the glow plugs.

Hall Effect Sensor

A Hall Effect sensor generates a digital on/off signal that indicates speed and also engine timing. The signal is created by a switching action caused by the passing of a vane thru a positive and negative voltage potential. When the vane is between this potential, a signal is created. When the gap in between this potential is open, no signal is generated. The wider the vane the longer the duty cycle of the signal, the narrower the vane the shorter the duty cycle of the signal. A narrow vane is used to indicate the position of #1 cylinder and a wide vane to indicate the position of #8. A Hall Effect sensor has three connections: ground, Vref, and signal.

IAT Intake Air Temperature Sensor

A thermistor style sensor used to indicate air temperature.

ICP Injector Control Pressure

A transducer style sensor used to indicate gallery pressure.

IPR Injection Control Regulator

Controls injection oil pressure. An electrical signal to a solenoid creates a magnetic field which applies a variable force on a poppet to control pressure. The quantity of fuel delivered to the combustion chamber is proportional to injection control pressure.

IDM Injector Drive Module

An electronic unit which has the primary function of an electronic distributor for the injectors. It also is the power supply for the injectors. It supplies 90v @ 7 amps to the injectors.

IVS Idle Validation Switch

An on/off switch sensor that indicates when the accelerator pedal is in the idle position.

Impedance

A form of opposition to AC current flow measured in Ohms.

KOEO Key On Engine Off Test

A self-test operation that is performed with the ignition switch in the ON position with the engine off.

KOER Key On Engine Running Test

A self-test operation that is performed with the ignition switch in the ON position and the engine running.

GLOSSARY

MAP Manifold Absolute Pressure

A MAP sensor is a sensor that generates a digital frequency that indicates manifold boost pressure or vacuum. The signal is created by switching action caused by manifold pressure on a diaphragm connected to a capacitor circuit in the sensor. The digital frequency increases as pressure increases. A MAP sensor has three connections: signal return (gnd), MAP signal, and Vref.

MAT Manifold Air Temperature Sensor

A thermistor style sensor used to indicate air temperature after passing through the charge air cooler.

Normally Closed

Refers to a switch or a solenoid that is closed when no control or force is acting on it.

Normally Open

Refers to a switch or a solenoid that is open when no control or force is acting on it.

PCM Powertrain Control Module

The housing which contains the micro computer, Vref regulator, input conditioners and output drivers.

Potentiometer (Pot)

Converts a mechanical motion to a voltage value. Most often used to sense the position of a component. This sensor works as a variable voltage divider. The wiper arm is mechanically connected to the component desired to be sensed. Potentiometers have three connections: Vref, signal out, and ground.

Pulse Width

The length of time an actuator, such as an injector, remains energized.

Split Shot Injector (Prime)

Split shot injectors provide improved exhaust emissions and quiet engine operation by tailoring the injection of fuel, without a decrease in performance.

Thermistor

Sensor used to determine temperature. A thermistor changes its resistance value in relation to temperature change. Increasing temperature results in decreasing resistance, decreasing temperature results in increasing resistance. The thermistor in conjunction with a current limiting resistor in the ECA forms a voltage divider that provides a voltage signal that indicates temperature. Since the top half of the voltage divider is the current limiting resistor and is internal to the ECA, a thermistor sensor only has two connections, signal return and ground.

VBAT

Battery voltage (see VPWR).

VPWR

Battery voltage (see VBAT).

VSS Vehicle Speed Sensor

Normally a magnetic pickup style sensor that is mounted on the tailshaft of the of the transmission to indicate ground speed.

A

Air cleaner, 12
 Air induction hose, 19
 Antifoam concentrate, 47

C

Cam follower guide, 38
 Camshaft, 6
 Charge air cooler
 housing, 15-16
 piping, 18-19

Circuit diagrams, 51, 55, 59, 63, 66-67

Crankcase, 6, 38
 pressure, 10

Crankshaft, 6, 45
 wear sleeve, 45

Cylinder head gasket, 39

D

Diagnostic forms, 70
 Diagnostic guide, 60-61, 64-65
 Dipstick, 10

E

ECM pinouts, 50, 54, 58, 62
 Emission label, 5
 Engine harness, 8, 43
 Engine mounts, 12
 Engine serial number, 4
 Engine torque, 5
 Exhaust back pressure, 9, 13-15
 Exhaust manifolds, 9
 Exhaust pipe, 19
 Exhaust up pipes, 8

F

Flexplate/Flywheel, 12, 48
 Front cover, 39

Fuel filter assembly

 filter element, 25
 heater, 24-26, 36
 pressure regulator, 24, 35
 restriction sensor, 35
 service, 25-26, 35-37
 standpipe, 26
 water drain, 24-25, 37
 water sensor, 25, 36

Fuel inlet check valve, 27

Fuel supply lines, 27, 41

Fuel system diagram, 28

G

Glow plug relay, 43

H

High pressure oil pump, 42

Horsepower, 5

I

Injector, 21-23, 41

 torque, 48

 o-rings, 23

 split shot (prime), 21-22, 41

Injection control regulator, 43

 o-rings, 43

Intake cover, 16, 48

Intake hoses, 16, 47

O

Oil cooler header

 filter bypass valve, 46

 pressure regulator, 46

Oil fill, 10

Oil pan, 40

 capacity, 48

 gasket, 42

 resealing, 47

Oil reservoir, 23, 40

P

Pistons, 7

 rings, 7

Pressure check

 at pump, 29

 left head, 28

 right head, 28

S

Sensors

 camshaft position (CMP), 32, 43, 45

 engine coolant temperature (ECT), 43

 exhaust back pressure (EBP), 32, 43

 injection control pressure (ICP), 43

 manifold air temp (MAT), 31

 manifold absolute pressure (MAP), 31

Snap to connect ICP lines, 29



connections, 29
tools, 30
Sound insulating material, 17

T

Thermostat, 44
Thermostat housing, 11
Torque data, 33
Turbine inlet and clamp, 10, 20
Turbo, 13-15, 20
 Removal, 17-20

U

Under valve cover harness (UVC), 7, 43

V

Valve cover gasket, 7
Valve cover gasket breakout tool, 8

W

Waste gate
 actuator, 16
 control, 15
Water pump, 11, 44
Water pump pulley, 11

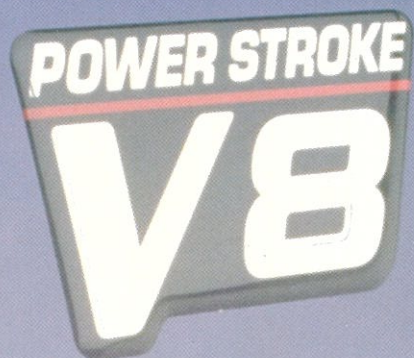

7.3 DIT *Power Stroke*
Direct Injection
Turbocharged Diesel Engine

FSC 12922JA