

advanced FLOW engineering Cold Air Intake System

Instruction Manual P/N: 54-13072KN

Make: RAM

Model: 1500 TRX

Year: 2021-2023

Engine: V8-6.2L (sc)



- Please read the entire instruction manual before proceeding.
- Ensure all components listed are present.
- For technical support please call 951-493-7185.
- Ensure you have all necessary tools before proceeding.
- Do not attempt to work on your vehicle when the engine is hot.
- Retain factory parts for future use.

Label	Qty.	Description	Part Number
A	1	Air Filter (Pro 5R - Black)	24-90202K
B	1	Tube	05-5413072N1
C	1	Housing	05-5413072N2
D	1	Coupling, Silicone Reducer: 108mm x 100mm x 3"L	05-01703
E	2	Clamp, Worm Gear #072	03-50010
F	1	Grommet, Rubber 1"	03-50167
G	1	Fitting, Air Temperature Sensor	05-01454
H	4	Bumper, Rubber: 1/2" ID x 1" OD	03-50769
J	2	Screw, Engraved aFe POWER: M6 x 1.0mm	03-50483
K	2	Grommet, Rubber 3/8" ID x 13/16" OD	03-50783
M	1	Bracket, Drivers Side	05-01741
N	1	Bracket, Passenger Side	05-01738
P	4	Button Head Screw; M6x1.0x16	03-50782
Q	4	Washer, Flat: M6	03-50070
R	4	Washer, Lock: M6	03-50071
S	1	Fitting, 1/2" Barb to 3/8" NPT	03-50794
T	1	Trim Seal (56" Length)	05-01534
U	2	Push Clip: 6.5mm x 22mm	03-50773
V	1	Hose, Silicone Breather: 1/2" ID, Black (8" Length)	05-01396

Installation will require the following tools:

Trim removal tool, Ratchet, 12" Ratchet Extension, 10mm, 13mm, 8mm sockets, T30 Torx driver, Razor blade, 3mm Allen key

Warranty Information available at <https://afepower.com/contact#warranty>

Emissions Disclaimer: This product is not currently CARB exempt and is not available for purchase in California or for use on any vehicle registered with the California Department of Motor Vehicles.

NOTE: All Installation photos are of the black version of this kit. All steps are the same.

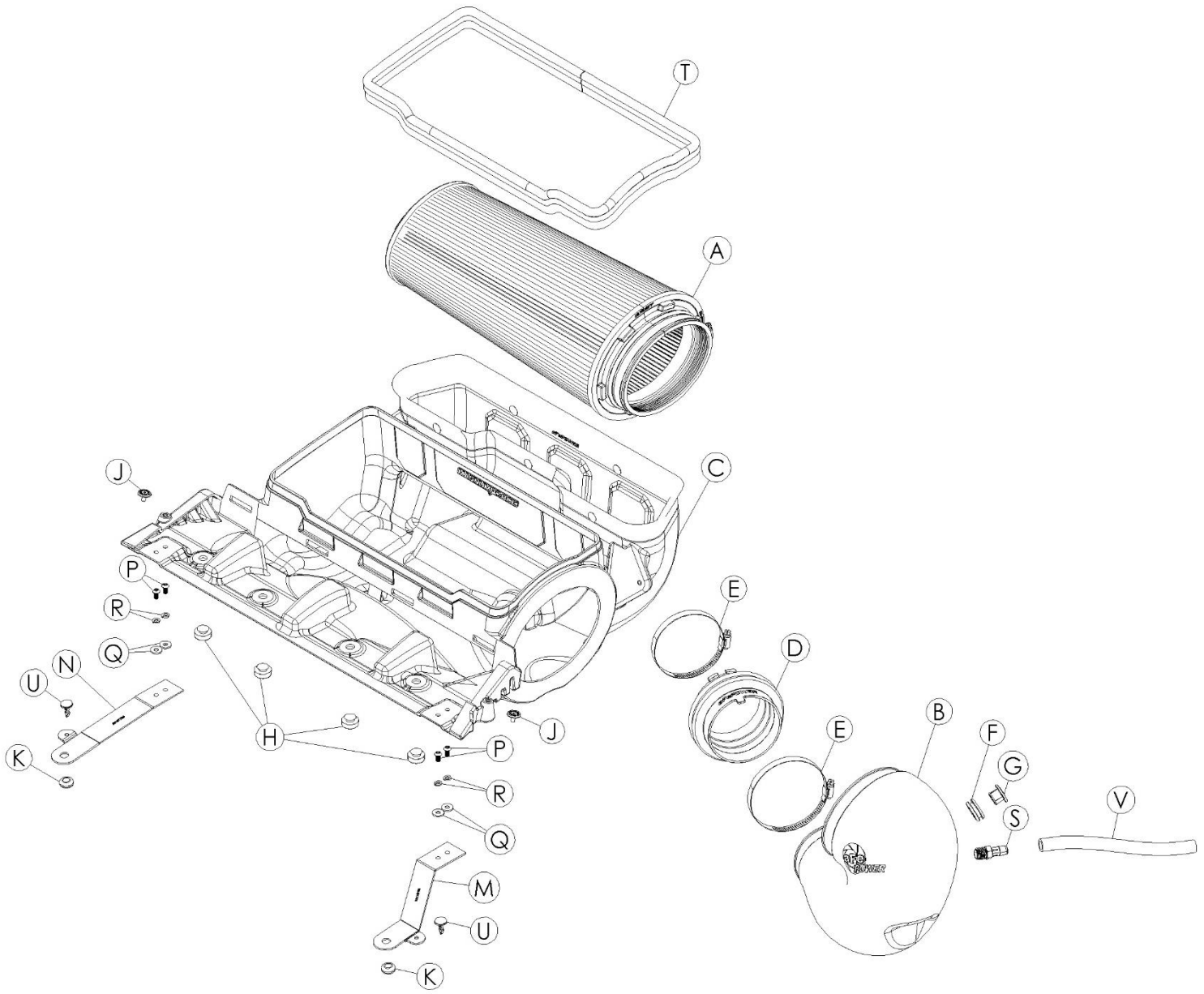
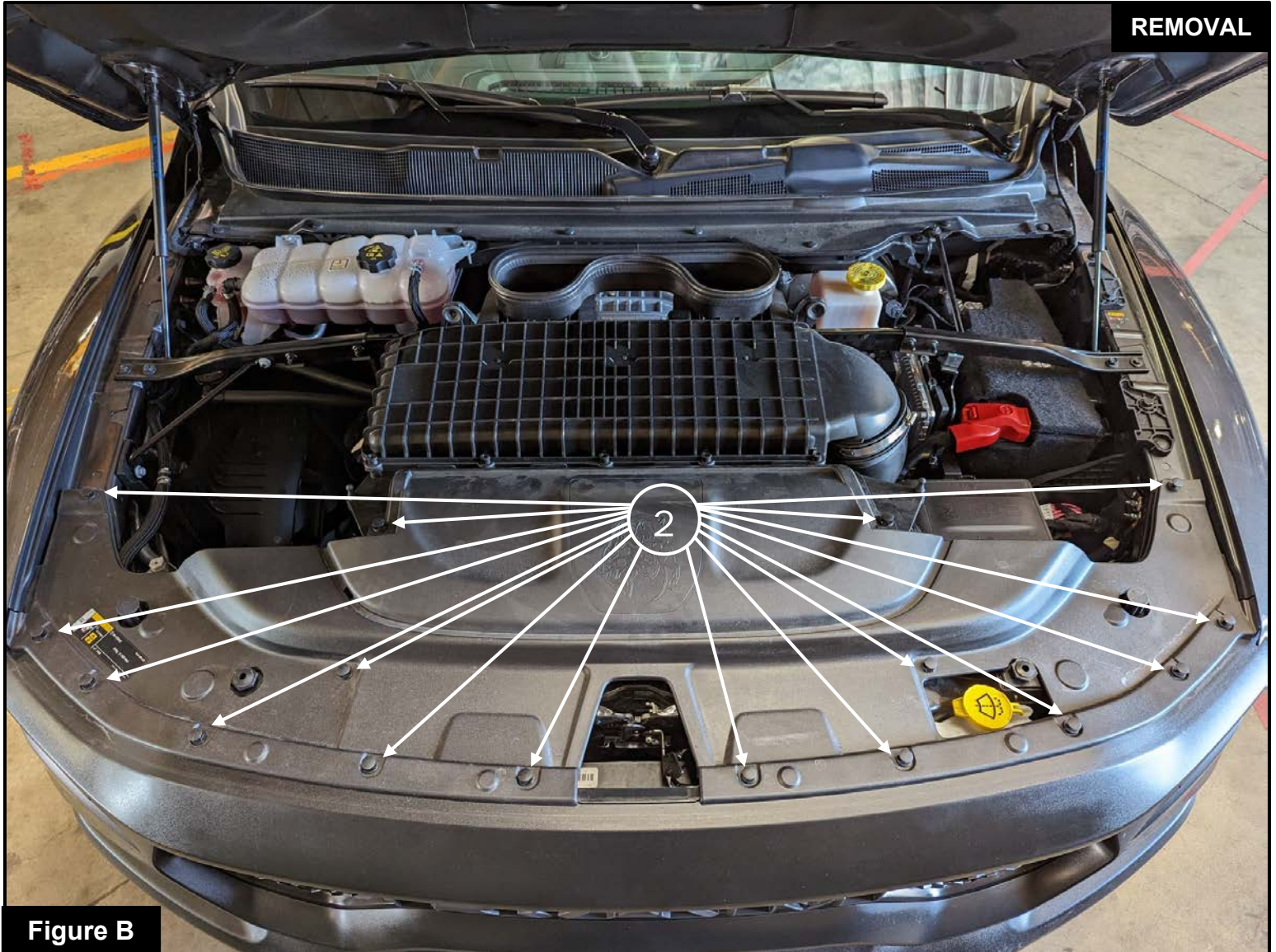



Figure A

Refer to Figure A for Step 1

Step 1: Remove your engine cover ①.

**Figure B****Refer to Figure B for Step 2**

Step 2: Using a small trim removal tool, remove the sixteen (16) clips ② securing the factory front cowl, then remove the cowl.

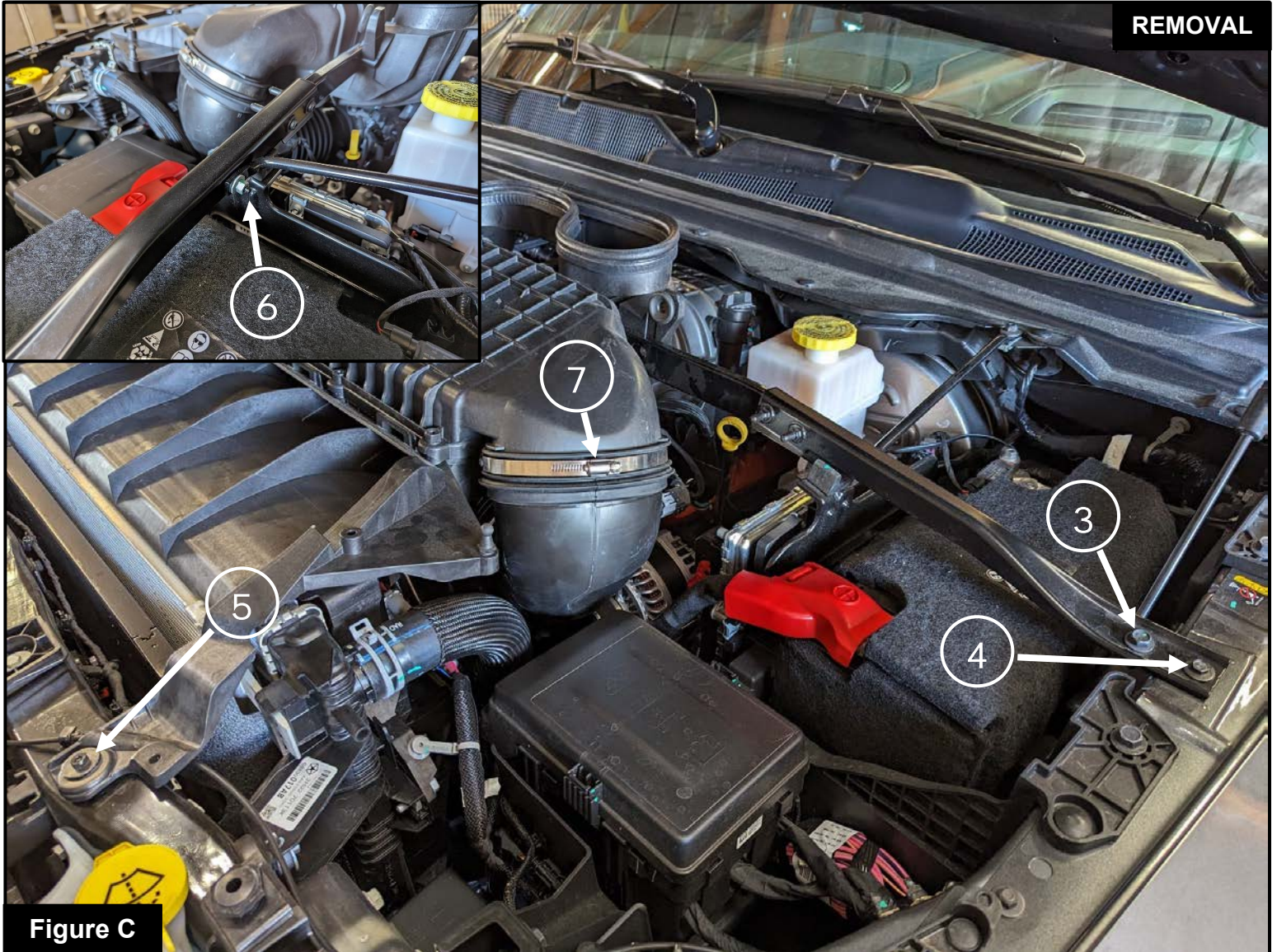

REMOVAL

Figure C

Refer to Figure C for Steps 3-5

Step 3: On the driver side of the vehicle, use a 13mm socket and driver to remove the larger screw (3) securing the factory intake brace.

Step 4: Using a 10mm socket and driver, remove the smaller screw (4) securing the factory intake brace as well as the screw (5) securing the factory intake to the core support in the front of the vehicle. Remove the single nut (6) on the back side of the intake brace using a 10mm socket and driver.

Step 5: Using an 8mm socket and driver, loosen the clamp (7) at the factory air intake tube and disconnect it from the factory airbox.

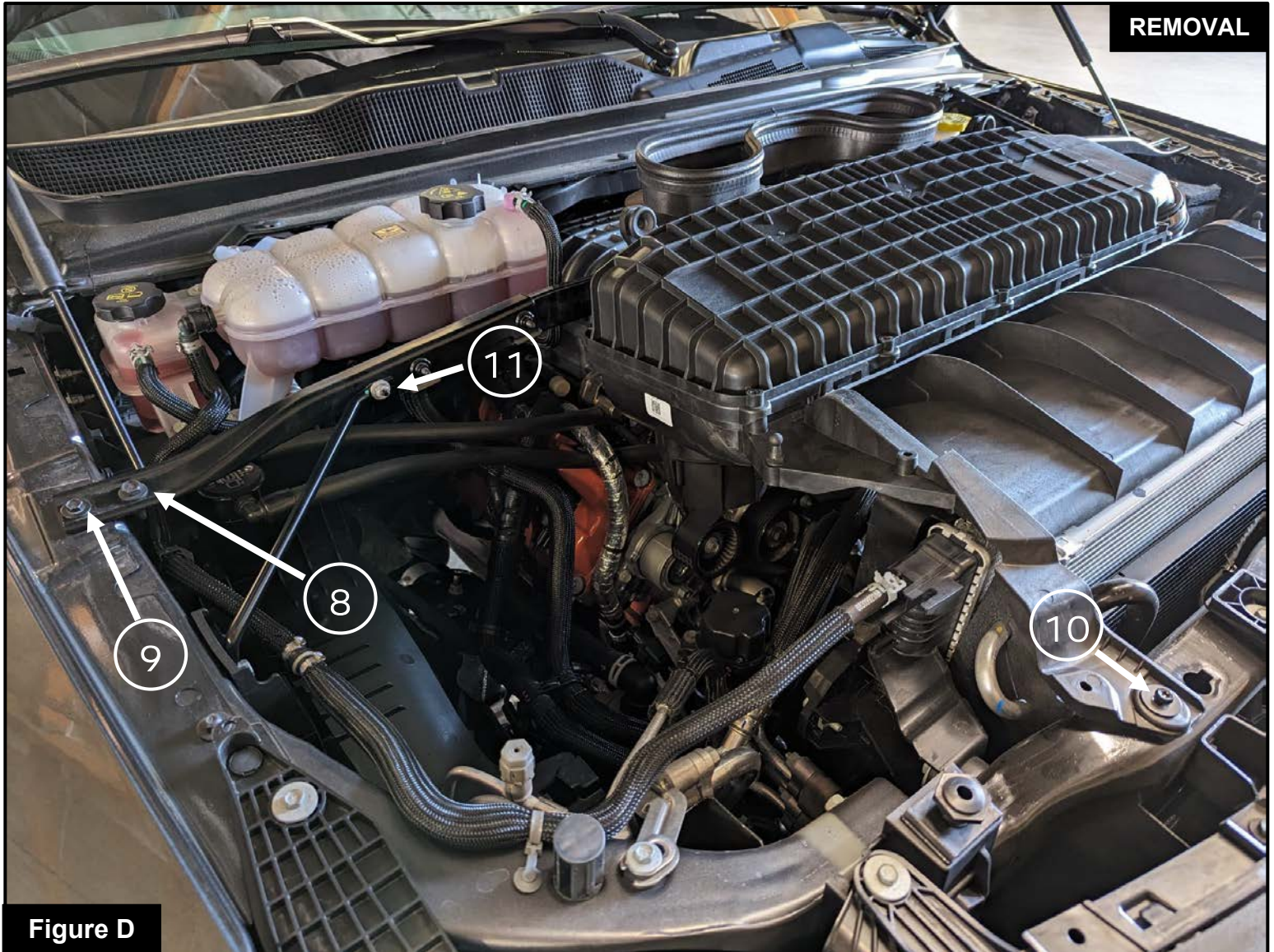

Figure D

Refer to Figure D for Steps 6-8

Step 6: On the passenger side of the vehicle, use a 13mm socket and driver to remove the larger screw (8) securing the factory intake brace.

Step 7: Using a 10mm socket and driver, remove the smaller screw (9) securing the factory intake brace as well as the screw (10) securing the factory intake to the core support in the front of the vehicle. Remove the single nut (11) on the front side of the intake brace using a 10mm socket and driver.

Step 8: Carefully lift the factory air intake and brace out of the vehicle leaving the intake tube in the vehicle.

**Figure E****Refer to Figure E for Step 9**

Step 9: Transfer the rubber drain (12) from the factory airbox to the hole on the bottom of your aFe POWER filter housing.

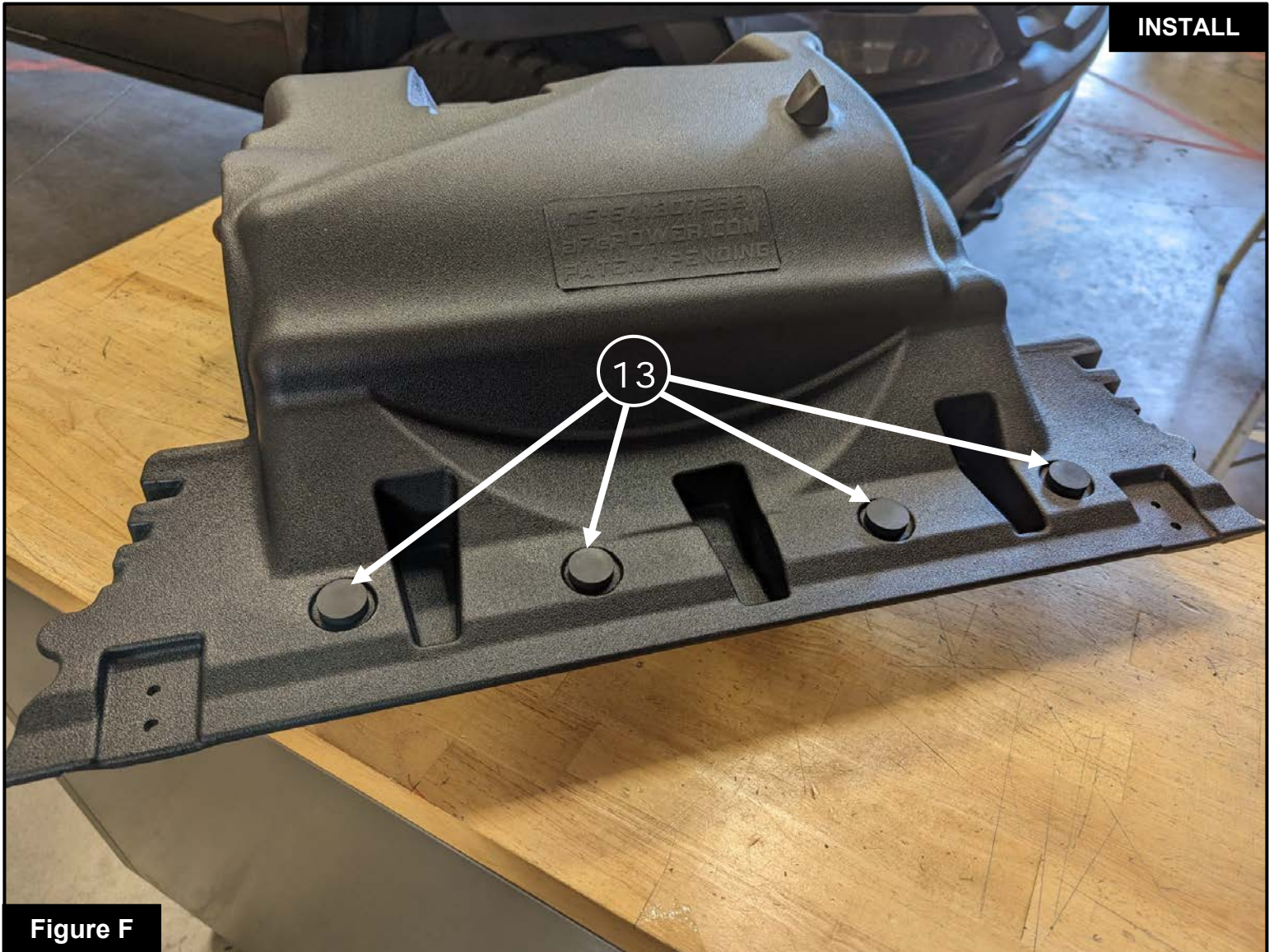
**Figure F****Refer to Figure F for Step 10**

Step 10: Install the four (4) supplied rubber bumpers ⑬ into the ½” holes on your aFe POWER filter housing with the large padded side towards the bottom as shown.

**Figure G****Refer to Figure G for Steps 11-12**

Step 11: Install the supplied brackets (14) onto your aFe POWER housing as shown with the bracket mounting tabs towards the outside of the housing. Secure the brackets with the provided M6 screws and washers, placing the lock washer between the flat washer and the screw head.

Step 12: Install the supplied rubber grommets (15) into the larger holes at the front of the brackets.

**Figure H****Refer to Figure H for Step 13**

Step 13: Install the supplied length of trim seal along the edge of your aFe POWER filter housing. Trim as needed for proper fitment.

**Figure I****Refer to Figure I for Step 14**

Step 14: Using an 8mm socket and driver with an extension, loosen the ten (10) screws ⑯ sealing the factory airbox and remove the lid.

**Figure J****Refer to Figure J for Step 15**

Step 15: Using a T30 Torx driver, remove the four (4) screws (17) securing the intake brace to the factory airbox and remove the brace.

**Figure K****Refer to Figure K for Step 16**

Step 16: Install the factory intake brace onto your aFe POWER filter housing using two (2) of the T30 Torx screws **18** removed in the previous step. Do not overtighten the screws.

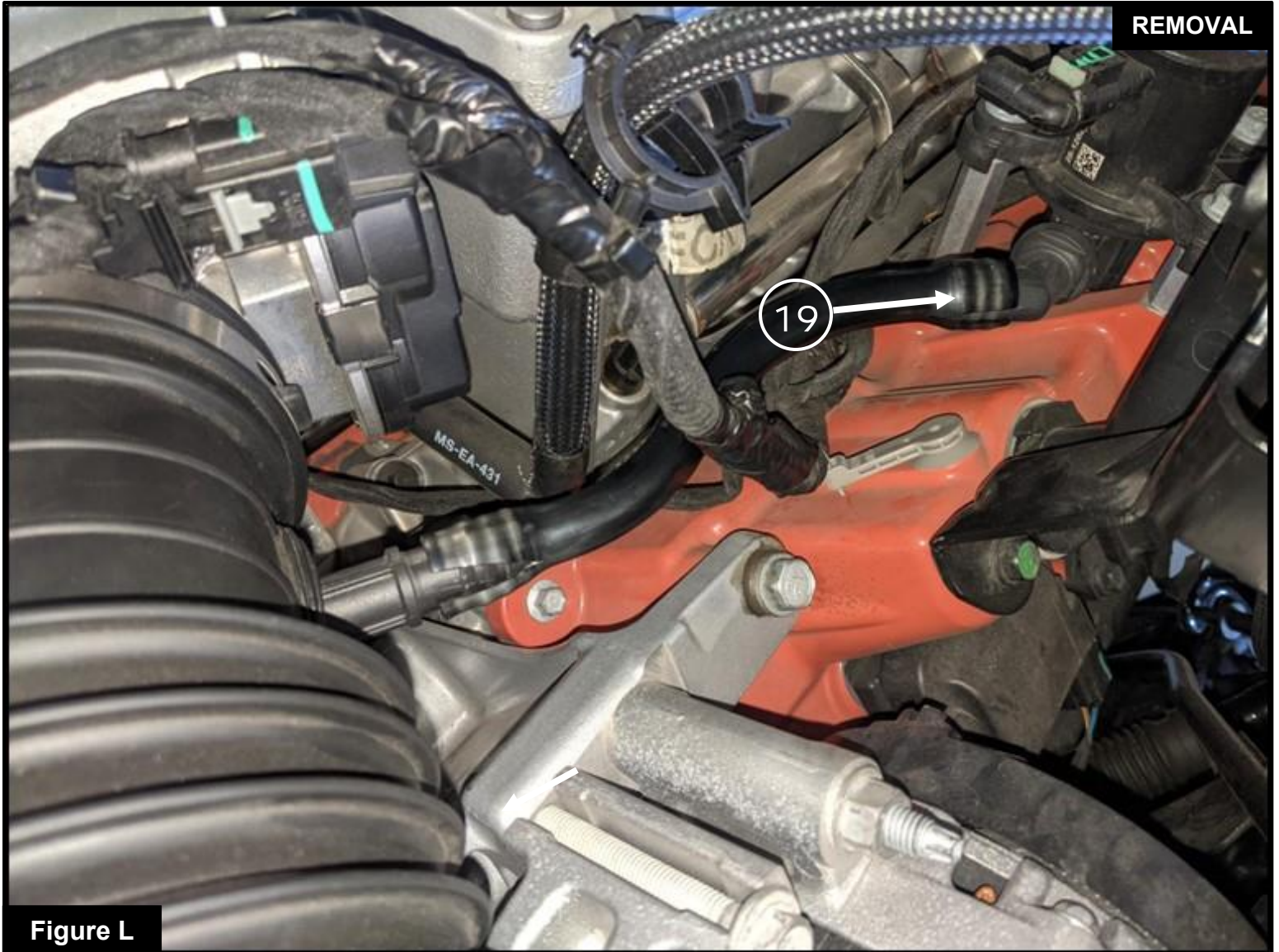

Figure L

Refer to Figure L for Steps 17

Step 17: Using a razor blade, carefully cut the plastic line (19) connected to the MUA system on the valve cover. If you ever need to reinstall the factory intake, we recommend using heat-shrink to cover the cut section of the plastic line.

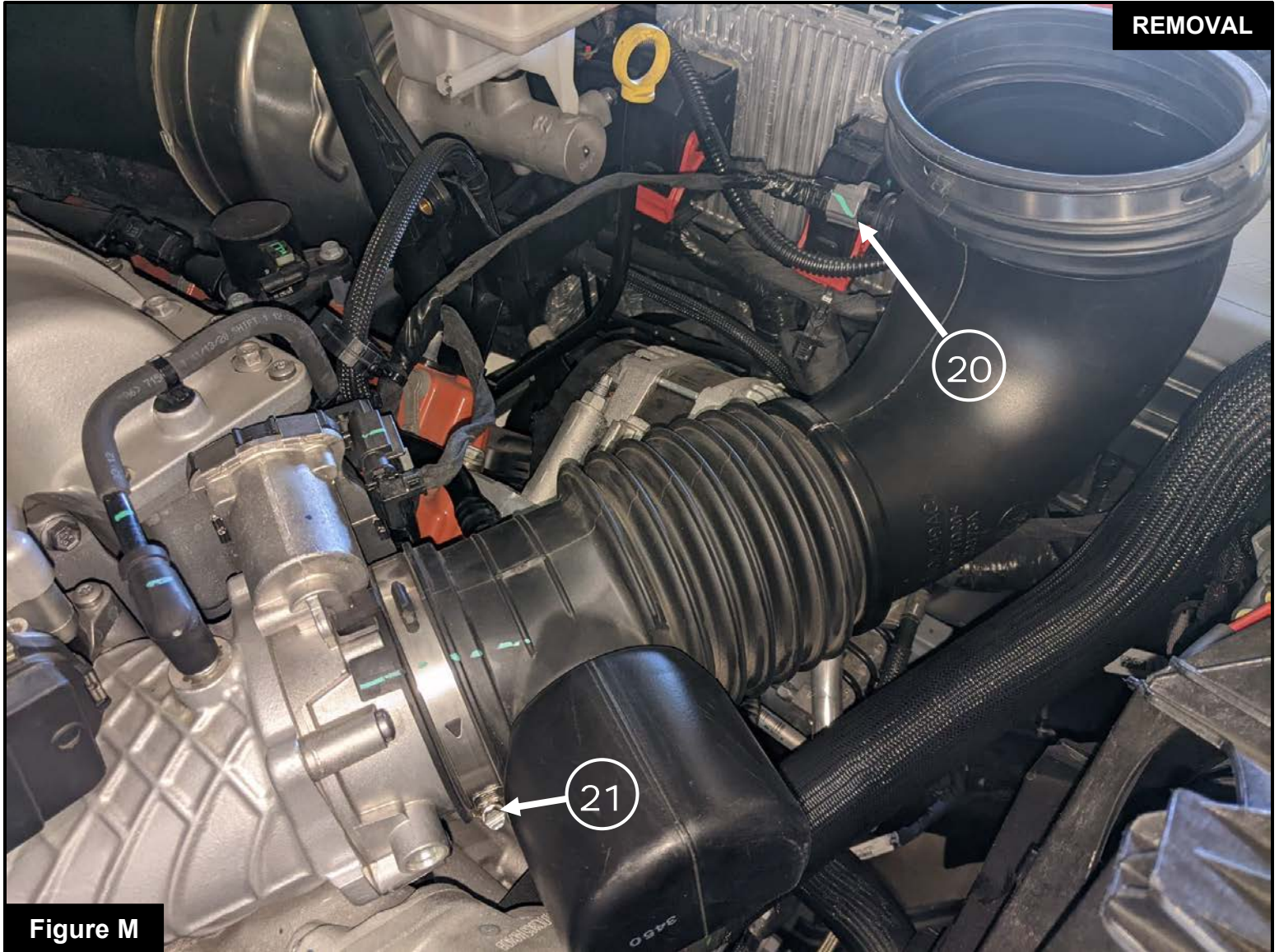

Figure M

Refer to Figure M for Steps 18-19

Step 18: Disconnect the temperature sensor wire harness (20) from the sensor on the factory intake tube.

Step 19: Using an 8mm socket and driver, loosen the clamp at the throttle body (21) then remove the factory air intake tube.

**Figure N****Refer to Figure N for Steps 20-21**

Step 20: Install the supplied 1" rubber grommet and temperature sensor fitting (22) into the air intake tube.

The arrow on the fitting should be pointed in the direction of airflow in the tube.

Step 21: Install the supplied barbed fitting (23) into the insert on the air intake tube. Tighten the fitting using a 17mm deep socket and driver. Do not overtighten the fitting – this is a pipe thread fitting, so some threads will be exposed when fully tightened.

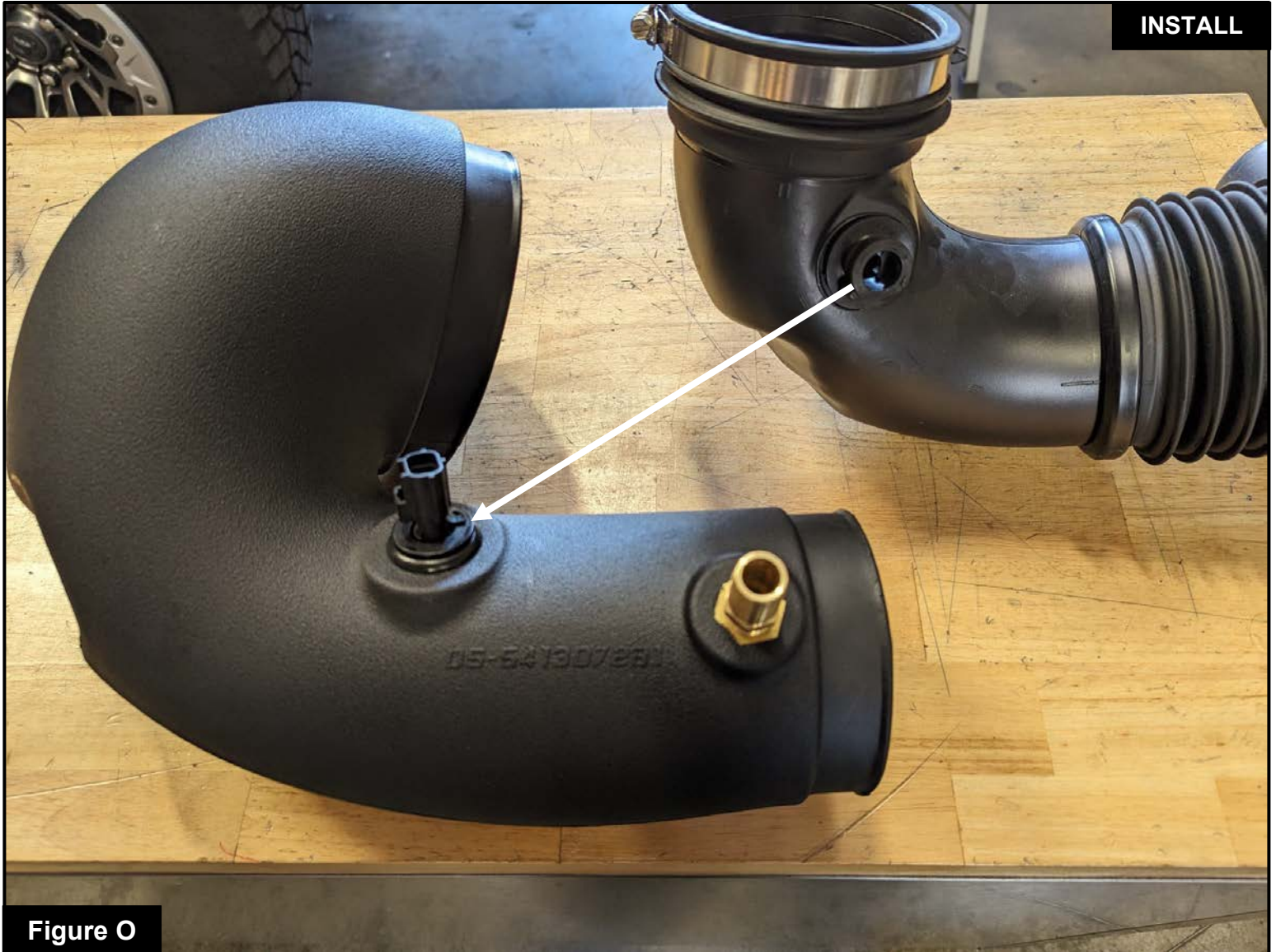
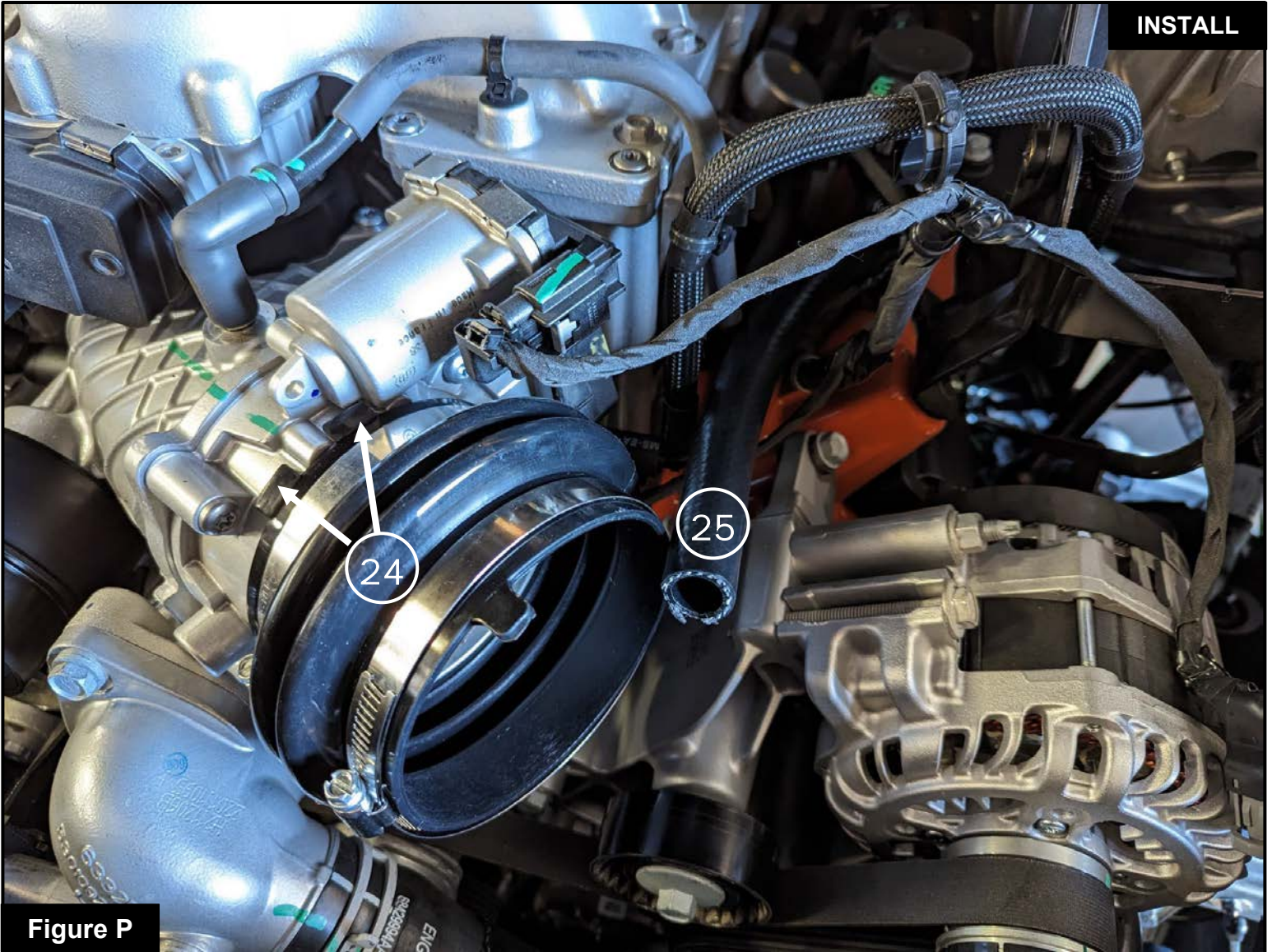

Figure O

Refer to Figure O for Step 22

Step 22: Transfer the temperature sensor from the factory air intake tube to your aFe POWER air intake tube. To remove the sensor, rotate a quarter turn counter-clockwise and pull it out of the sensor fitting. To reinstall, line up the locking tabs on the aFe POWER sensor fitting, press the sensor in until the tab sits flush with the surface of the fitting, then rotate clockwise until the sensor tab locks into place.

Figure P

Refer to Figure P for Steps 23-24

Step 23: Install the supplied bellow coupling with the smaller side on the throttle body making sure the indexing tabs (24) are straddling the index on the top of the throttle body as shown. Once aligned, secure the coupling with one of the supplied #072 clamp and tighten using an 8mm nut driver. Place the remaining worm clamp loosely on the open end of the coupling.

Step 24: Install the supplied length of hose (25) onto the MUA system as shown.

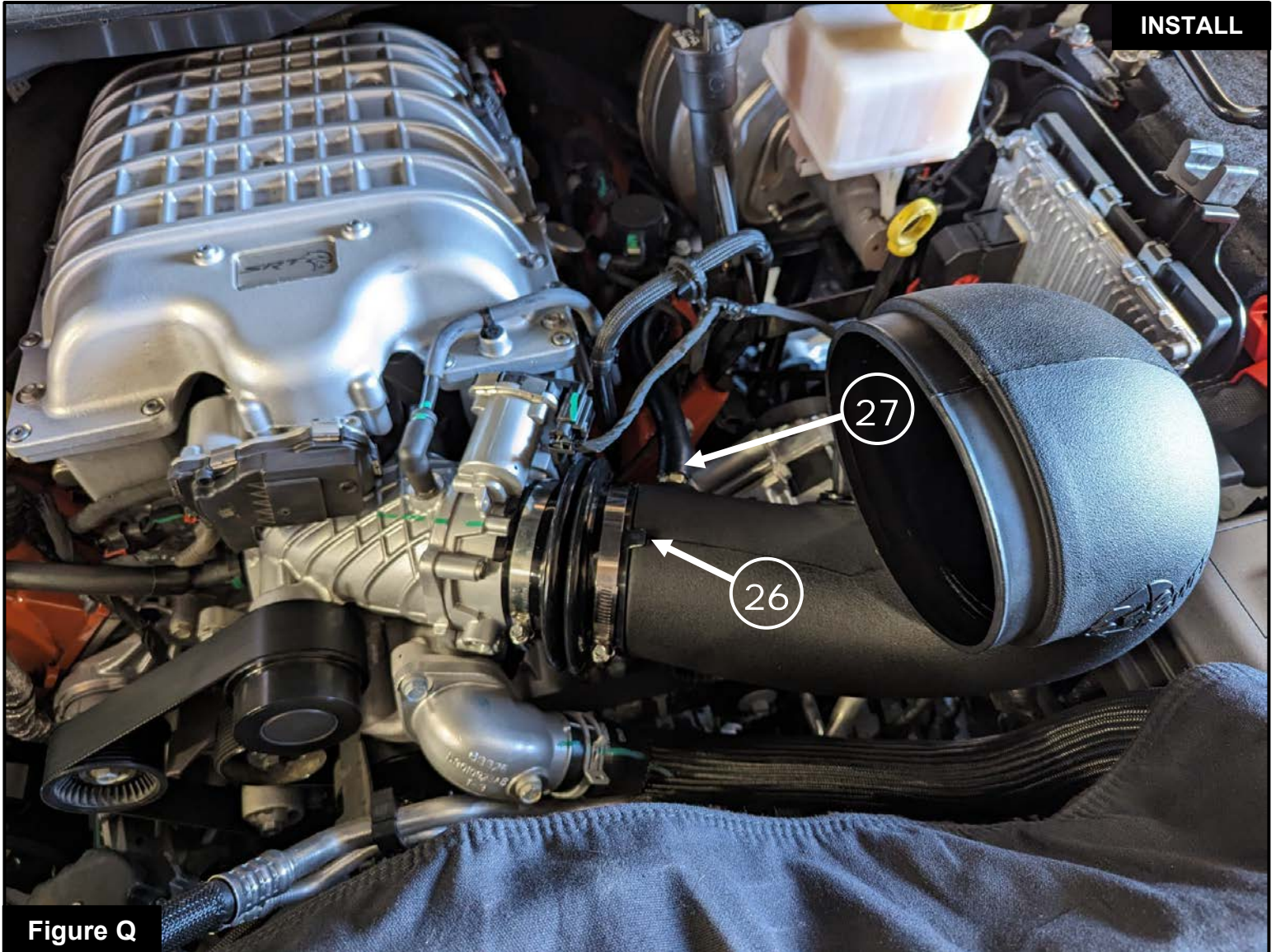
**Figure Q****Refer to Figure Q for Steps 25-26**

- Step 25: Install the intake tube assembly into the coupler at the throttle body with the remaining worm gear clamp, lining up the index on the coupler (26) with the index on the tube. Tighten using an 8mm nut driver
- Step 26: Connect the open end of the previously installed hose (27) to the fitting on the intake tube.



Figure R

Refer to Figure R for Step 27

Step 27: Install your aFe POWER air filter into your housing assembly by sliding the opening on the filter through the hold on the side of your filter housing, then gradually pulling the lip through the opening to secure it in place. Reinstall the filter clamp and leave it loose when finished.

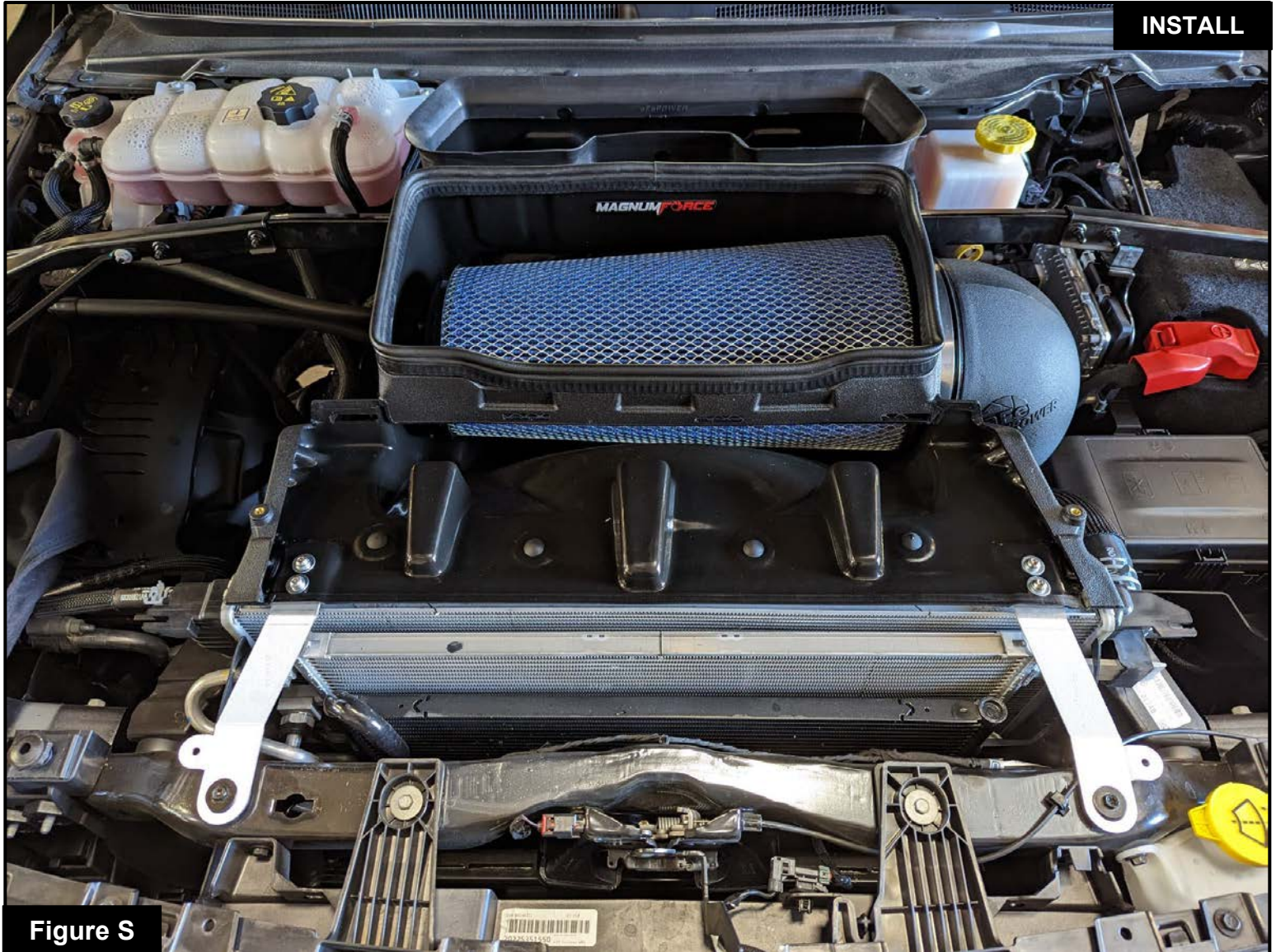
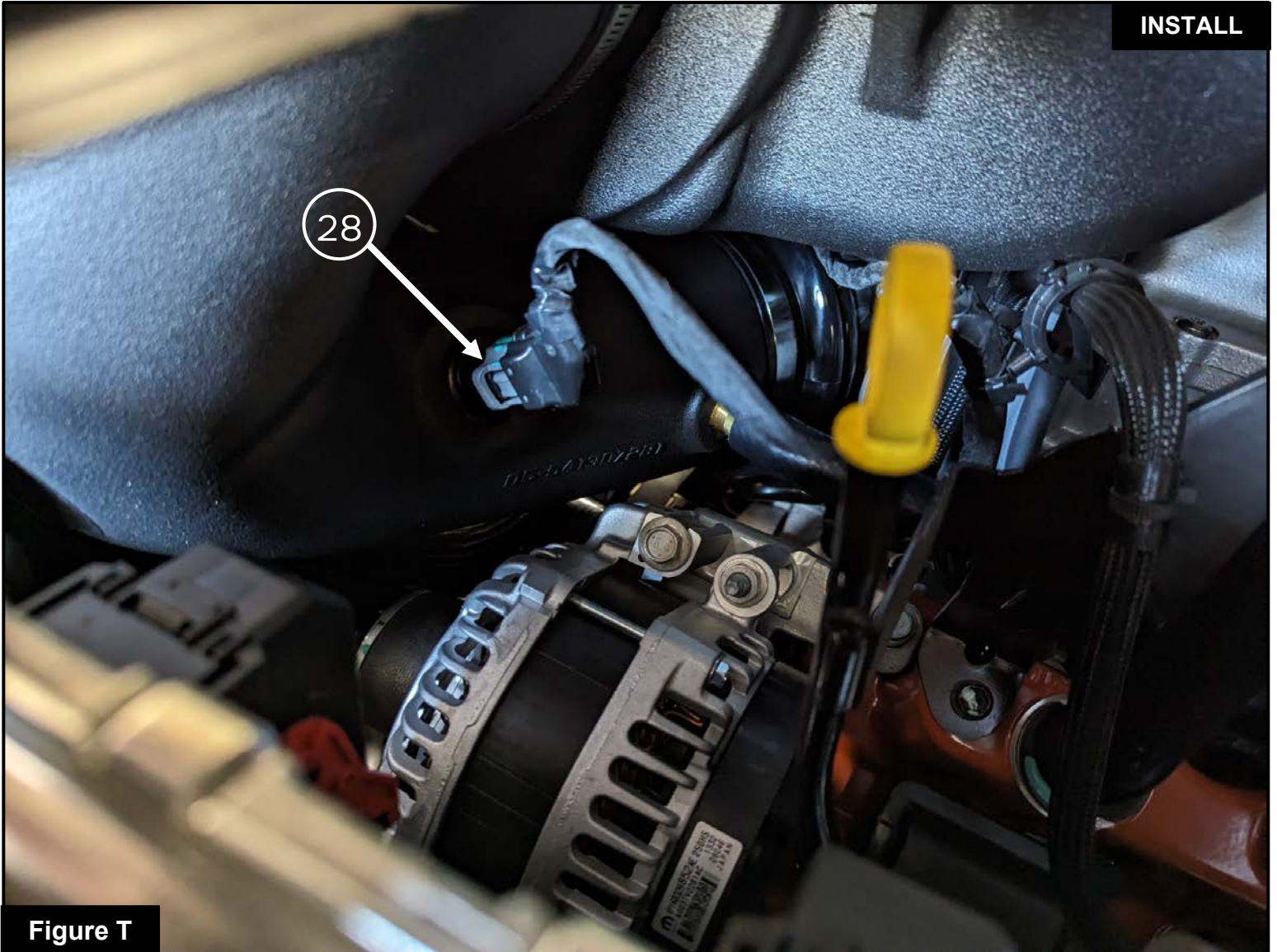

Figure S

Refer to Figure S for Steps 28-29

Step 28: Install your aFe POWER housing assembly back into the vehicle by following steps 3-7 in reverse order, using the factory hardware.

Step 29: Once the housing assembly is installed, insert the open end of your aFe POWER intake tube into the filter opening. Once secure, tighten the remaining worm clamp using an 8mm nut driver.

**Figure T****Refer to Figure T for Step 30**

Step 30: Reconnect the temperature sensor wire harness (28) to the sensor on the back side of your aFe POWER intake tube.

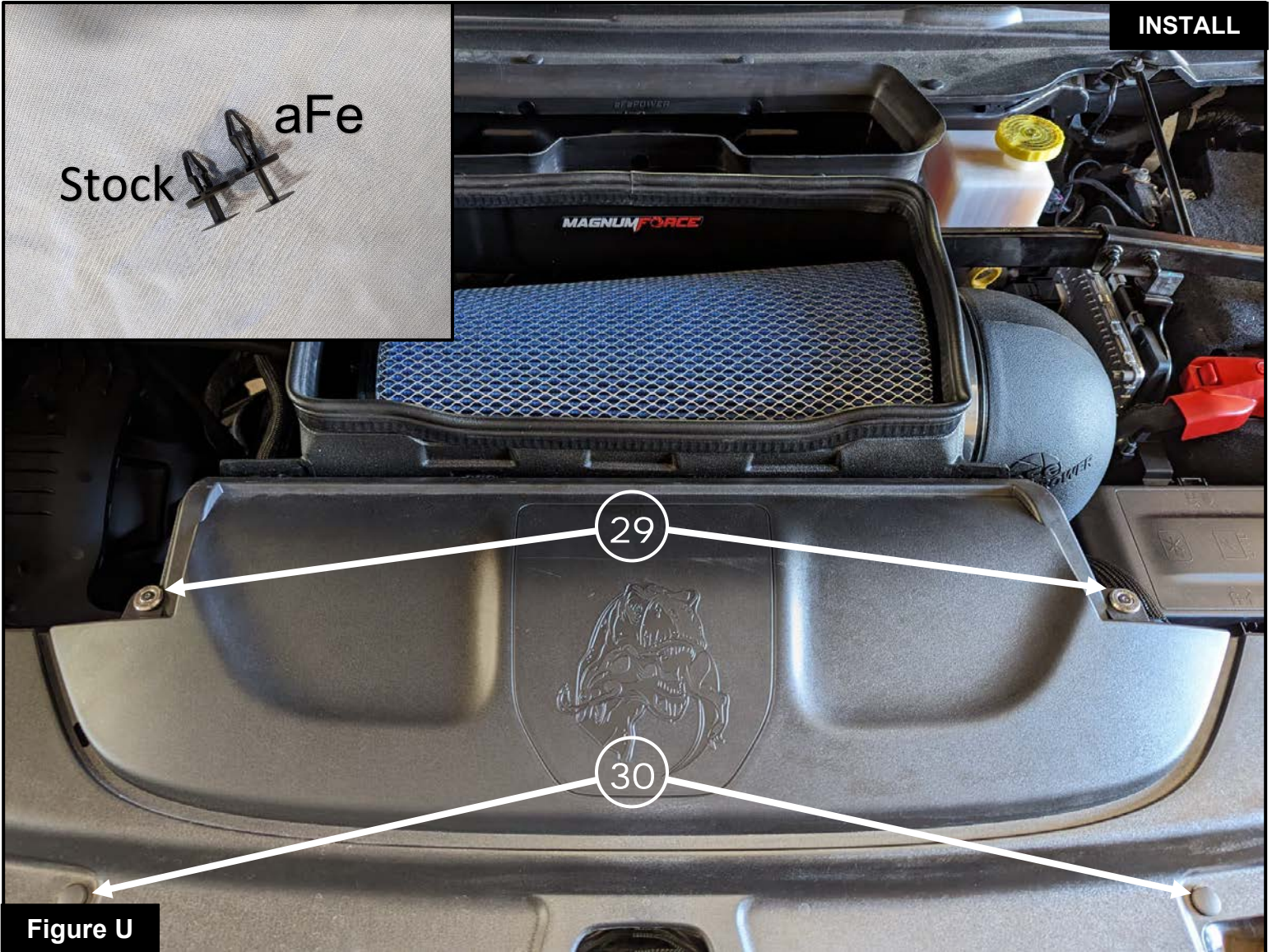

Figure U

Refer to Figure U for Steps 31-32

Step 31: Reinstall the factory cowl on the front of the truck. Secure the cowl first using the two (2) supplied M6 screws and washers (29) in the top holes that line up on the housing. Use a 3mm allen key to tighten the screws.

Step 32: Install the supplied 22mm push clips (the longer clips) into the two (2) locations (30) above the housing brackets.

**Figure V****Refer to Figure V for Step 33**

Step 33: Using the rest of the clips removed in step #2, secure the cowl to the front of the vehicle. There should be 4 factory clips remaining when the installation is complete.

Your installation is now complete. Thank you for choosing aFe POWER!

NOTE: Check all screws, clamps, and connectors are secure after 100-200 miles.



THIS PAGE LEFT BLANK INTENTIONALLY



THIS PAGE LEFT BLANK INTENTIONALLY



advanced FLOW engineering, inc.

Corona, CA 92879

<https://afepower.com/contact>