

Do not discard packaging until product has been successfully installed.

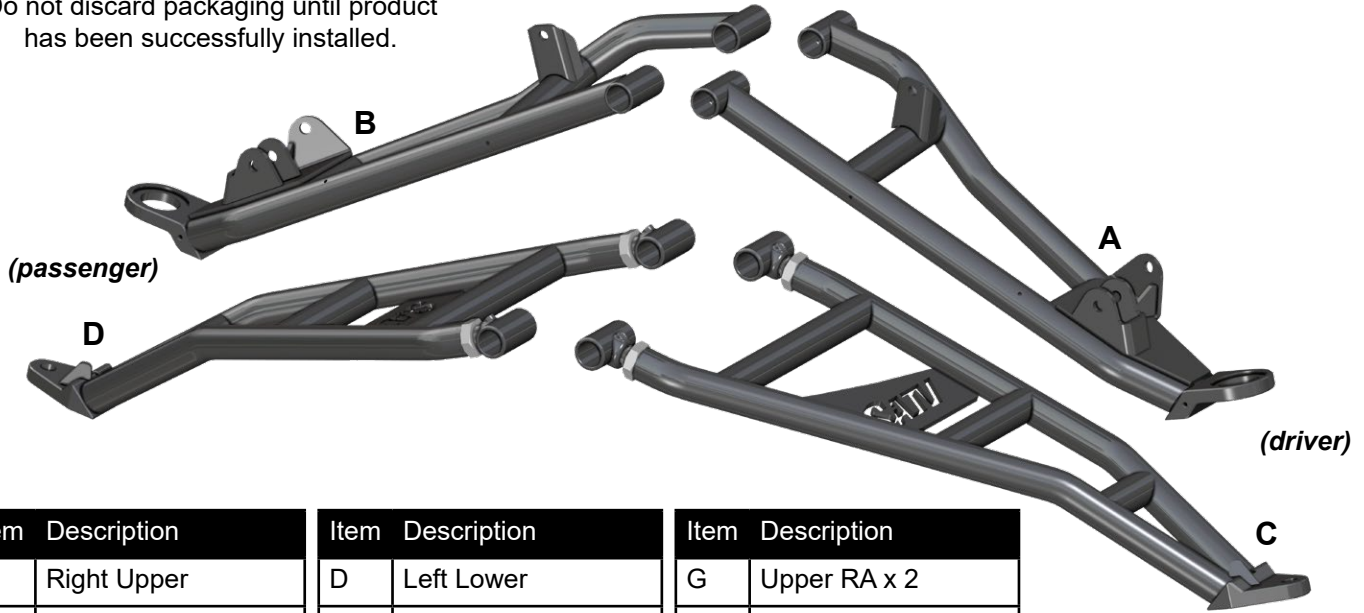

Item	Description	Item	Description	Item	Description
A	Right Upper	D	Left Lower	G	Upper RA x 2
B	Left Upper	E	Right Trailing Arm	H	Lower Inner RA x 2
C	Right Lower	F	Left Trailing Arm	J	Lower Outer RA x 2

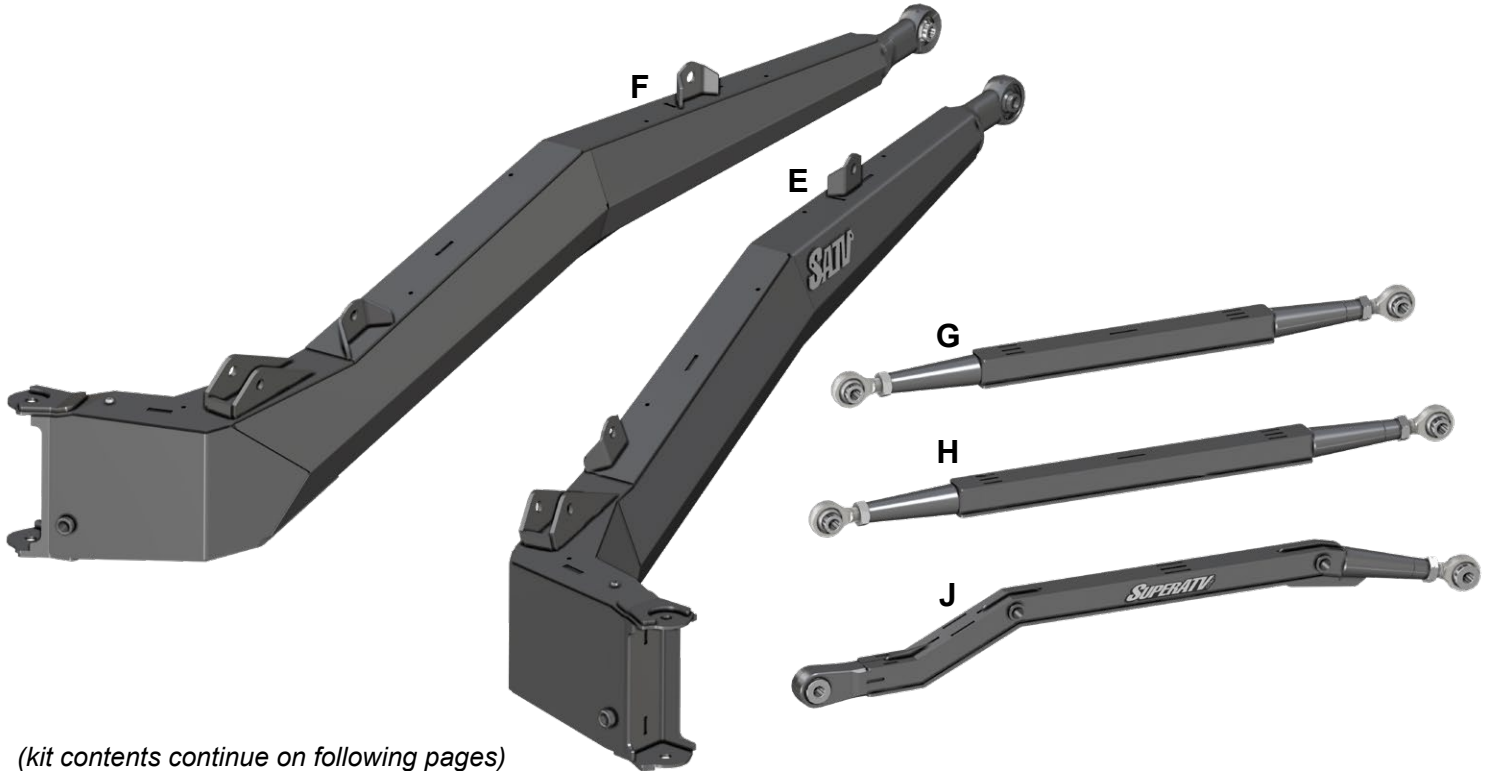

(kit contents continue on following pages)

Need help with your installation?



sales@superatv.com



www.superatv.com



1-855-743-3427



8:00am - 8:00pm EST M-Th
8:00am - 7:00pm EST Friday
9:00am - 2:00pm EST Saturday

Read instructions and view illustrations before beginning.

Thank You
For Choosing



(kit contents continued)

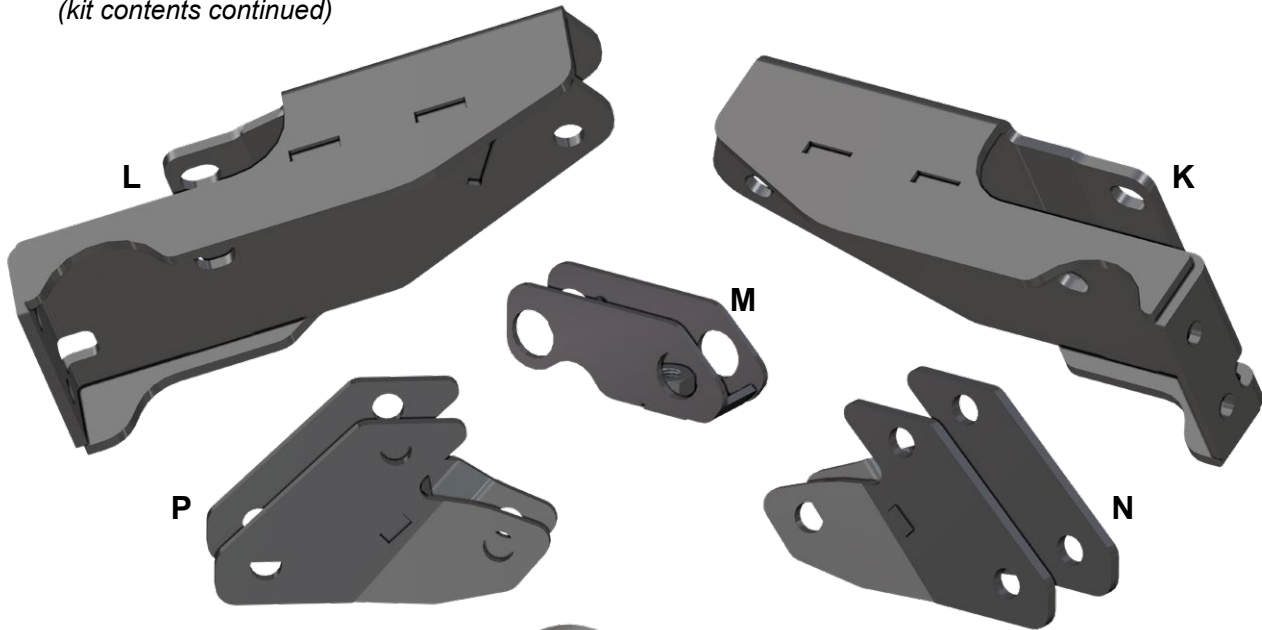

Item	Description
K	Right Shock Mount
L	Left Shock Mount
M	Inner Rear Shock Mount x 2
N	Outer Right Shock Mount
P	Outer Left Shock Mount



Rear Spacer x 2

SuperATV strongly recommends using a Spring Compressor, not included, when removing and installing Rear Spacers.



2 x Tie Rod Shaft



Boot x 2



2 x Ball and Socket



2 x Tie Rod End and Jam Nut

4 x Zip Tie



hardware

(kit contents continued)

2 x Steering Stop



2 x Wire Tie



Front Left Brake Line



Front Right Brake Line

Front Axle x 2



Rear Axle x 2



Liability Statement

SuperATV's® products are designed to best fit user's ATV/UTV under stock conditions. Adding, modifying, or fabricating any factory or aftermarket parts will void any warranty provided by SuperATV® and is not recommended. SuperATV's® products could interfere with other aftermarket accessories. If user has aftermarket products on machine, contact SuperATV® to verify that they will work together.

Although SuperATV® has thousands of satisfied customers, user should be aware that installing lift kits, long travel, or suspension kits, tires, etc. will change the ride of machine and may increase maintenance and part wear. Operating any off-road machine while, or after, consuming alcohol and/or drugs increases risk of bodily harm or death. No warranty or representation is made as to this product's ability to protect user from severe injury or death. SuperATV® urges operators and occupants to wear a helmet and appropriate riding gear at all times.

By purchasing and installing SuperATV® products, user agrees that should damages occur, SuperATV® will not be held responsible for loss of time, use, labor fees, replacement parts, or freight charges. SuperATV®, nor any 3rd party, will not be held responsible for any direct, indirect, incidental, special, or consequential damages that result from any product purchased from SuperATV®. The total liability of seller to user for all damages, losses, and causes of action, if any, shall not exceed the total purchase price paid for the product that gave rise to the claim.

SuperATV® will warranty only parts provided by SuperATV®. Any damage or problems with OEM housings, bearings, seals, or other manufacturers' products will not be covered by SuperATV®. SuperATV® parts and products are not warrantied if item was not installed properly, misused, or modified.

Installing, adding, modifying, or fabricating any factory or aftermarket product to your ATV/UTV may violate certain local, state, and federal laws. Be advised that laws vary depending on town, city, county, state, etc. Use of certain products on public streets, roads, or highways may be in violation law. The Buyer is solely and exclusively legally and personally responsible for any violation of the law by the installation or use of the product. You must abide by all local, state, and federal laws, including but not limited to vehicle safety, traffic laws, and ordinances. It is your responsibility to know the laws and how they apply to you.

The Buyer is responsible to fully understand the capability and limitations of his/her vehicle according to manufacturer specifications, warnings and instructions and agrees to hold SuperATV® harmless from any damage resulting from failure to adhere to such specifications, warnings and/ or instructions. The Buyer is also responsible to obey all applicable federal, state, and local laws and ordinances when operating his/her vehicle while using this product, and the Buyer agrees to hold SuperATV® harmless from any violation thereof.

remove stock front components shown;

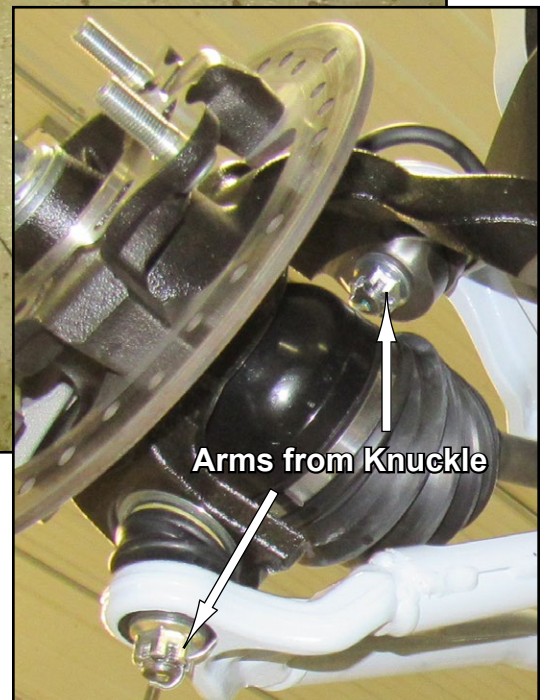
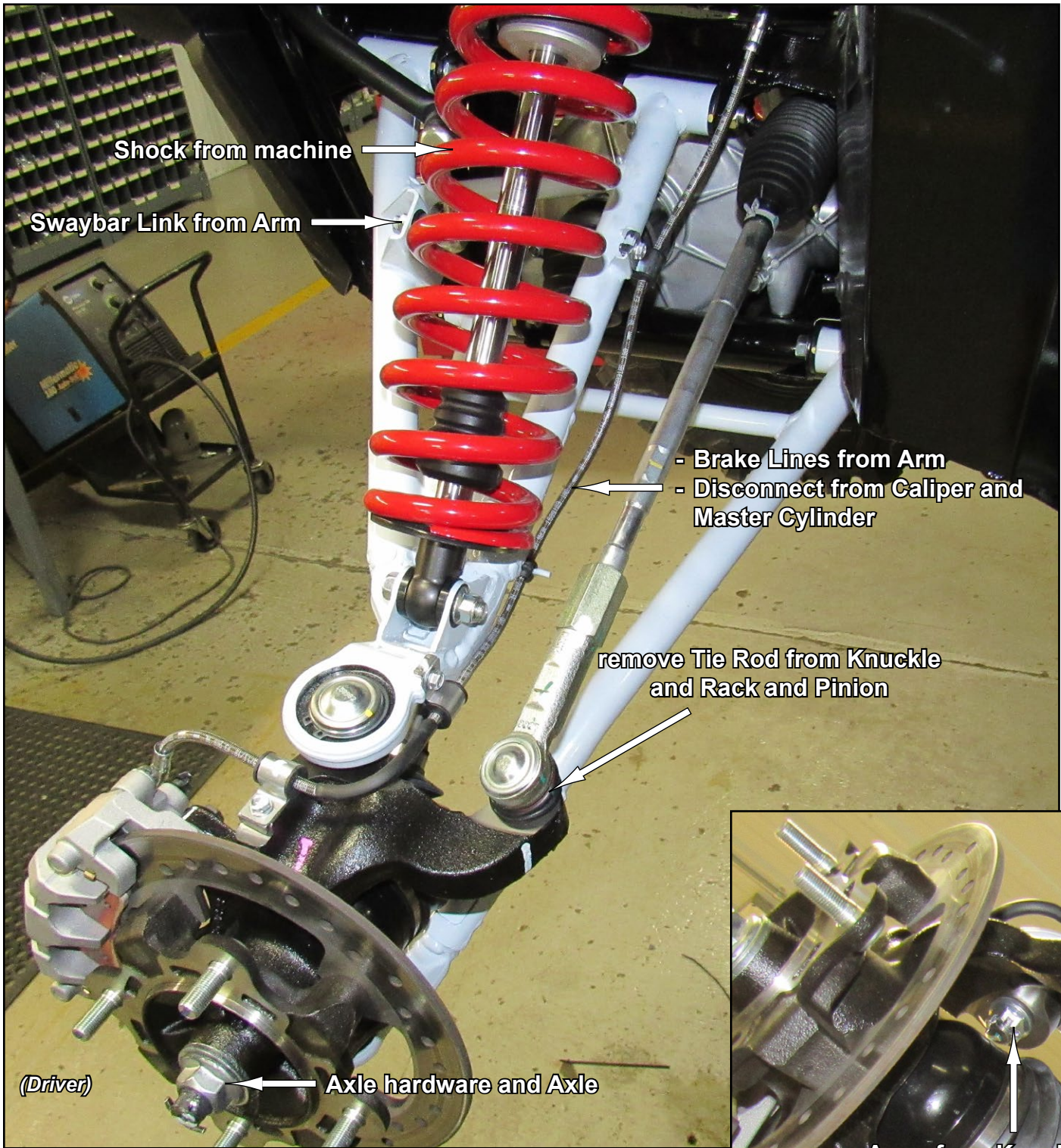

- remove Arms from Frame; repeat for opposite side
- use a press and remove Ball Joints from Upper Arms

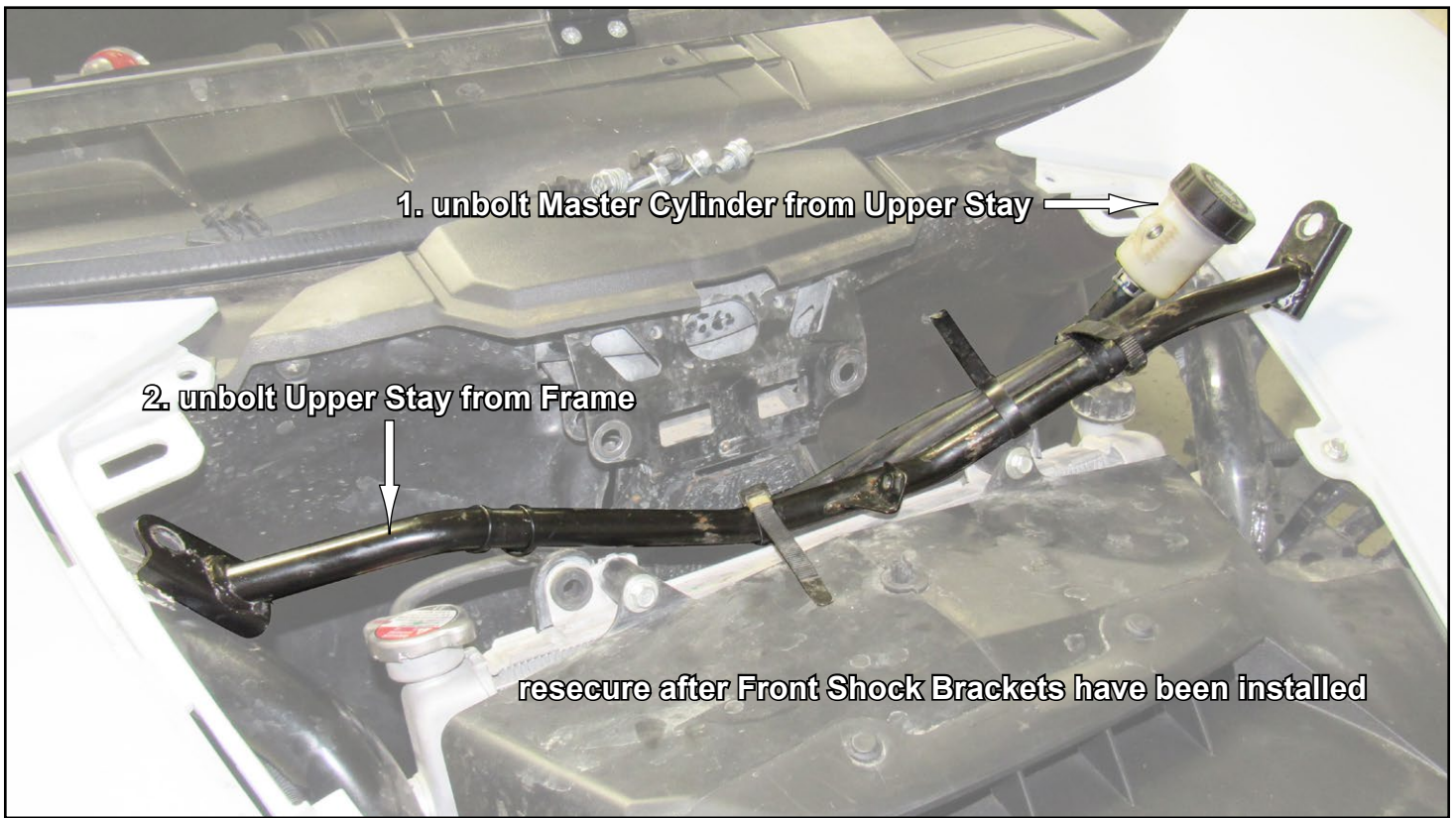

remove stock rear components shown;

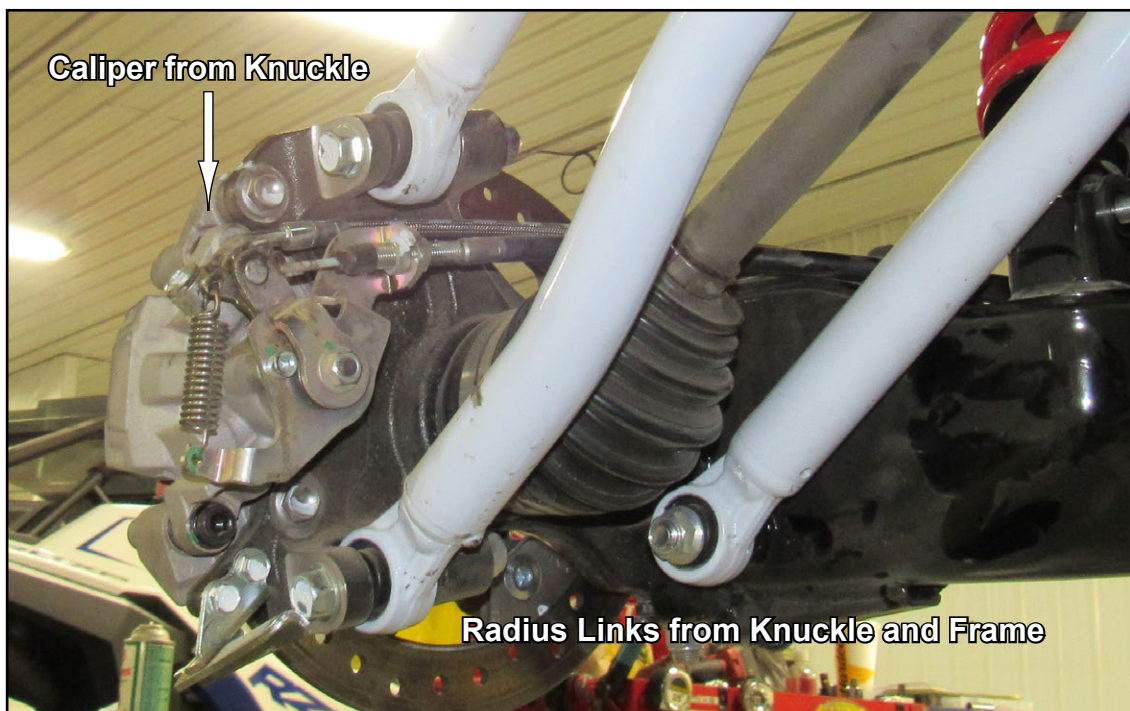
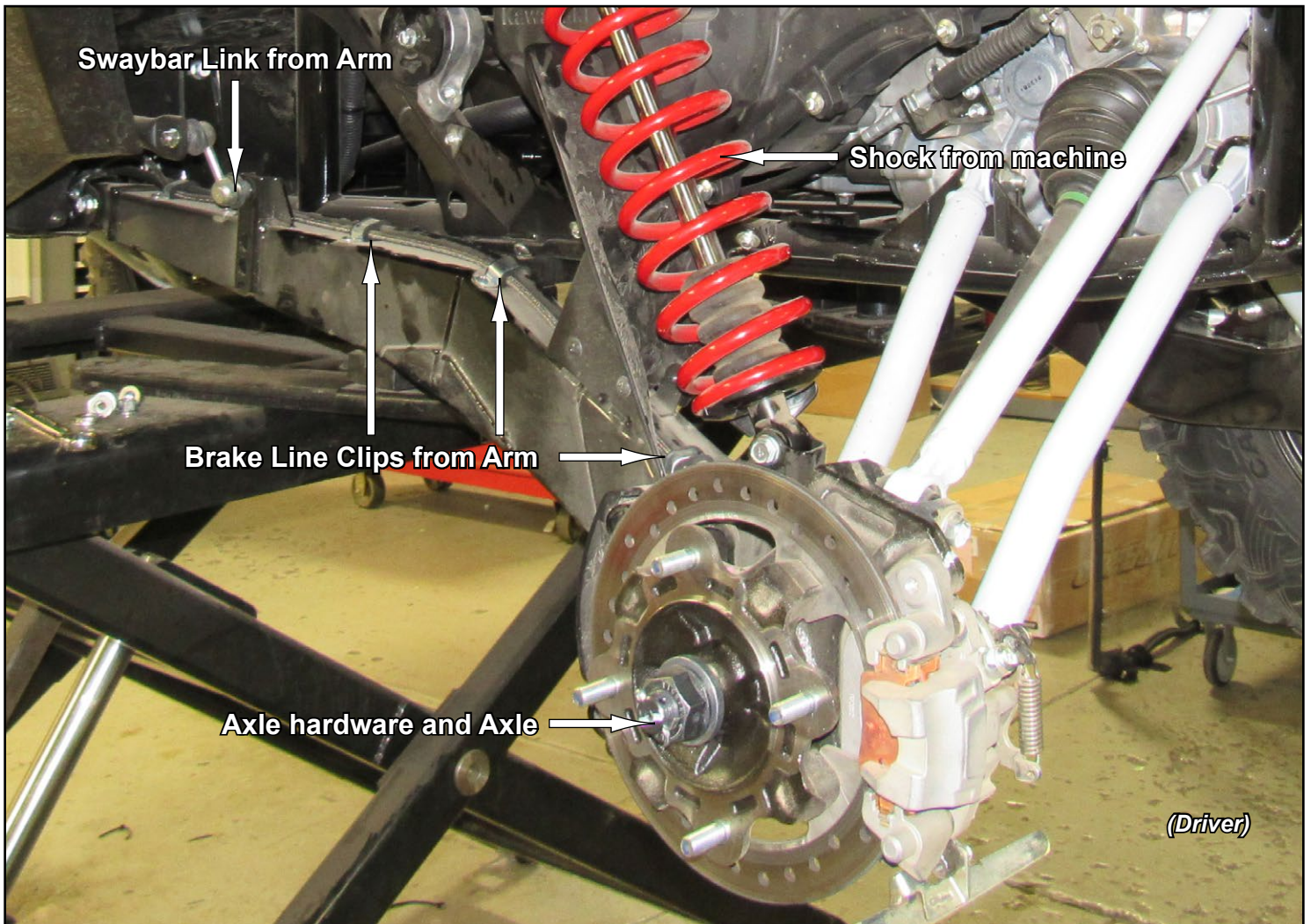

remove Trailing Arm from Frame and repeat for opposite side

install provided Fittings

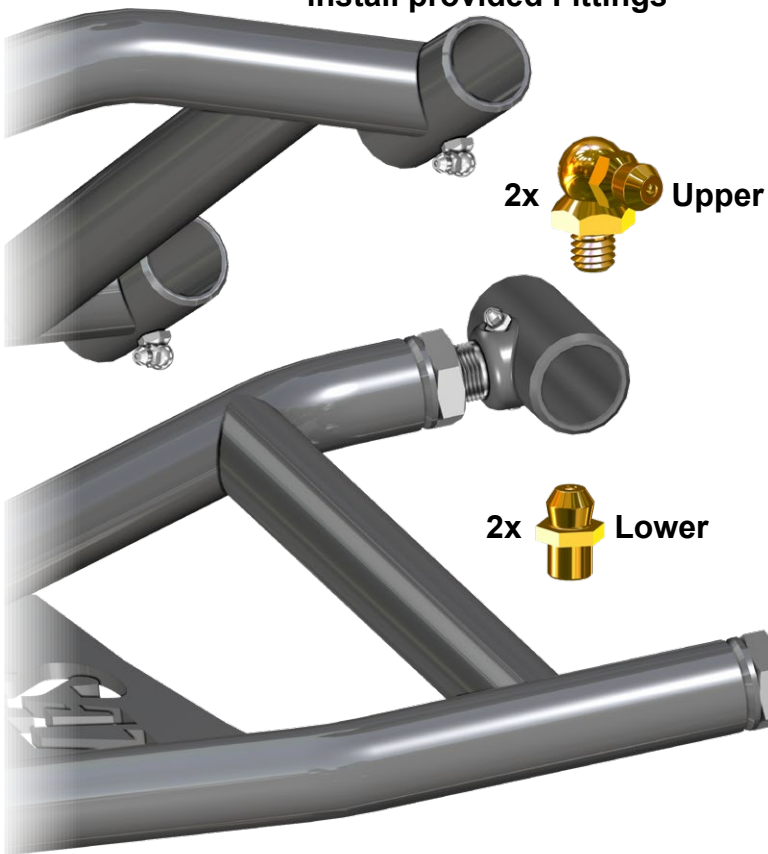

install stock Ball Joint into Uppers



Install provided SuperATV AAB-K-KRX A-Arm Bushing Kit

Pivot Block Settings

- Place new A-Arms onto a flat surface and verify dimension shown.
- *Negative 1° camber setting is achieved when Pivot Blocks are set to this dimension.*



*Leave Jam Nuts loose. Tighten after final adjustments have been made.

- Install Right and Left Shock Mounts (K)(L) (C) to stock Shock mounting locations on Frame with hardware shown; tighten completely.

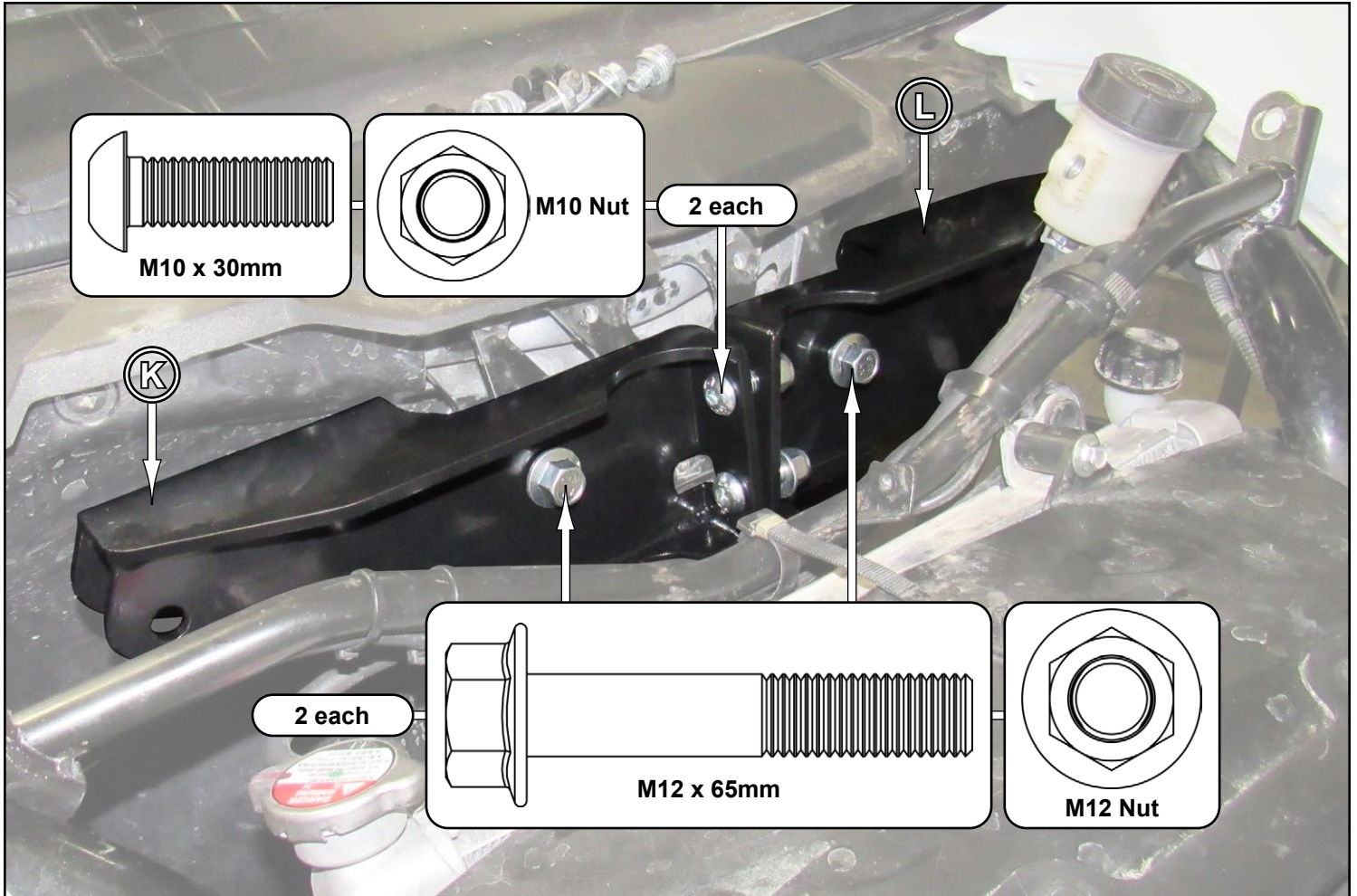

Radius Arms Settings

- Place Radius Arms onto a flat surface and verify dimension shown.

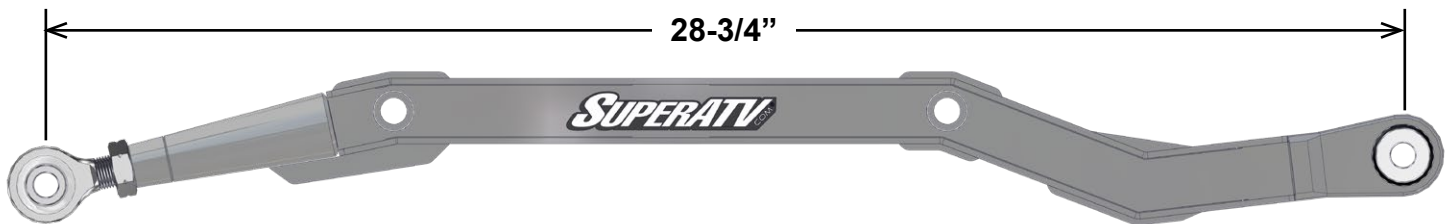
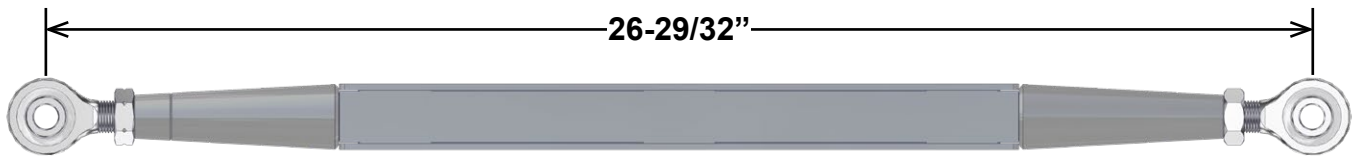

Steering Stop installation (Rack and Pinion shown off machine for clarity only)

- Install Steering Stop onto Shaft.
- Repeat steps for opposite side.

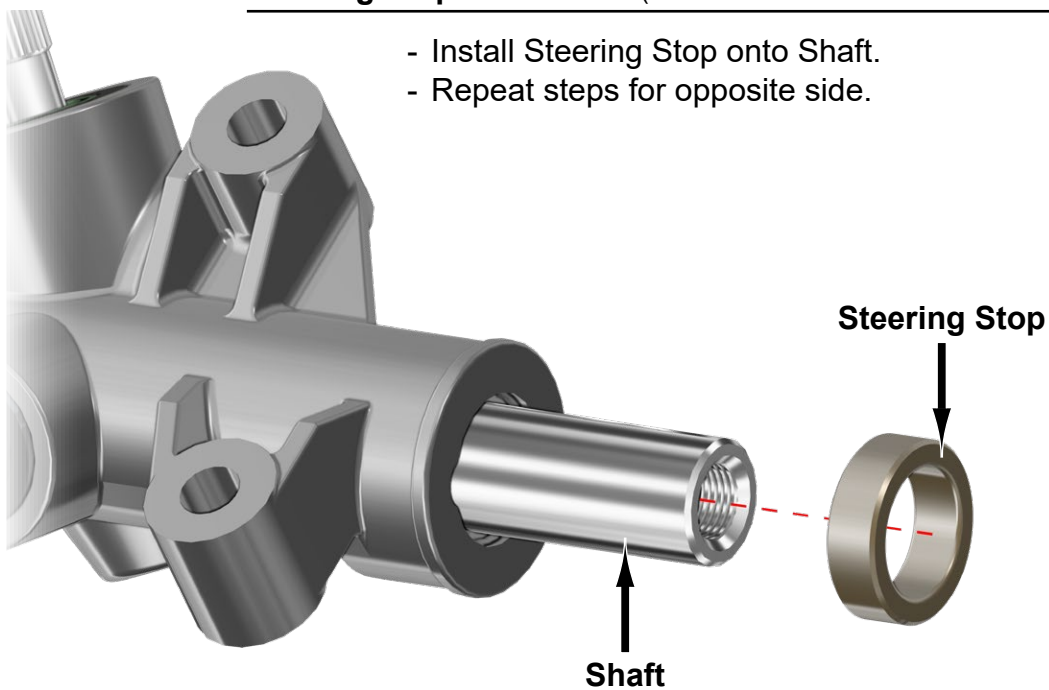

Tie Rods installation

- Remove Jam Nuts from Ball and Sockets.
- Install Ball and Sockets to Rack and Pinion. Use Loctite.
- Install Boots to Rack and Pinion and secure with Zip Ties. Use a lubricant to ease installation.
- Reinstall Jam Nuts to Ball and Sockets.
- Install Tie Rod Shafts to Ball and Sockets.
- Install Tie Rod Ends to Tie Rod Shafts.

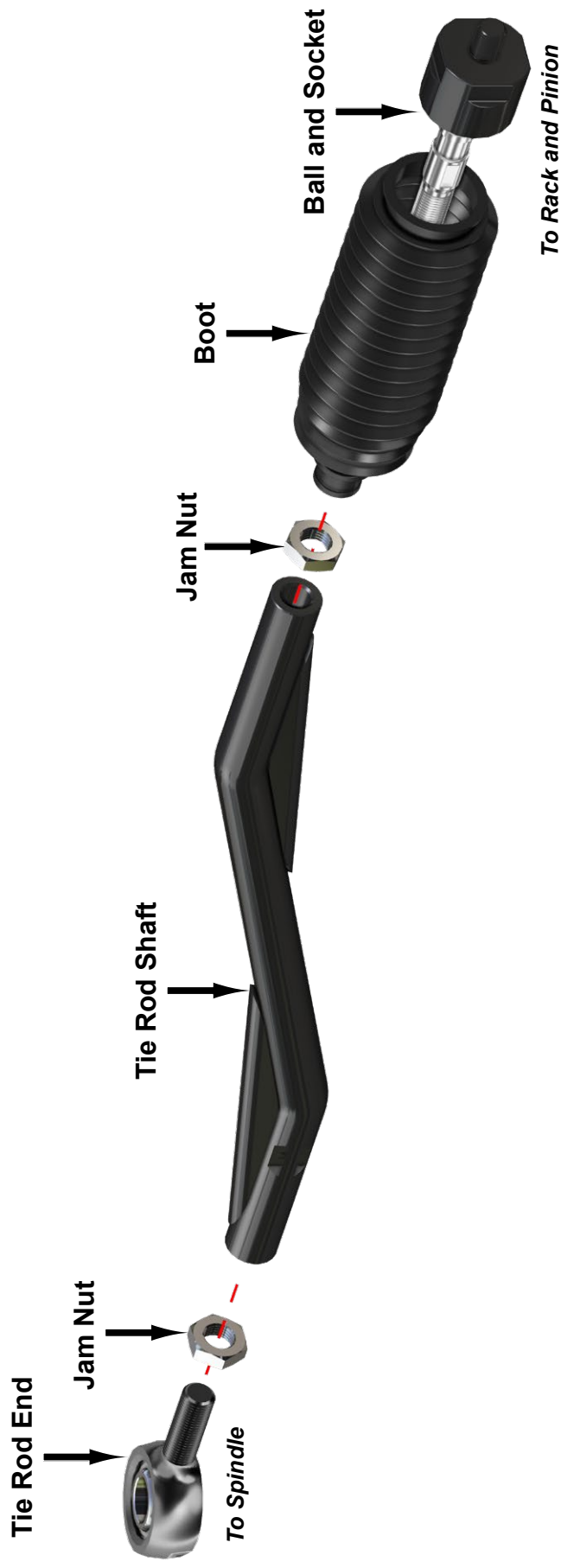

- Install Right Lower (C) to Frame with stock hardware. **Keep Nuts loose until all final adjustments have been completed.**
- Install new Front Axle.
- Install Right Upper (A) to Frame with stock hardware; tighten hardware completely. SuperATV recommends using Loc-Tite on Nuts.



- Install Knuckle to A-Arms with stock hardware. SuperATV recommends using Loc-Tite on Nuts.
- Secure Tie Rod End to Knuckle with hardware shown.

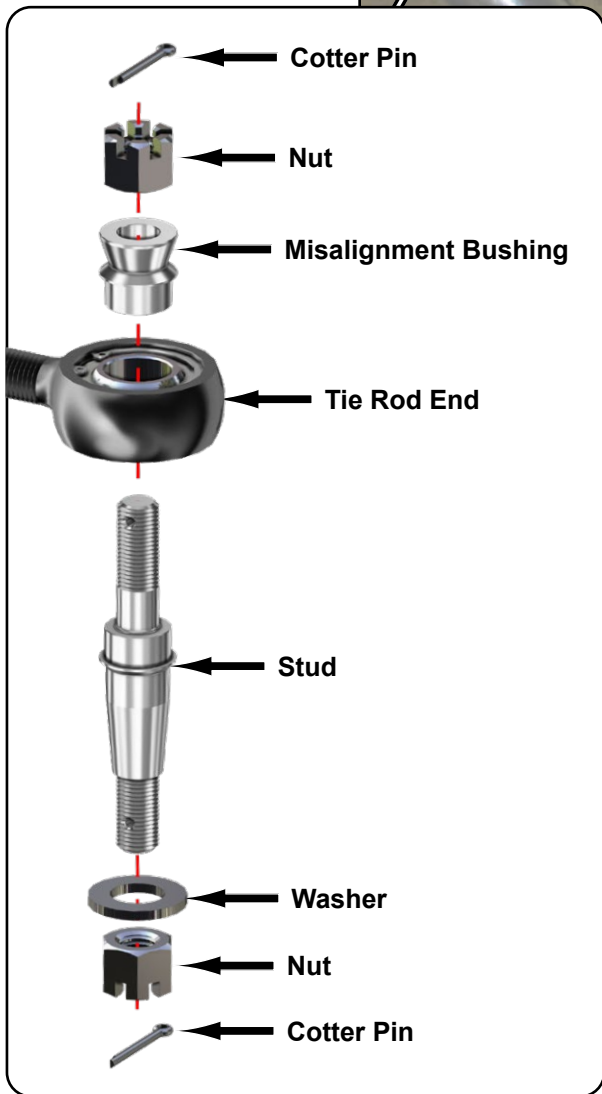
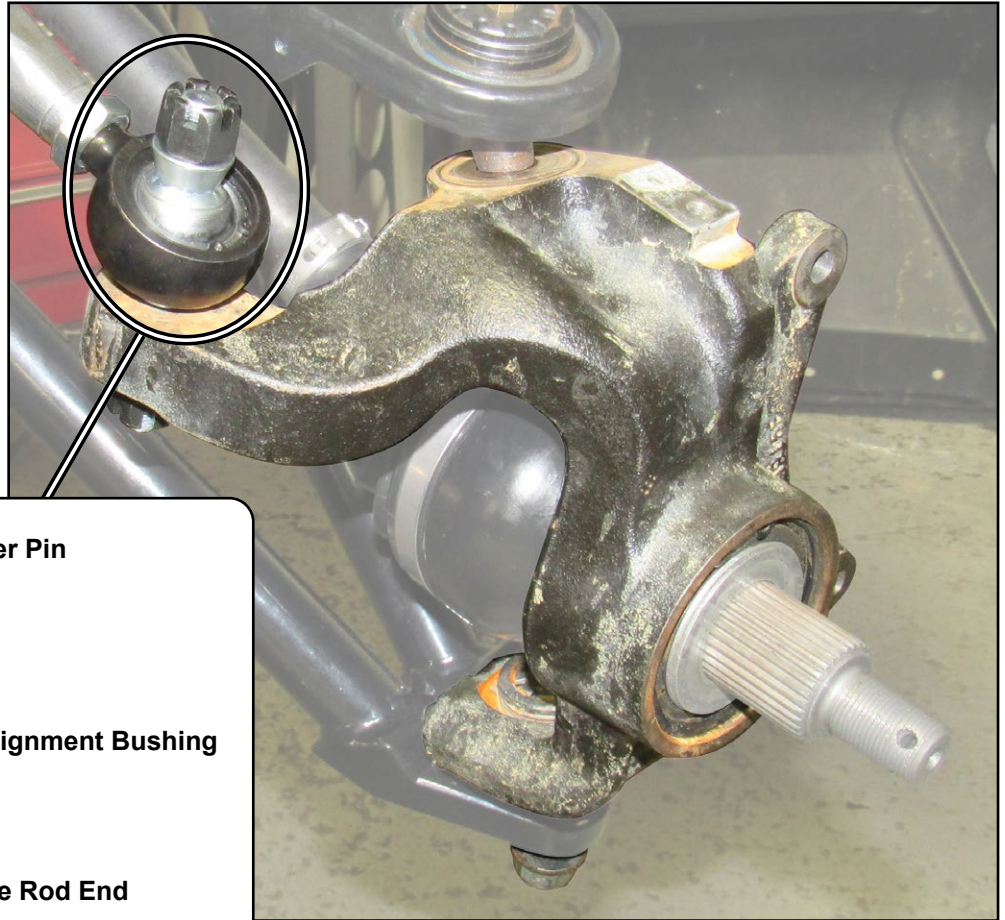

- Secure Shock to Right Shock Mount (K) with hardware shown.

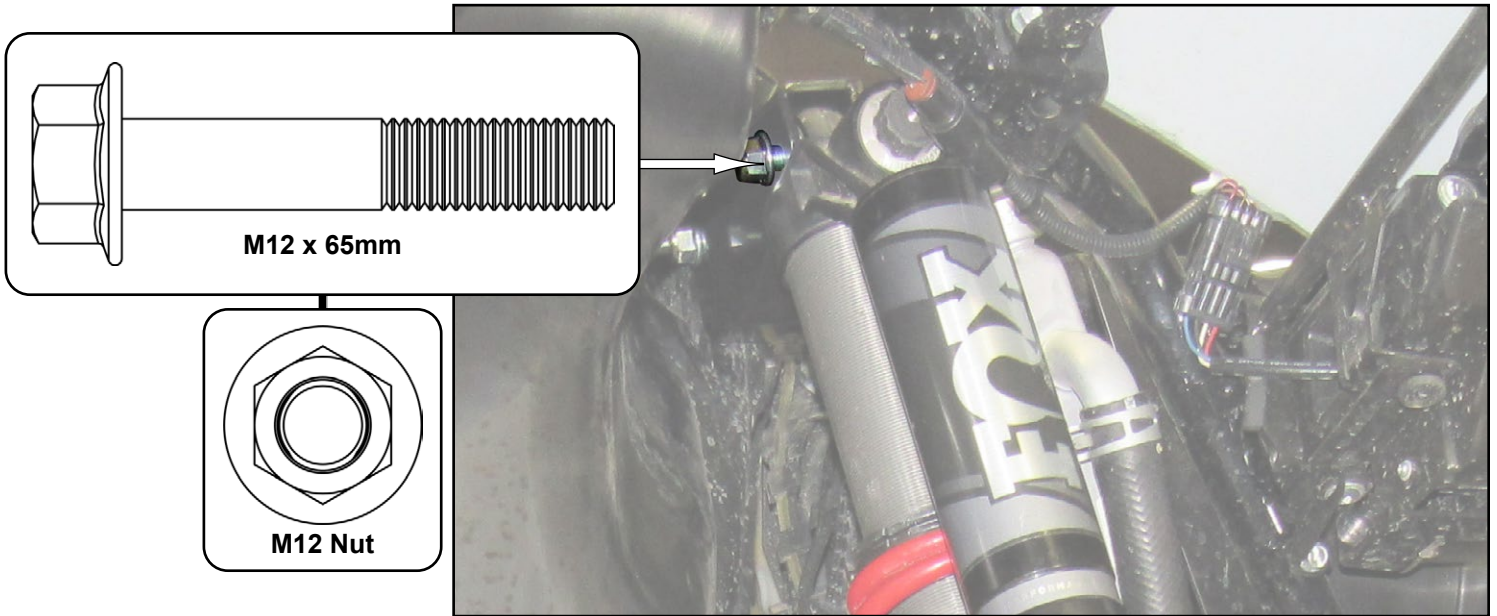

- Secure Shock to Right Upper (A) with hardware shown.
- Secure Swaybar Link to Right Upper (A) with stock hardware.
- Reinstall Rotor and secure Axle.
- Reinstall Caliper and install provided Brake Line.
- Secure Brake Line to Right Upper (A) with components shown.

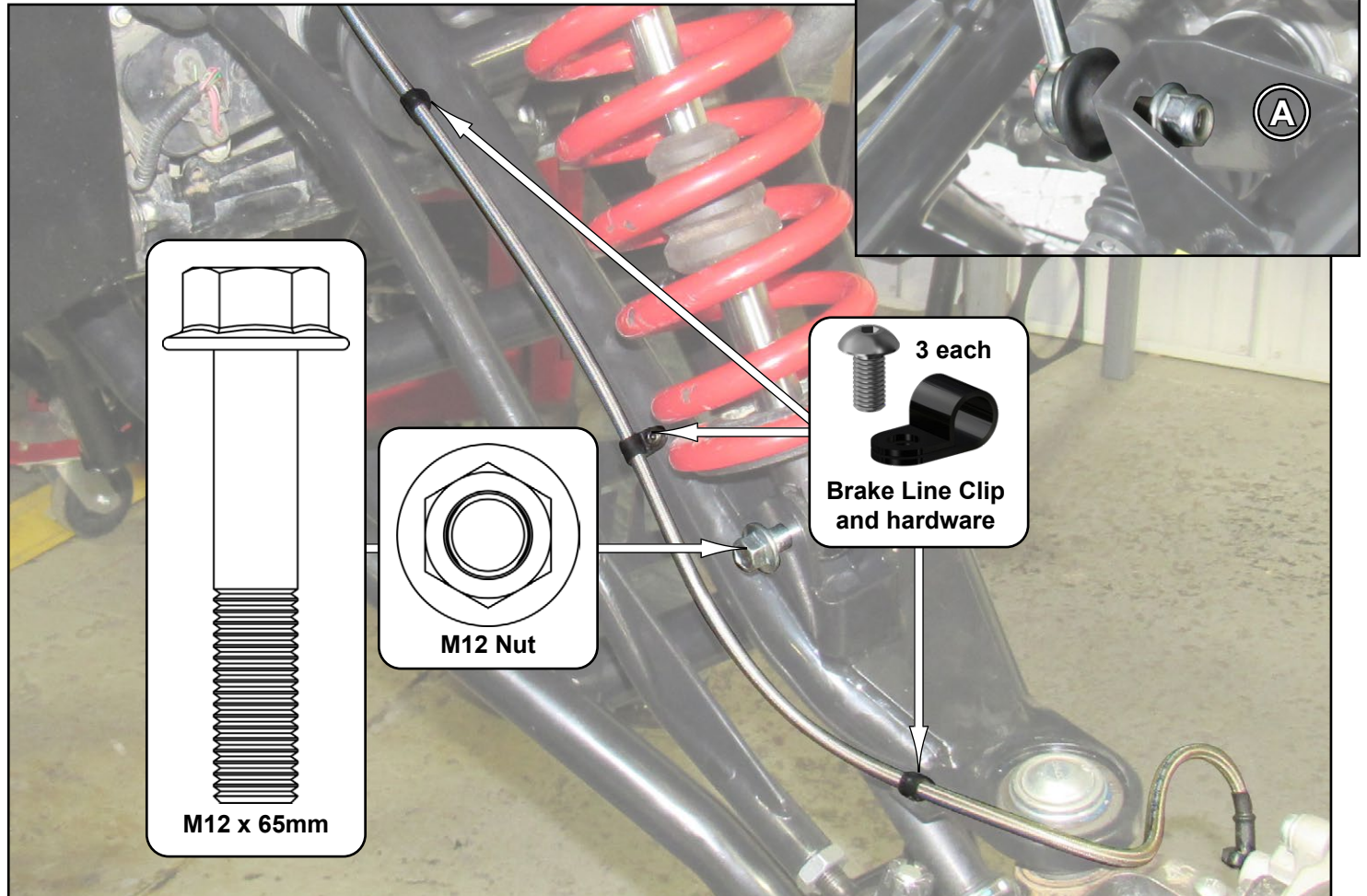

tighten hardware completely and repeat steps for opposite side

Rear Spacer installation

- Place Shock into Spring Compressor.
- Remove Retainer and Spring.

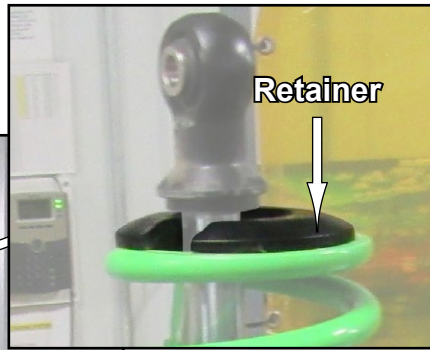

Rear Spacer installation continued

- Install Rear Spacer.
- Reinstall Spring and Retainer.



- Repeat steps for remaining Rear Shock.

- Place Inner Rear Shock Mount (M) *behind* location shown.

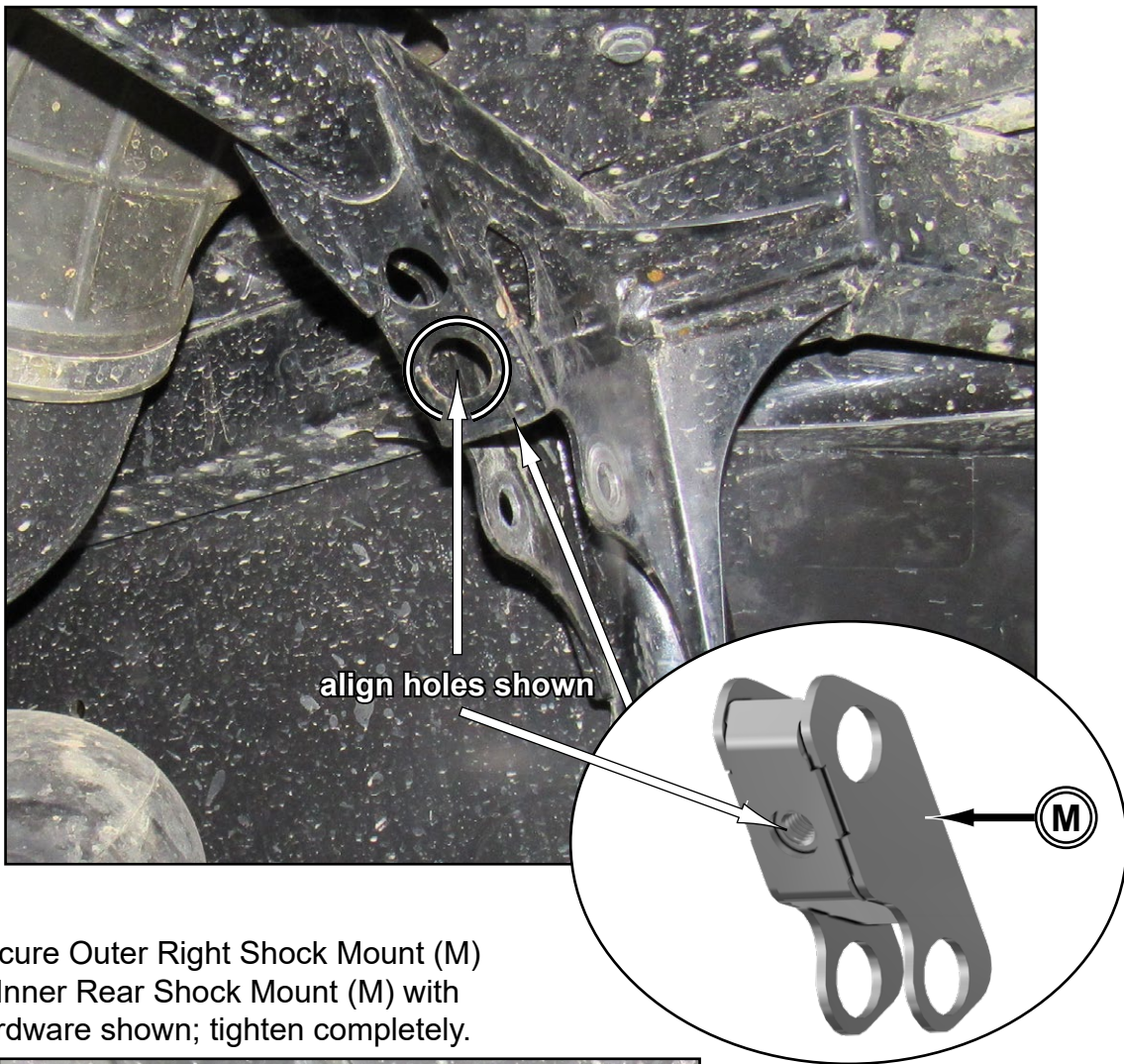

- Secure Outer Right Shock Mount (M) to Inner Rear Shock Mount (M) with hardware shown; tighten completely.

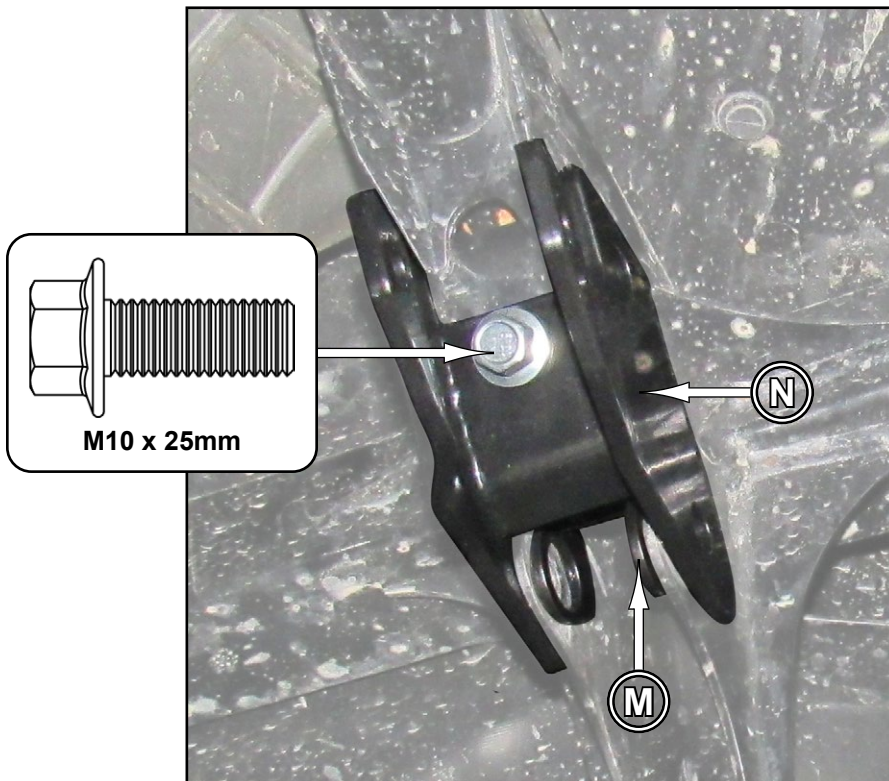

- Secure Mounts with hardware shown.

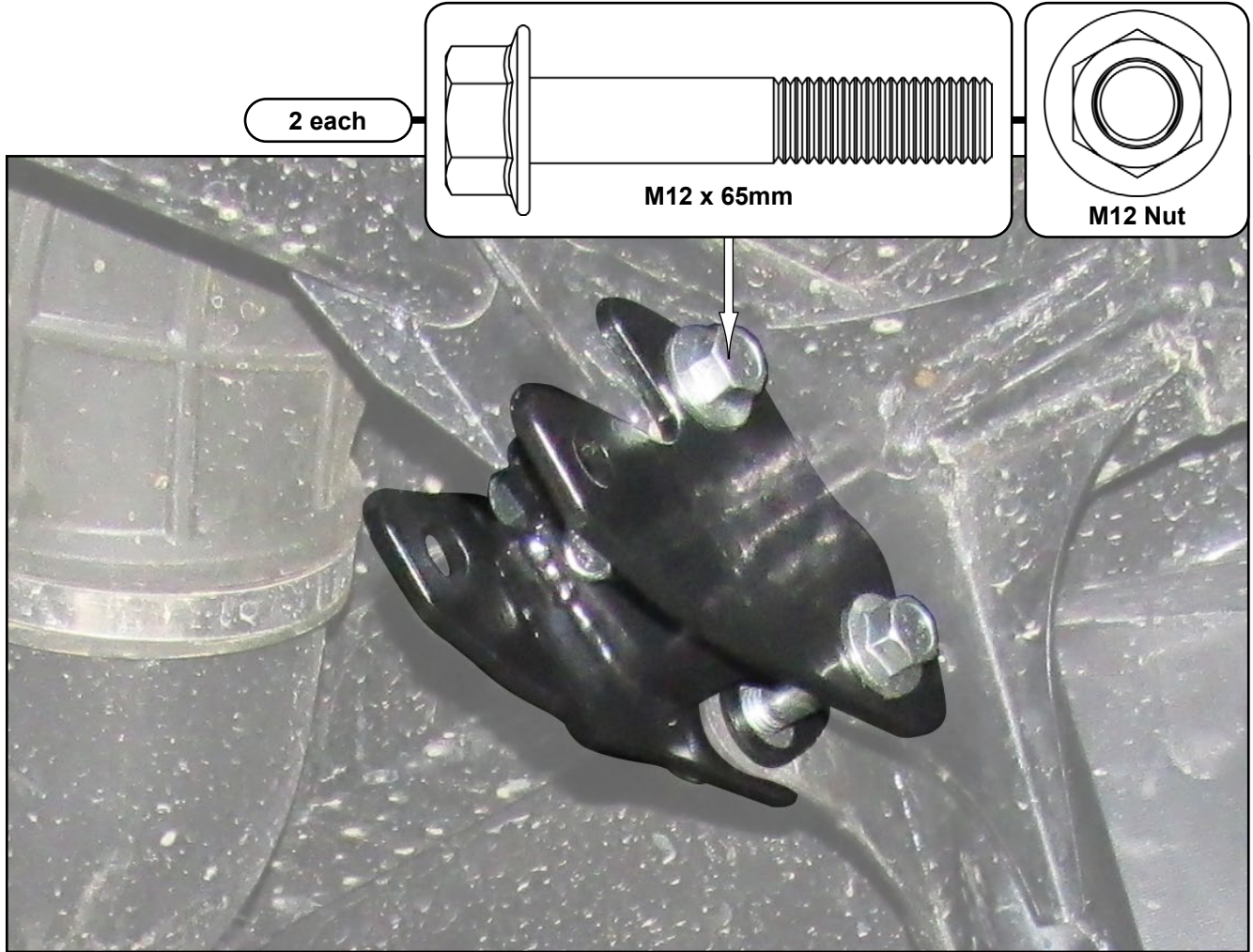

- Install Right Trailing Arm (E) to Frame with stock hardware.
- Secure Swaybar Link to Right Trailing Arm (E) with stock hardware.

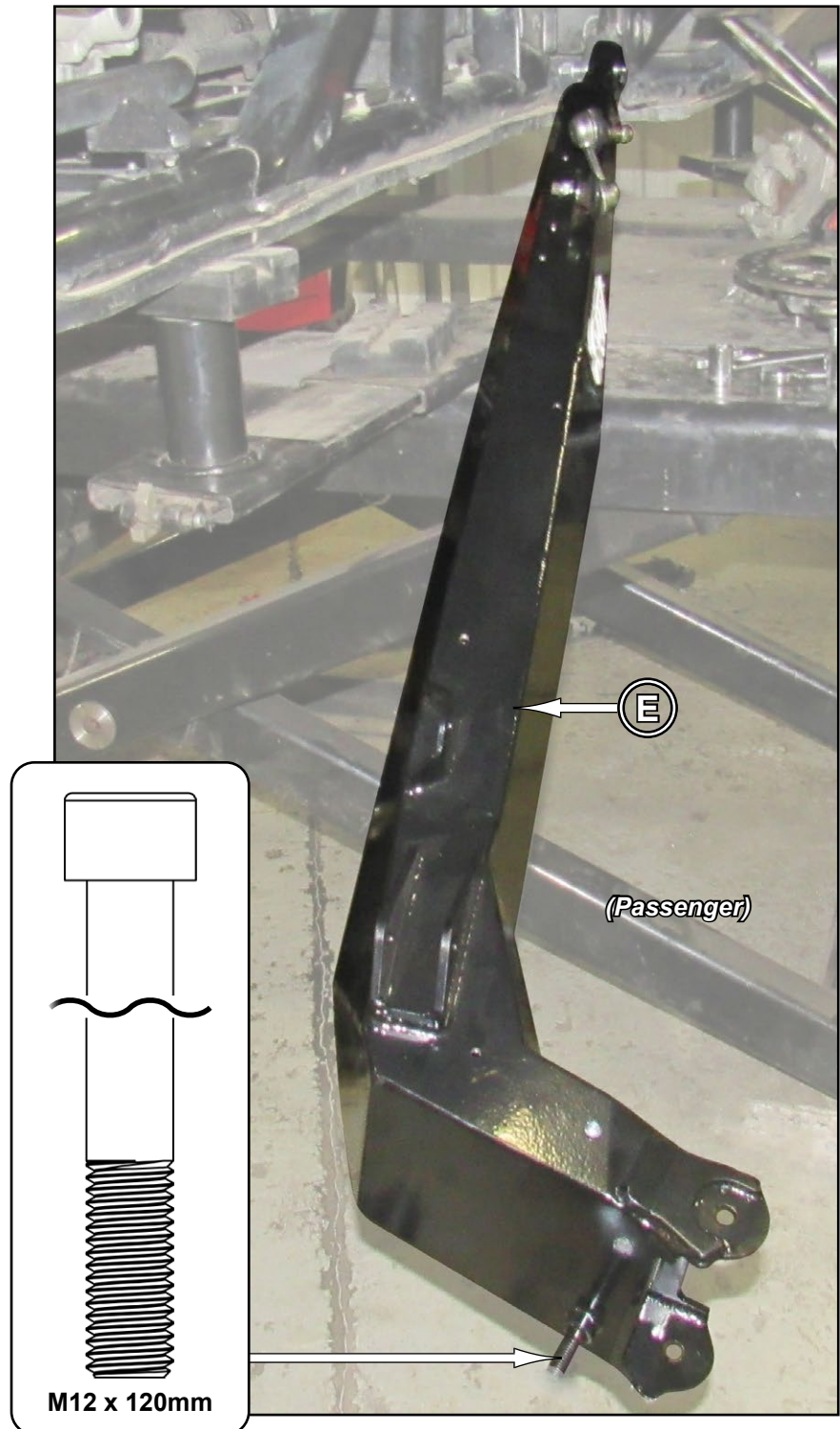

- Install hardware shown to Right Trailing Arm (E).

- Install Lower Inner RA (H) to Frame with stock hardware. Secure to previously installed hardware on Right Trailing Arm (E).

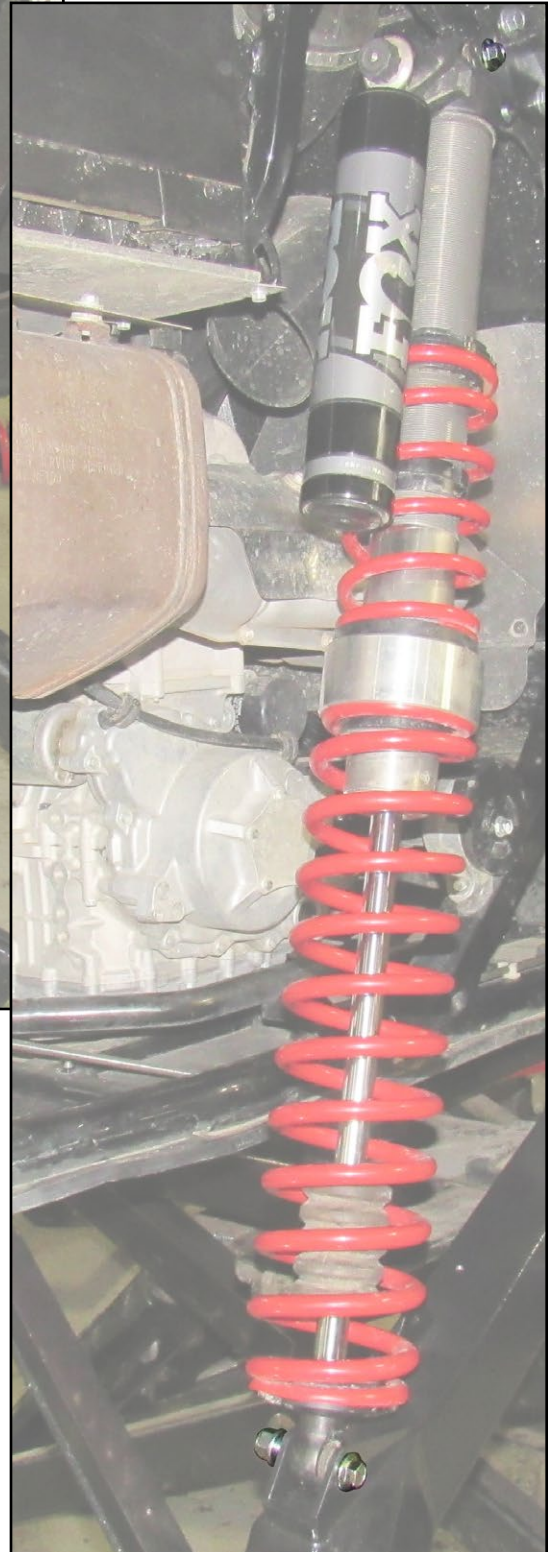

- Install new Rear Axle and Knuckle.
- Install Lower Outer RA (J) to Frame and Knuckle with stock hardware.

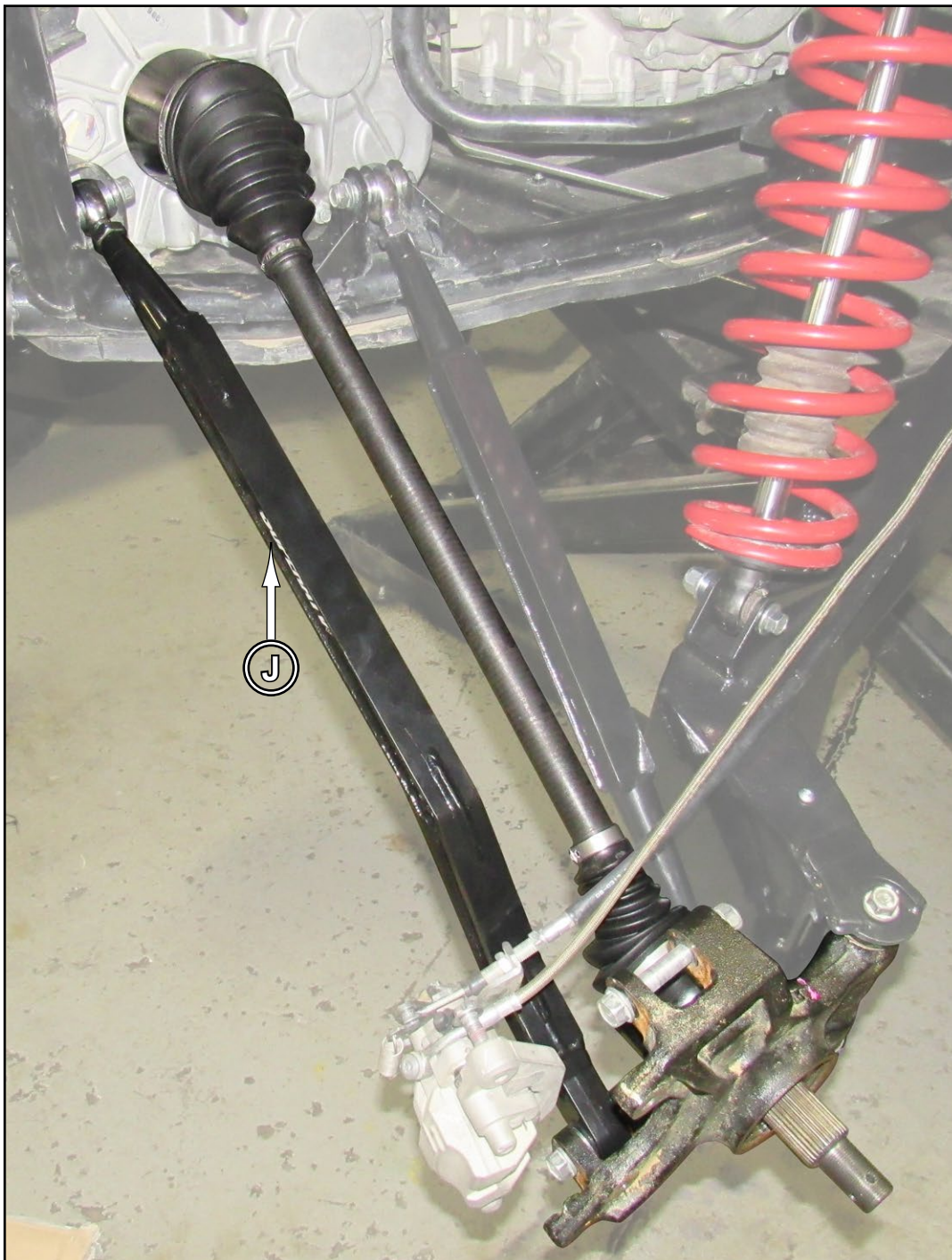

- Install Upper RA (G) to Frame and Knuckle with stock hardware.



- Secure Brake Lines and Swaybar Link with stock components.

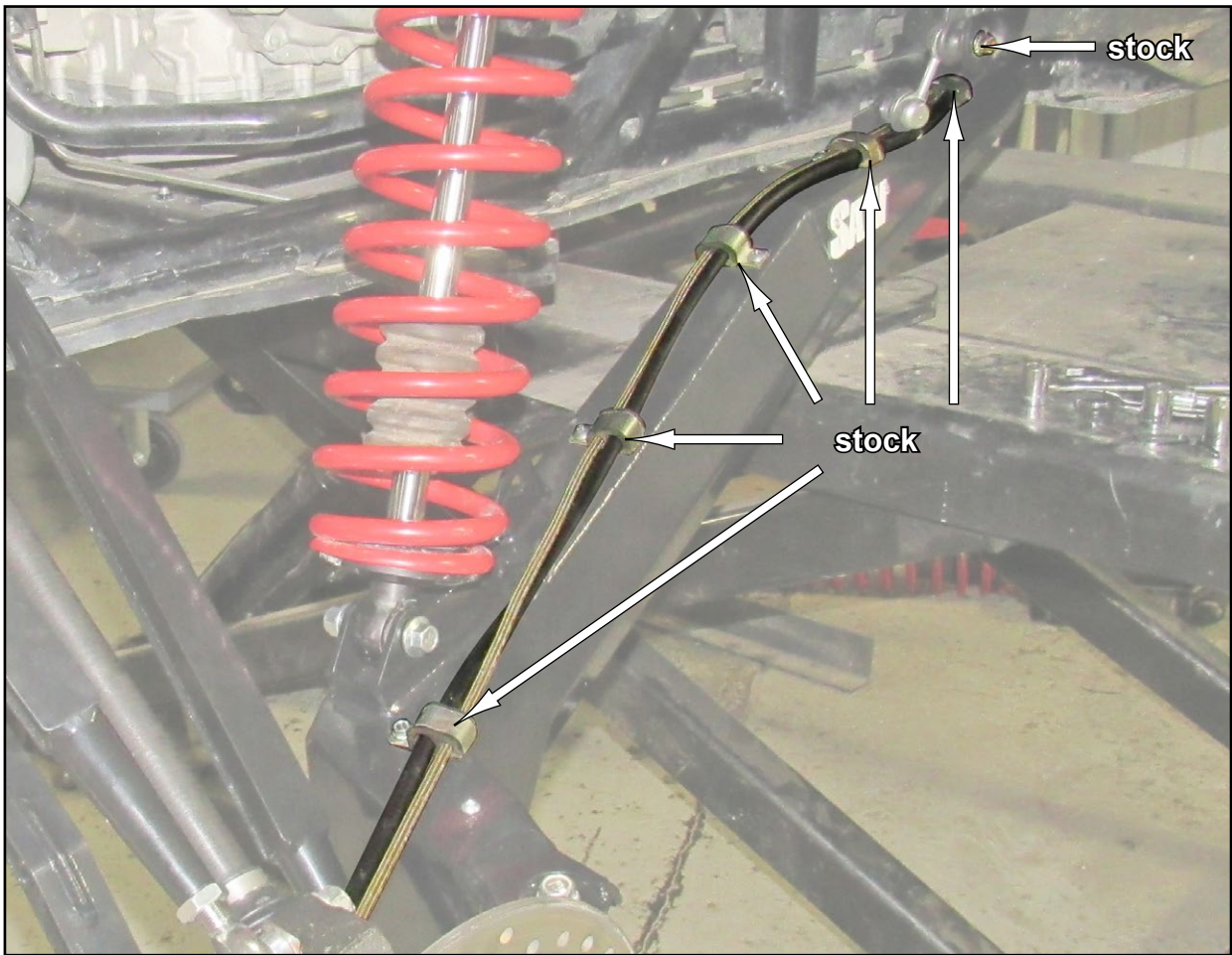

tighten all hardware completely and repeat steps for opposite side

- Reinstall Tires and see following page for Camber adjustments if required.
- Tighten previously installed Nuts, on Lower, completely. SuperATV recommends using Loc-Tite.

CAMBER

- Tires must have equal air pressure before making adjustments.
- Adjustments to be made after all suspension components have been completely assembled.
- Tires must not be in contact with ground when making adjustments.
- Perform adjustments in small increments.



Adjusting Camber:

- Remove A-Arms from Frame and turn Pivot Blocks to adjust camber. Reinstall Arms.
- Lower machine and settle suspension components by rolling machine back and forth several feet at a time.
- Check settings and make small adjustments as needed.
- Each time an adjustment is made, machine must be rolled back and forth to settle suspension components.
- Once desired setting is achieved, tighten hardware completely. Loc-tite on Nuts is recommended.

A NEGATIVE CAMBER SETTING OF 1° to 2° IS RECOMMENDED.

LOWER:

Too much positive camber: adjust Pivot Blocks **OUT**.

Too much negative camber: adjust Pivot Blocks **IN**.

note: 2 full turns is 1°

UPPER A-ARMS:

Too much positive camber: adjust Pivot Blocks **IN**.

Too much negative camber: adjust Pivot Blocks **OUT**.

note: 2 full turns is 1°

