

- Do not discard packaging until product has been successfully installed.

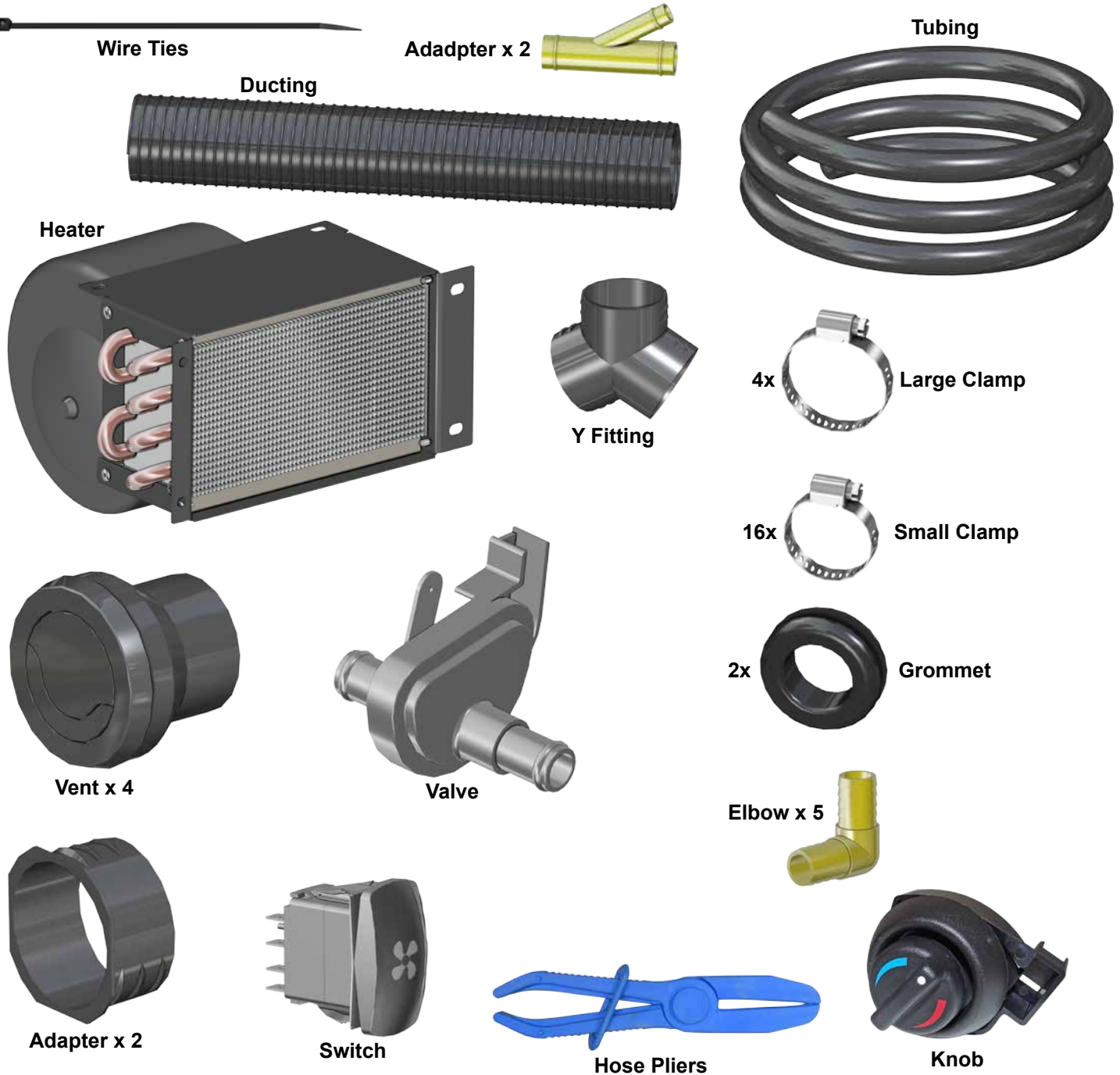

(kit contents continue on following page)

**Need help with your installation?**



sales@superatv.com



www.superatv.com



1-855-743-3427



8:00am - 8:00pm EST M-Th  
8:00am - 7:00pm EST Friday  
9:00am - 2:00pm EST Saturday

**Read instructions and view illustrations before beginning.**

*Thank You  
For Choosing*



(kit contents continued)

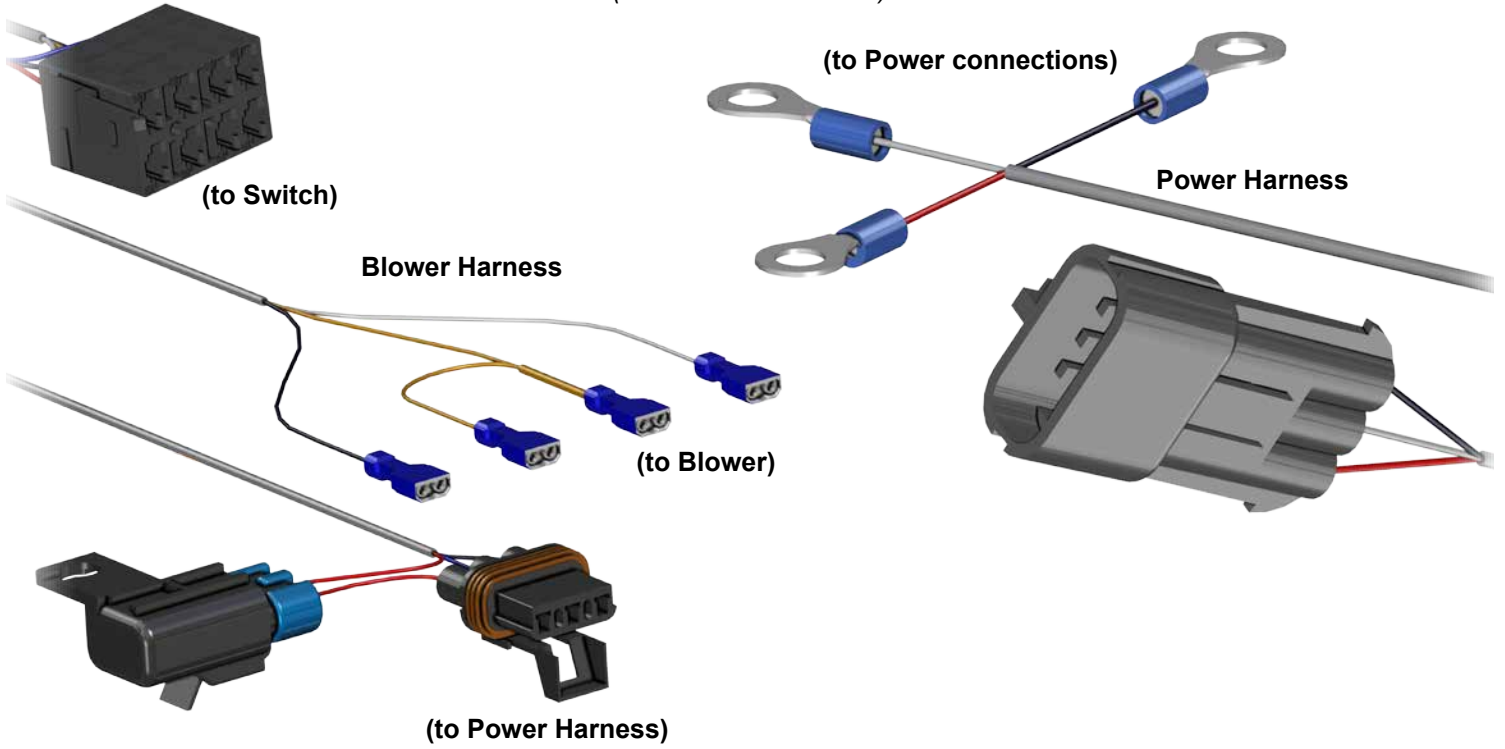

Bracket 1

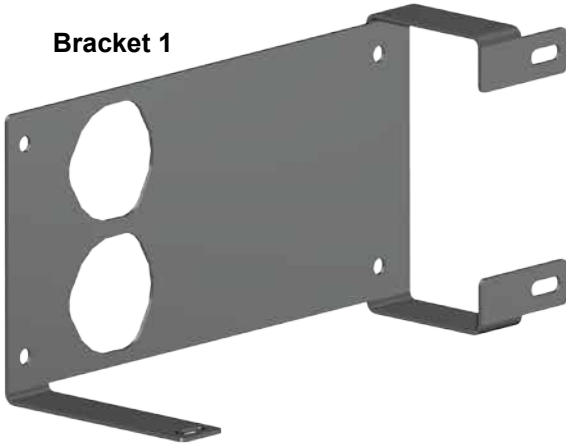

Bracket 2

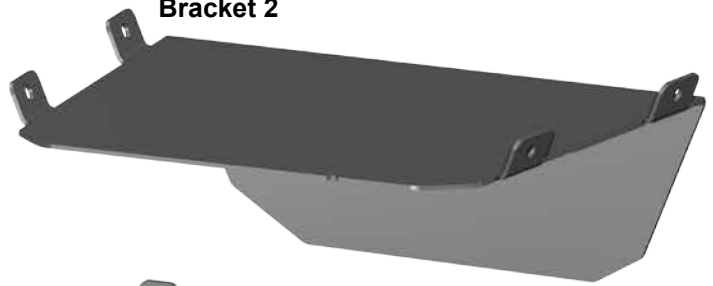

Bracket 4\*

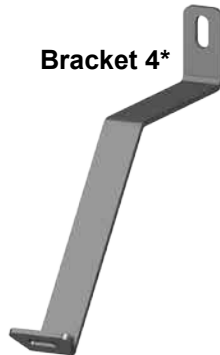

Bracket 5\*

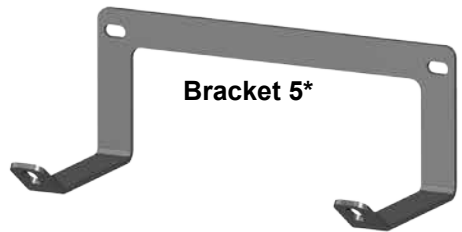

Bracket 3

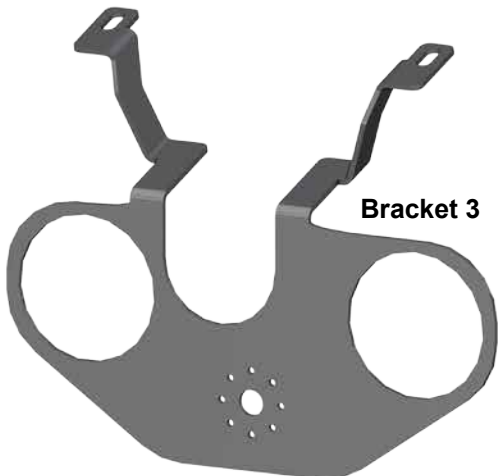

\*only used if machine is equipped with Smart-Lok

#### CUSTOMER NOTIFICATION AND DISCLAIMER LIABILITY

**This product is a modification for utility task vehicles and all terrain vehicles. Use this product at your own risk.**

**Warranty and Liability Limitations.** The Buyer hereby assumes all risks associated with the use and/or installation of this product. Buyer waives all liability claims against SuperATV® of any kind or nature, including, but not limited to, liability for penalties, fines, property damage, personal injury or death, to the fullest extent permitted by law. Buyer acknowledges and agrees that SuperATV® is not liable for any direct, indirect, incidental, consequential or special damages, including but not limited to, damage, loss of life, loss of property or equipment, loss of profits or revenue, injury, or claims from any individual or entity arising from the use of this product.

The warranty for this product, if any, may give you ("Buyer") specific legal rights, and Buyer may also have other rights which may vary from state to state. The installation of this product may void or otherwise adversely affect your factory warranty.

Consult your vehicle warranty before using this Product. Under no circumstances will SuperATV® be liable for the voidance of the Buyer's vehicle warranty. Buyer assumes all risk and responsibility if a manufacturer and/or dealer voids the Buyer's vehicle warranty due to use of this Product.

**Safety and Laws.** Operate your vehicle at all times in a safe manner. You must abide by all local, state, and federal laws, including but not limited to vehicle safety, traffic laws, and ordinances. It is your responsibility to know the laws and how they apply to you. The installation of this product may violate certain local, state, and federal laws. Be advised that laws vary depending on town, city, county, state, etc. Use of this product on public streets, roads, or highways may be in violation law. The Buyer is solely and exclusively legally and personally responsible for any violation of the law by the installation or use of this product. In no case will SuperATV® be held liable if Buyer violates the law or uses the product in an unsafe manner.

The Buyer is responsible to fully understand the capability and limitations of his/her vehicle according to manufacturer specifications, warnings and instructions and agrees to hold SuperATV® harmless from any damage resulting from failure to adhere to such specifications, warnings and/ or instructions. The Buyer is also responsible to obey all applicable federal, state, and local laws when operating his/her vehicle while using this product, and the Buyer agrees to hold SuperATV® harmless from any violation thereof.

**Installation.** The installation of this product on your vehicle indicates that you have had the opportunity to inquire about applicable local, state, and federal laws and ordinances and that you have read and understand, and accept all of the terms of, this Disclaimer.

SuperATV® shall not be responsible for the proper installation, use, and service of this product. Rather, the Buyer shall be solely responsible for the installation of the product and any damage that may be done to the vehicle or vehicle components as a result of modifications made by the Buyer.

- ***Tubeing and Duct lengths are SuperATV recommended. User may install components in other locations. Verify lengths before final installation.***
  - ***Check behind areas being drilled for interference.***
  - ***Avoid burns and scalding by working on cool vehicles.***
  - ***Secure components away from rotating objects.***
  - ***Do not tighten mounting hardware until all components are in place.***
  - ***Use manufacturers recommended coolant.***
  - ***Avoid sharp bends when installing Tubeing.***
  - ***Verify that no leaks are present after installation.***
- 
- 

- Remove Glovebox.
- Reinstall after In-Dash Heater has been installed.

***this page intentionally blank***

- Follow profile and cut out Template.

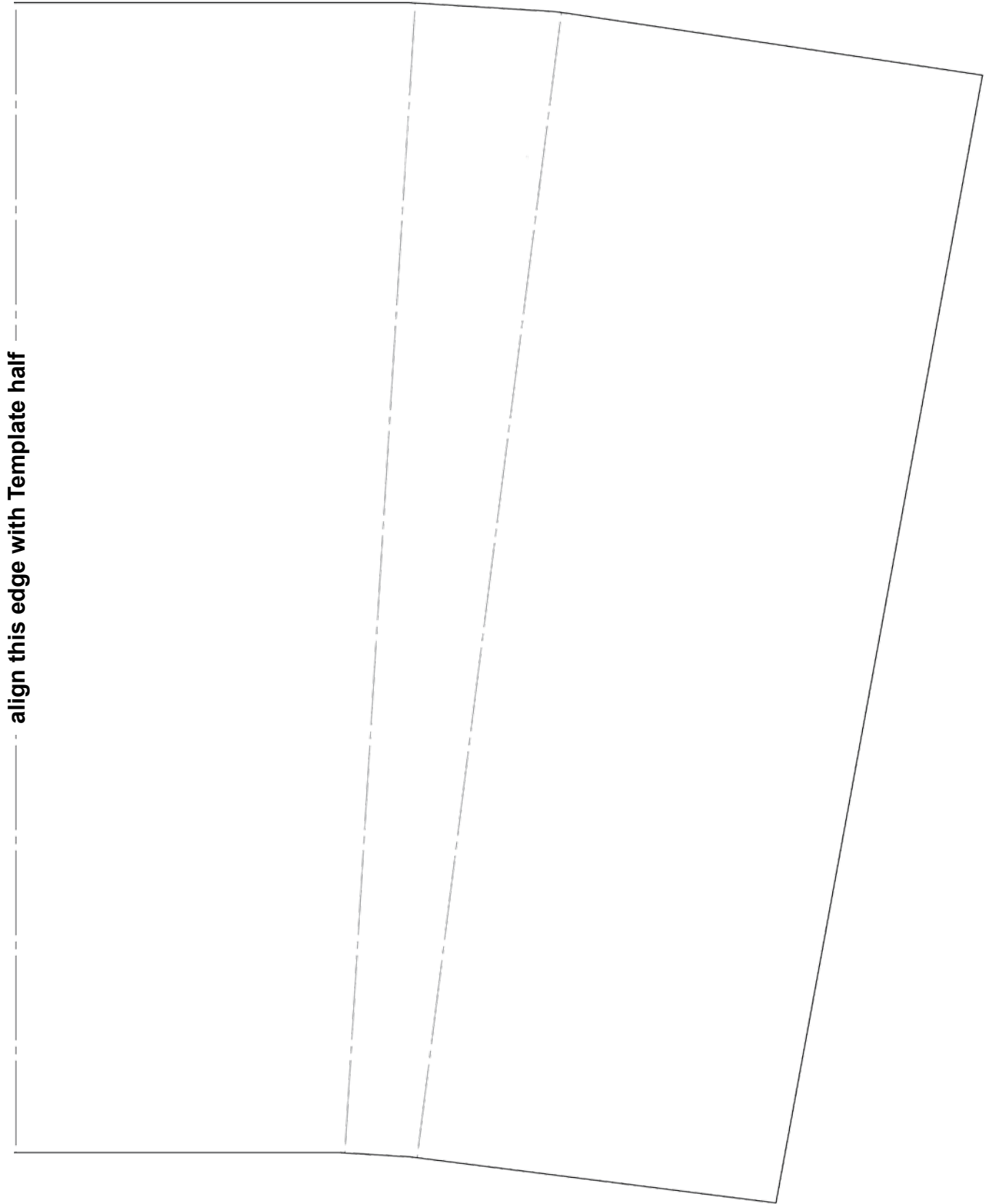

***this page intentionally blank***

- Follow profile and cut out Template.



- Tape Template pieces together and set aside.

***this page intentionally blank***



- Place Bracket 2 onto Glovebox.
- Mark top of Bracket 2 location onto Glovebox.



- Mark mid-point of new mark onto Glovebox.



- Tape Template onto Glovebox.

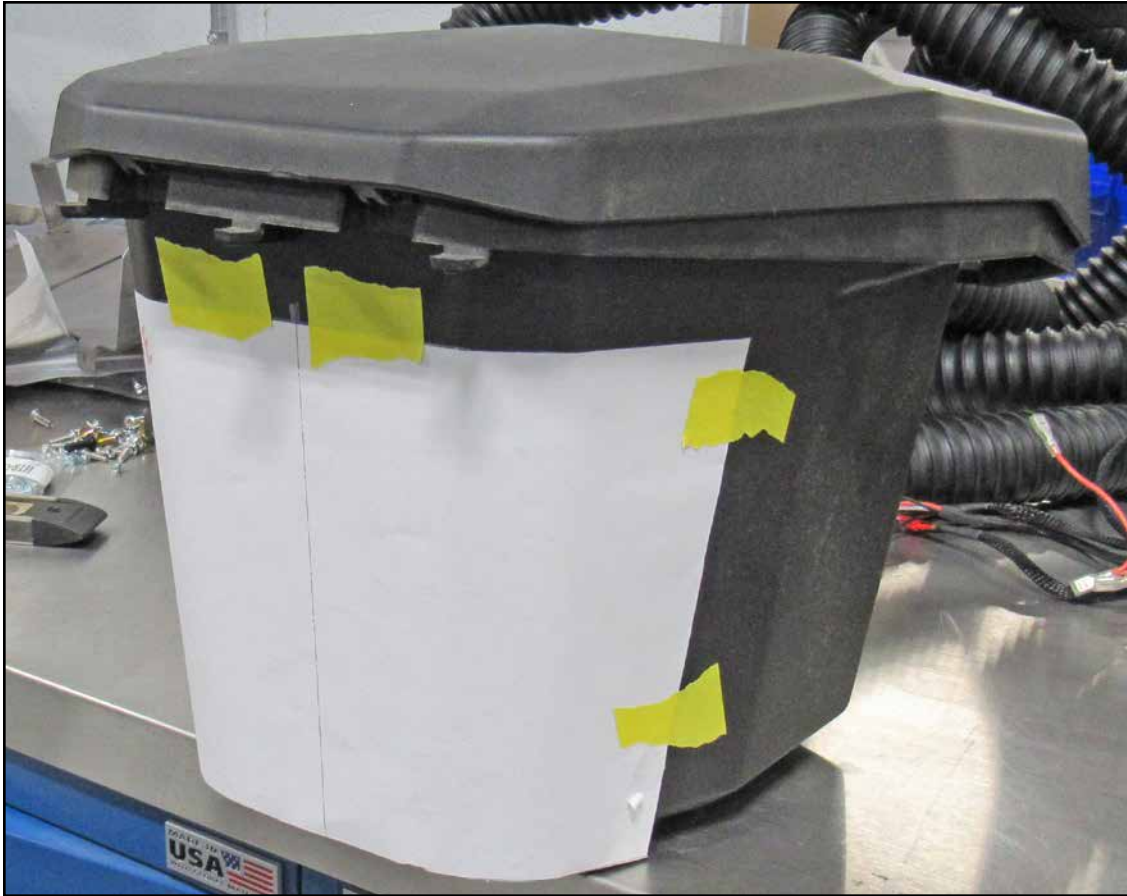

- Mark Template profile onto Glovebox.



- Follow profile and cut out material.



- Place Bracket 2 into new cutout.
- Mark hole locations onto Glovebox and drill through plastic. Holes to be large enough for Ø6mm bolts.
- Secure with hardware shown; tighten.

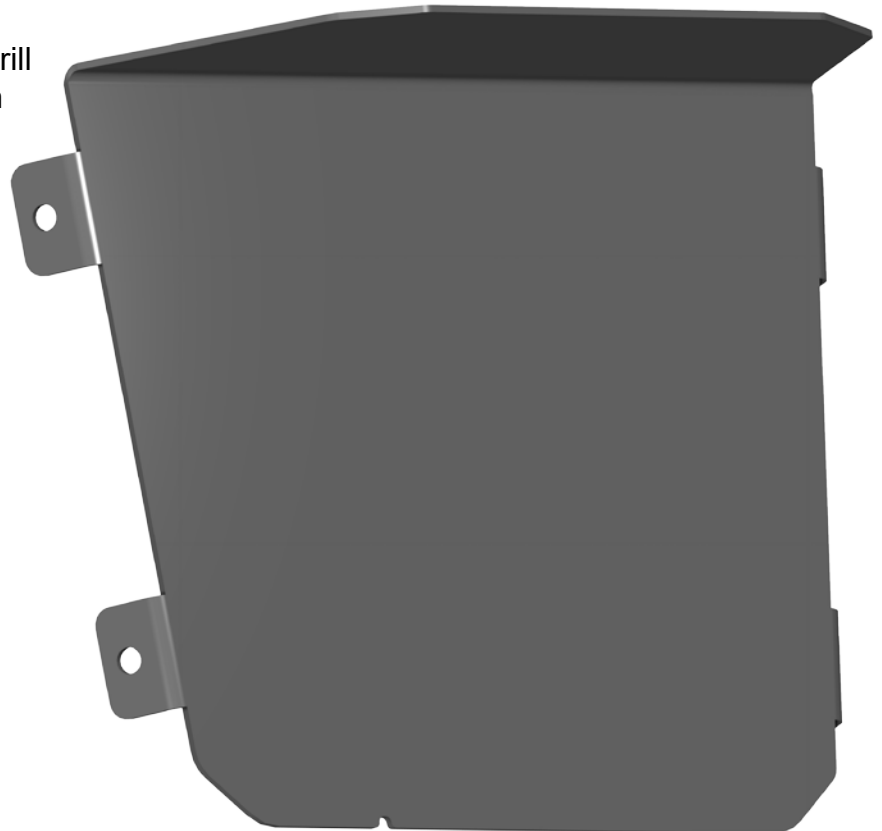
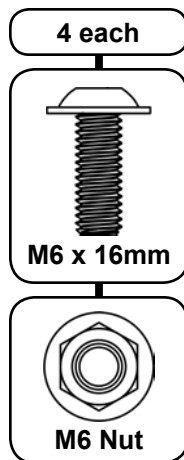



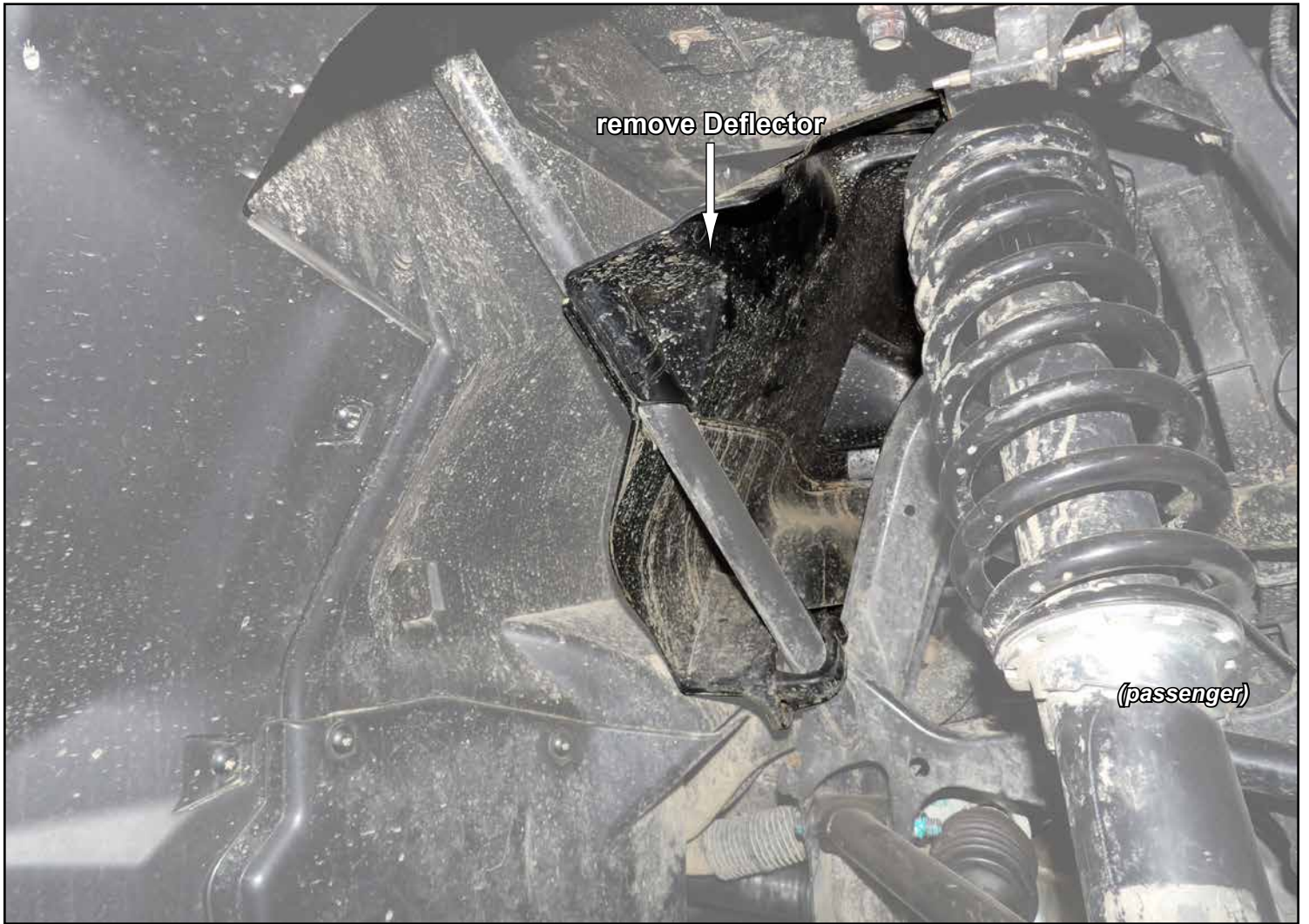

- Cut Tubing to approximate lengths shown.
- Assemble Outlet and Inlet Tubing assemblies using components shown.
- Tighten Small Clamps.
- Set assemblies aside.

630mm

Outlet Tubing assembly



345mm



120mm

540mm

Inlet Tubing assembly

300mm

60mm



60mm

60mm

Valve

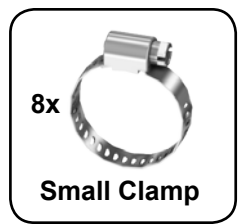



- Place Grommets in general area shown.
- Mark center points of Grommets and cut (2) Ø1-1/4" holes through Firewall.



- Insert Tubing assemblies into Grommets in locations shown.





*Bracket 3 shown installed for clarity only. Do not secure at this time*

- Place Bracket 3 into position shown and mark mounting holes onto Frame.
- Use a  $\text{Ø}7/32$ " drill bit to create pilot holes.

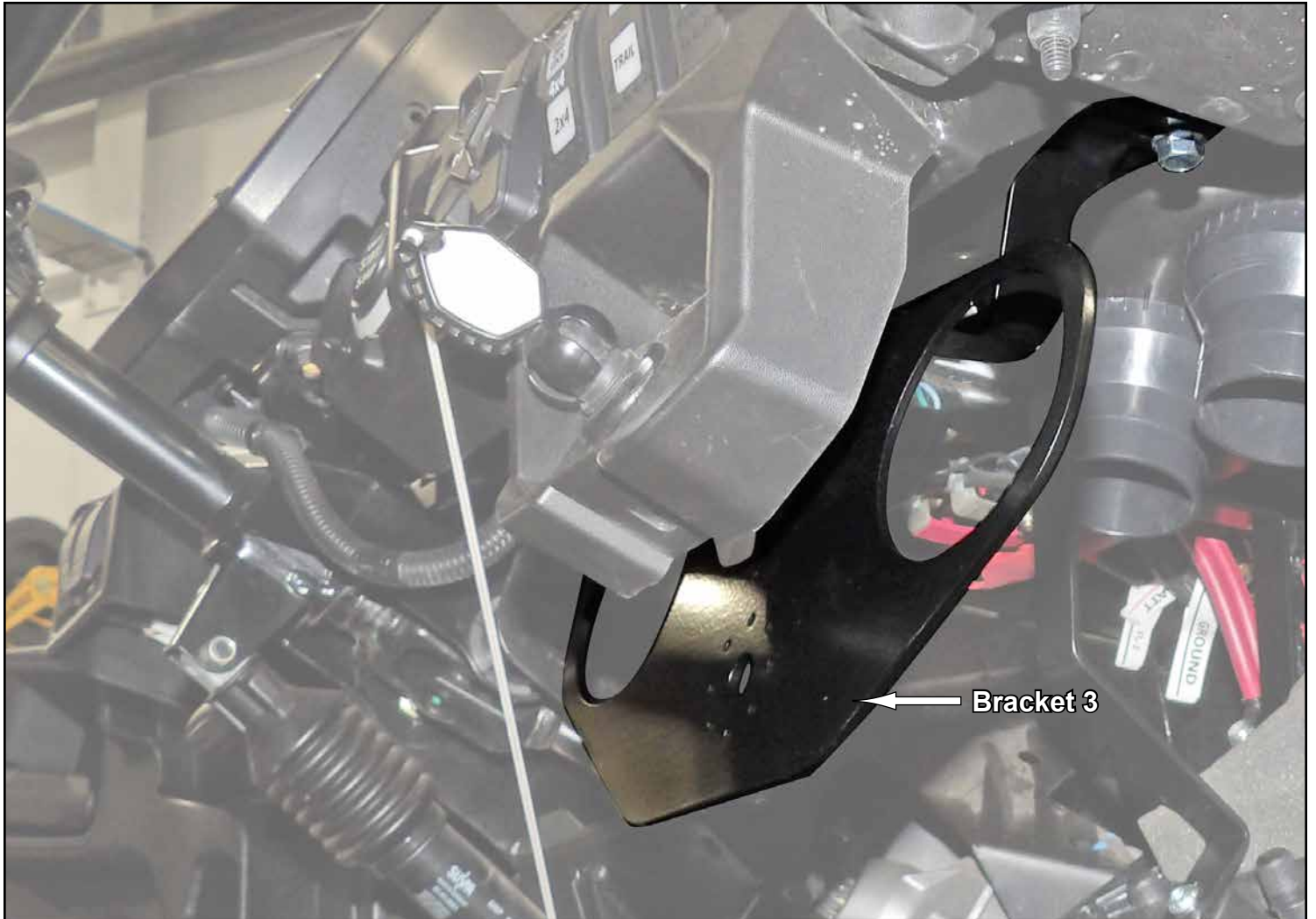



- Separate Vents and install to Bracket 3; tighten.



- Separate Knob and install to Dash; tighten.

- Connect Cable, from Valve, to Knob.

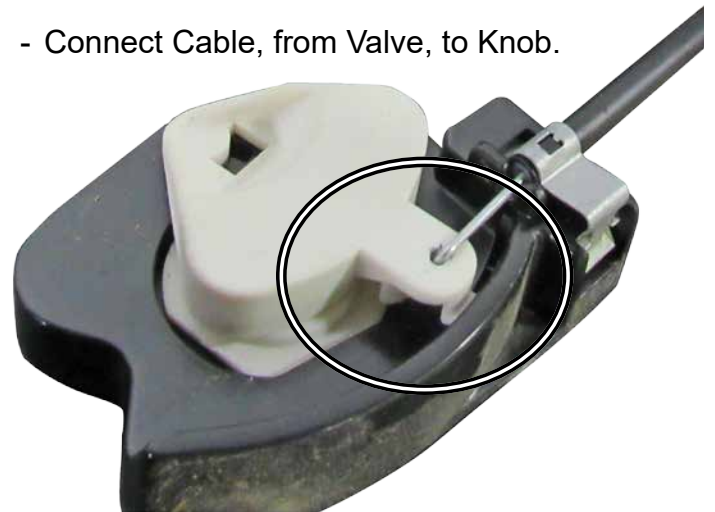

- Connect Blower Harness to Blower.

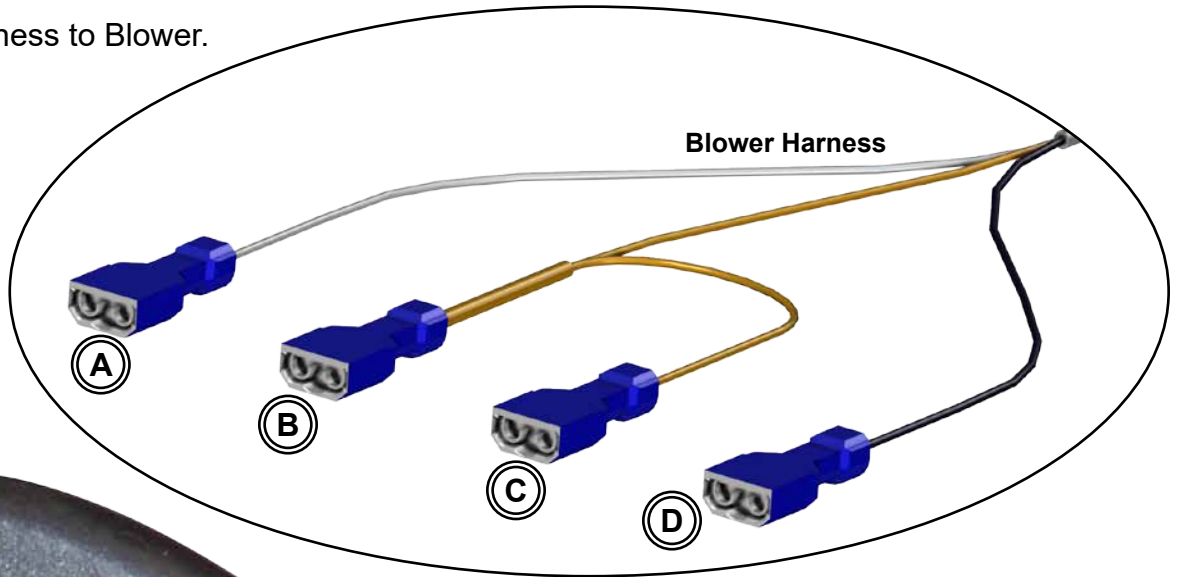



- Separate and place Vent Bottoms onto Dash in general areas shown below.
- Mark locations for Vents.
- Cut (2) Ø2-1/2" holes through plastic.



- Install Vents.





- Connect Power Harness to Terminal.



- Connect Blower Harness and install Switch.

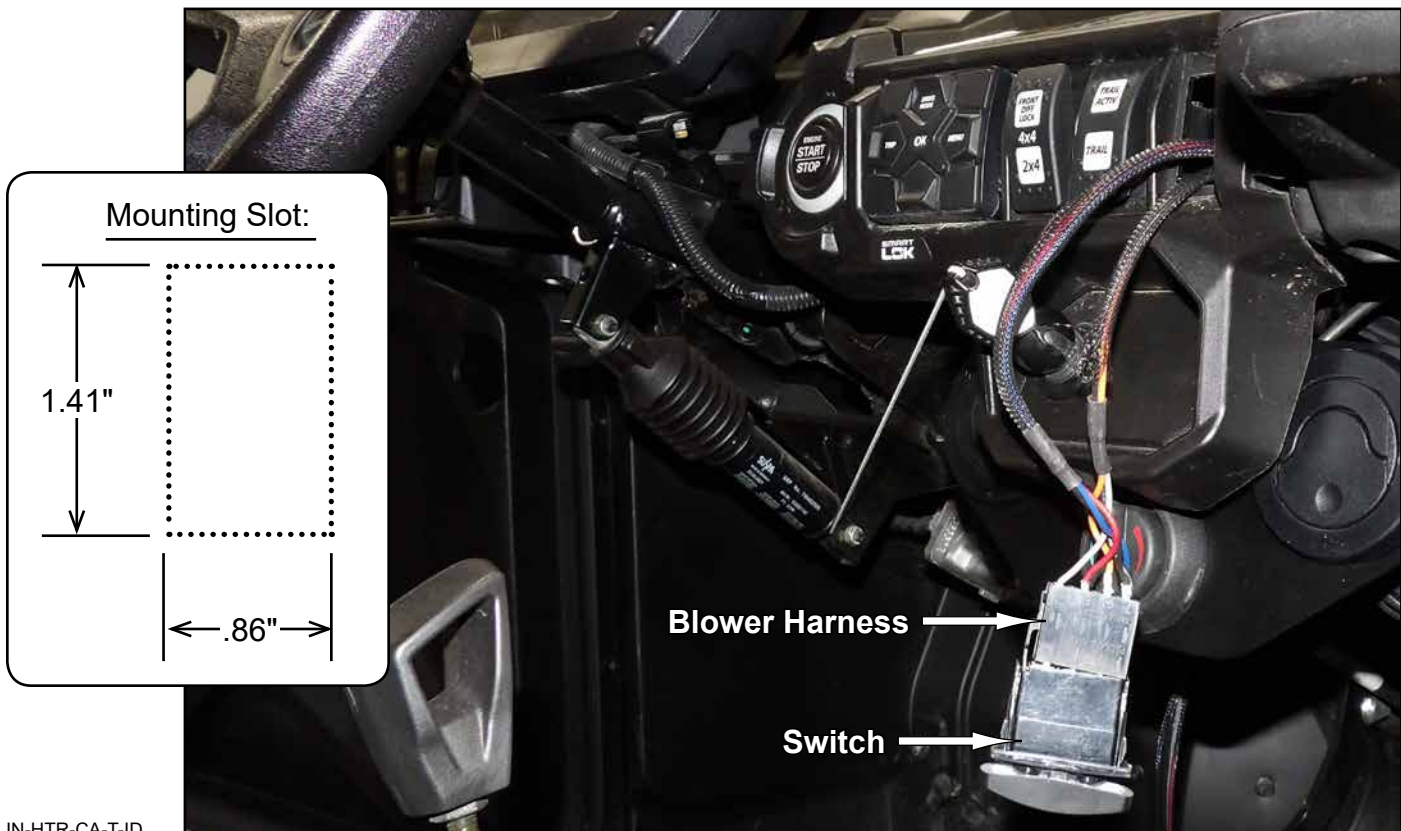

## Ducting assemblies

- Cut Ducting to lengths shown and connect to Y-Fittings.
- Secure with Wire Ties.
- Set aside.

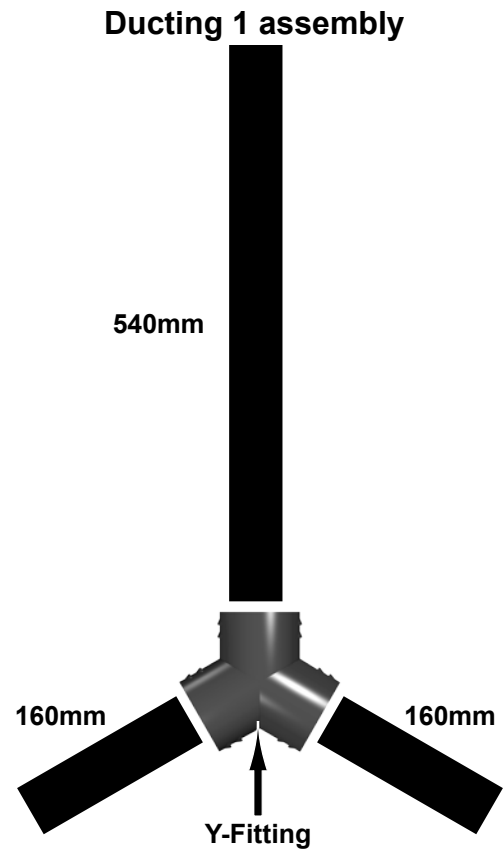
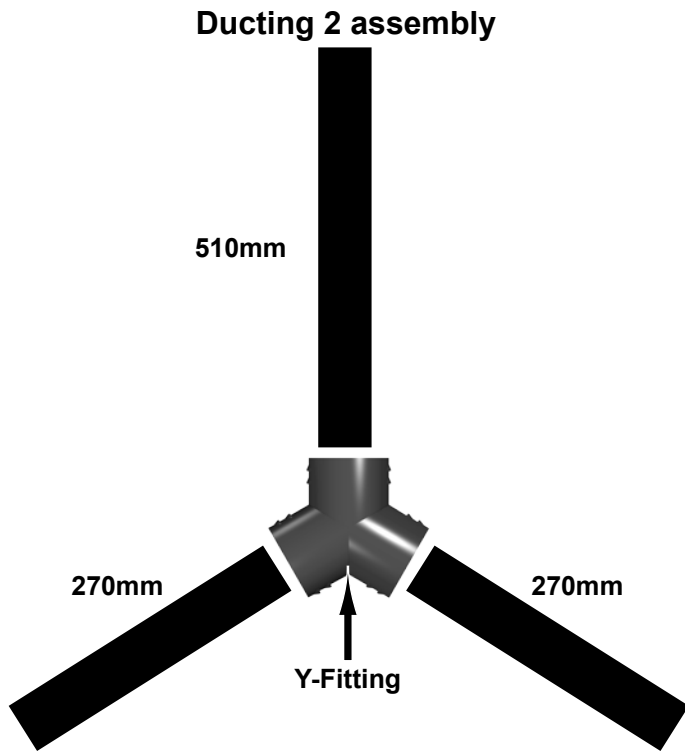

- Install Adapters to Bracket 1.

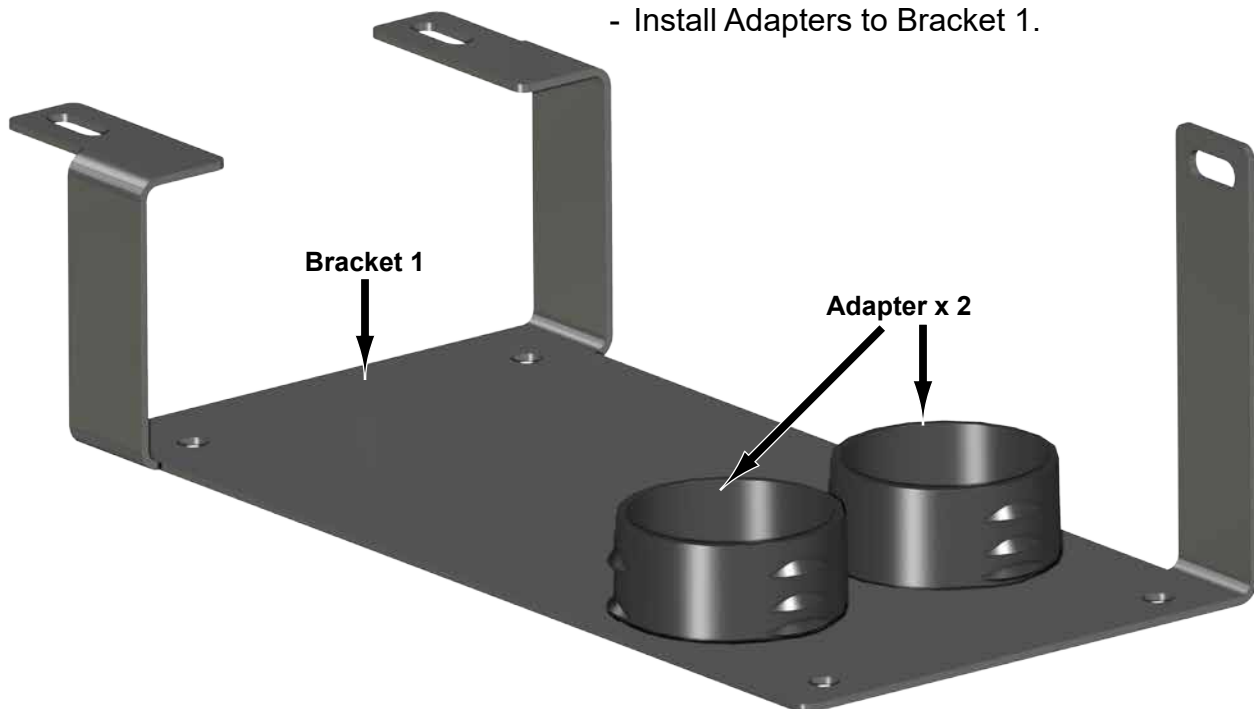

Place Bracket 1 into position shown and mark mounting holes onto Frame.





- Secure Bracket 1 to Heater with hardware shown.

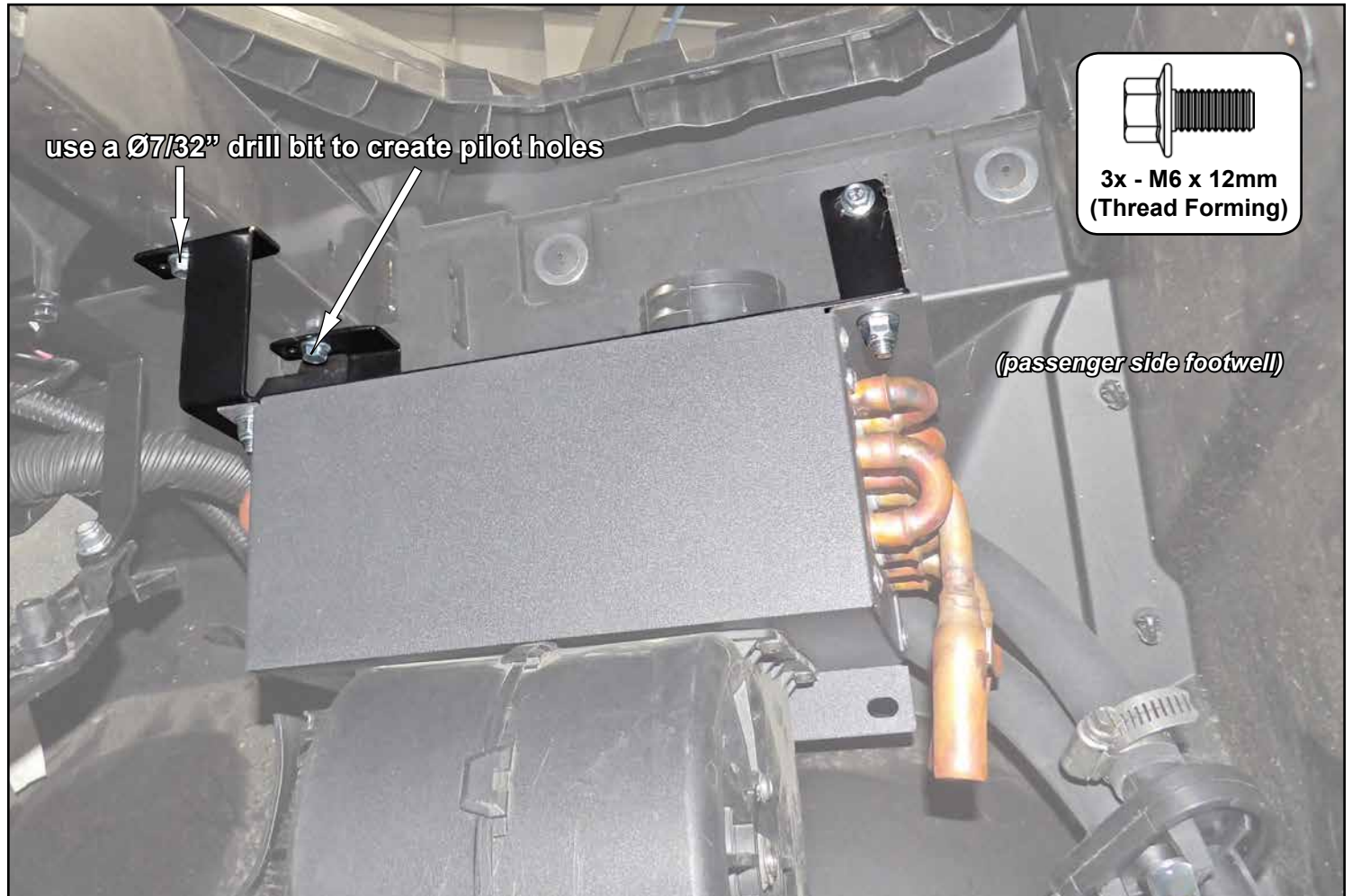
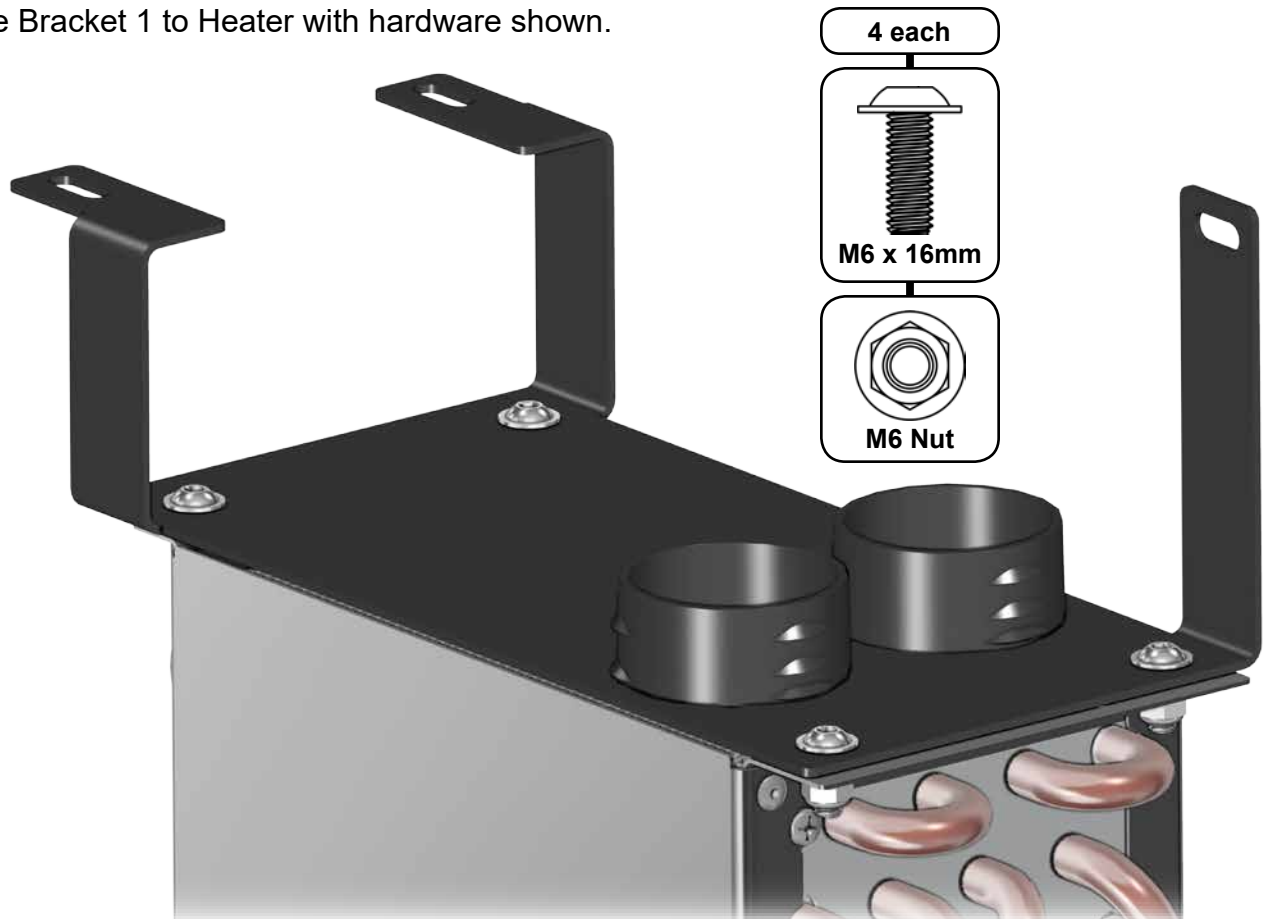

- Connect Tubing to Heater. Secure with Small Clamps.





Smart-Lok equipped machines only

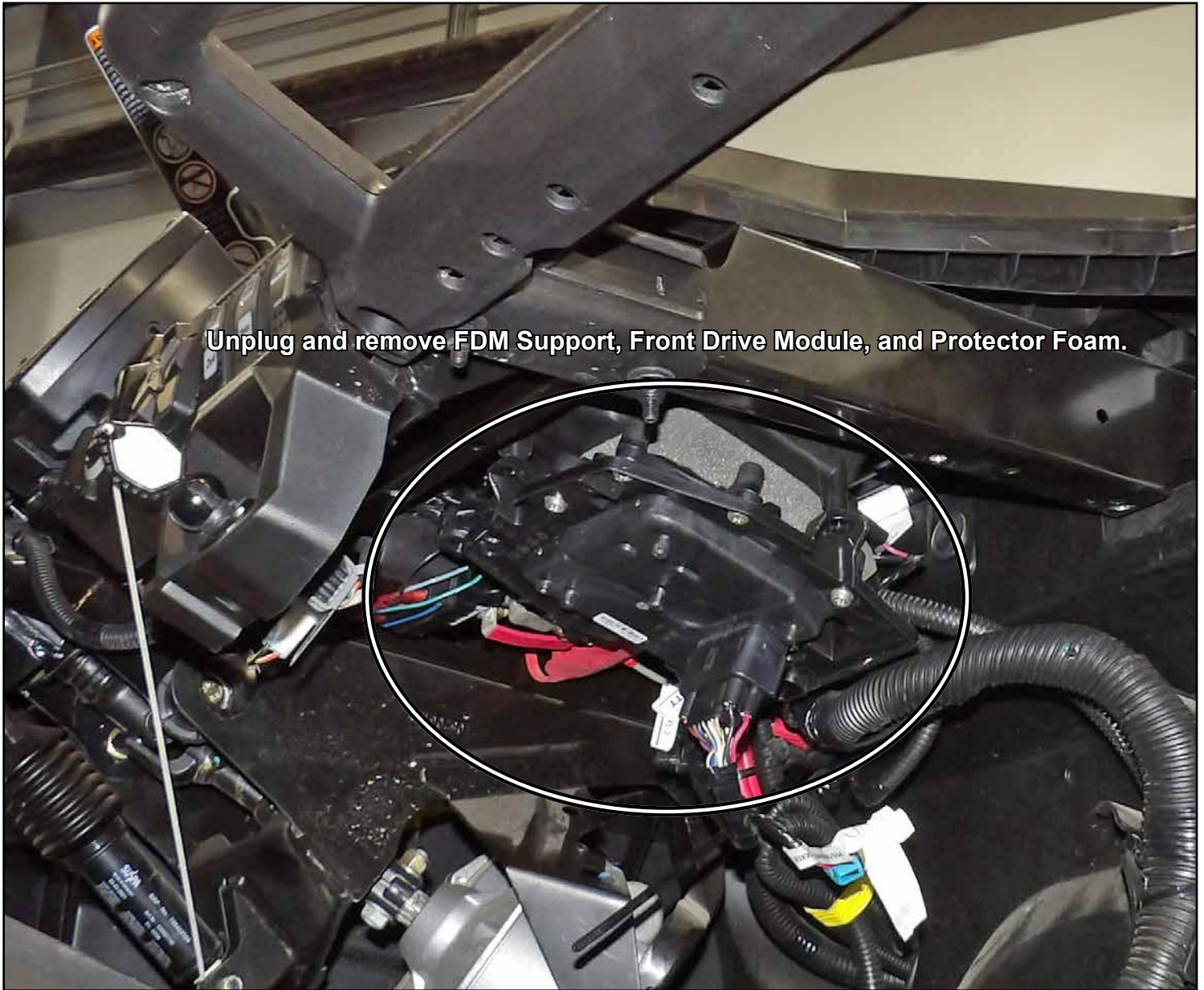

Unplug and remove FDM Support, Front Drive Module, and Protector Foam.

## Smart-Lok equipped machines only

- Secure Brackets 4 and 5 to stock Front Drive components with hardware shown; do not tighten.

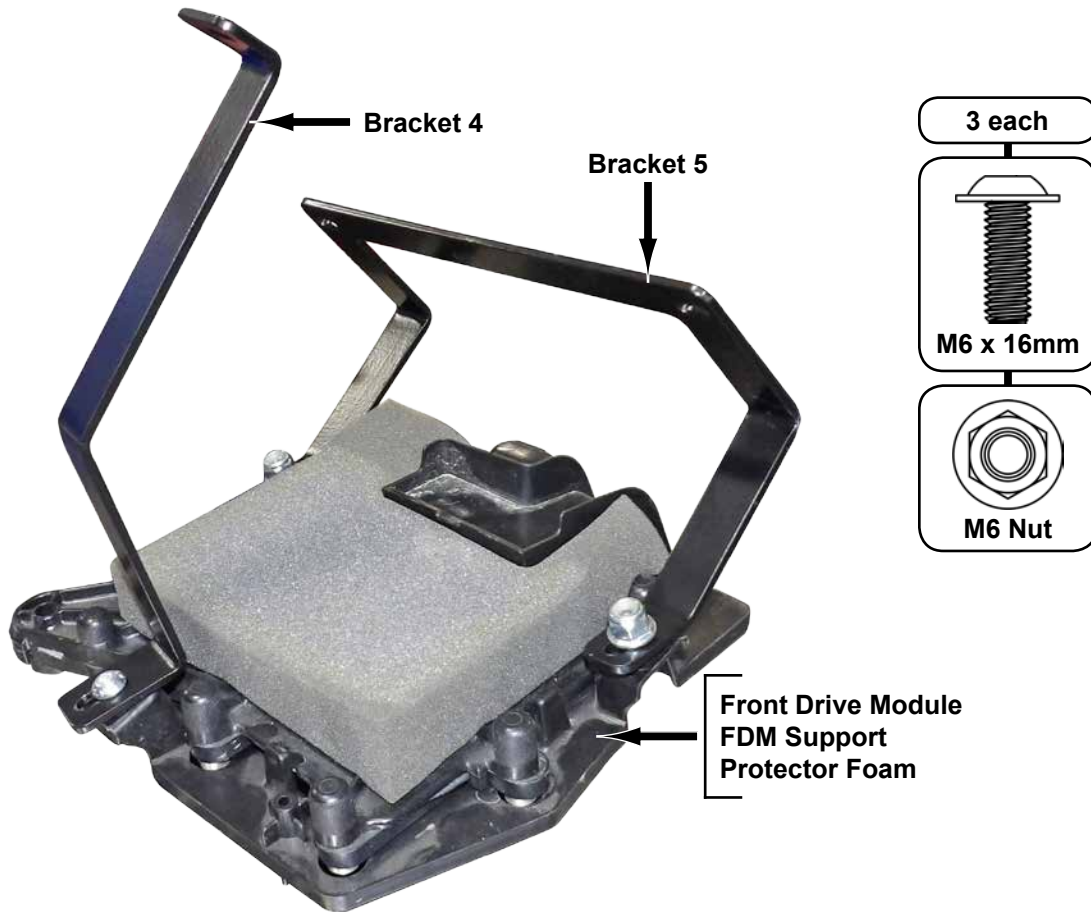

- Secure Brackets 4 and 5 to stock location with stock hardware; tighten all hardware.

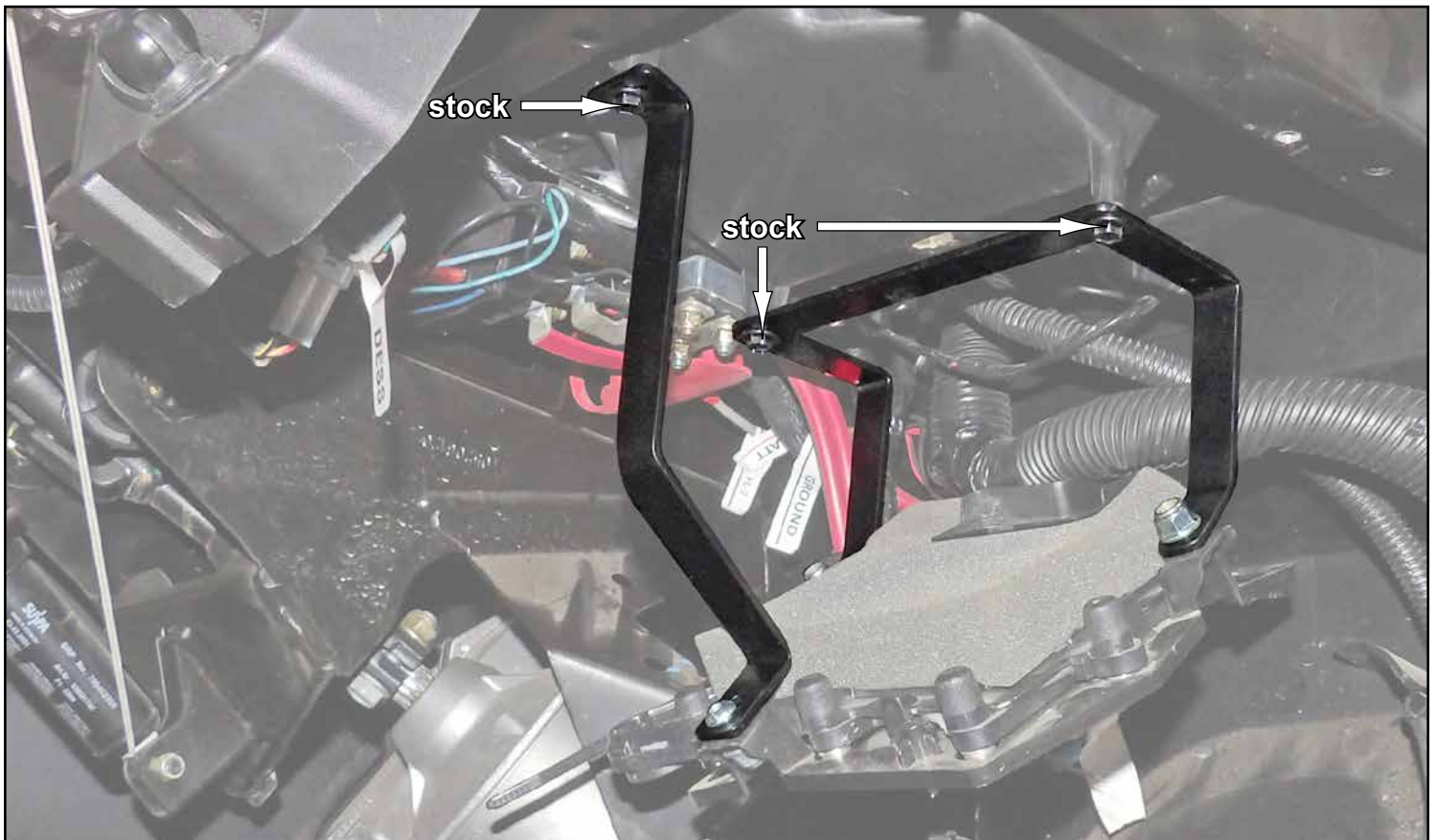



- Secure Bracket 3 with hardware shown; tighten.

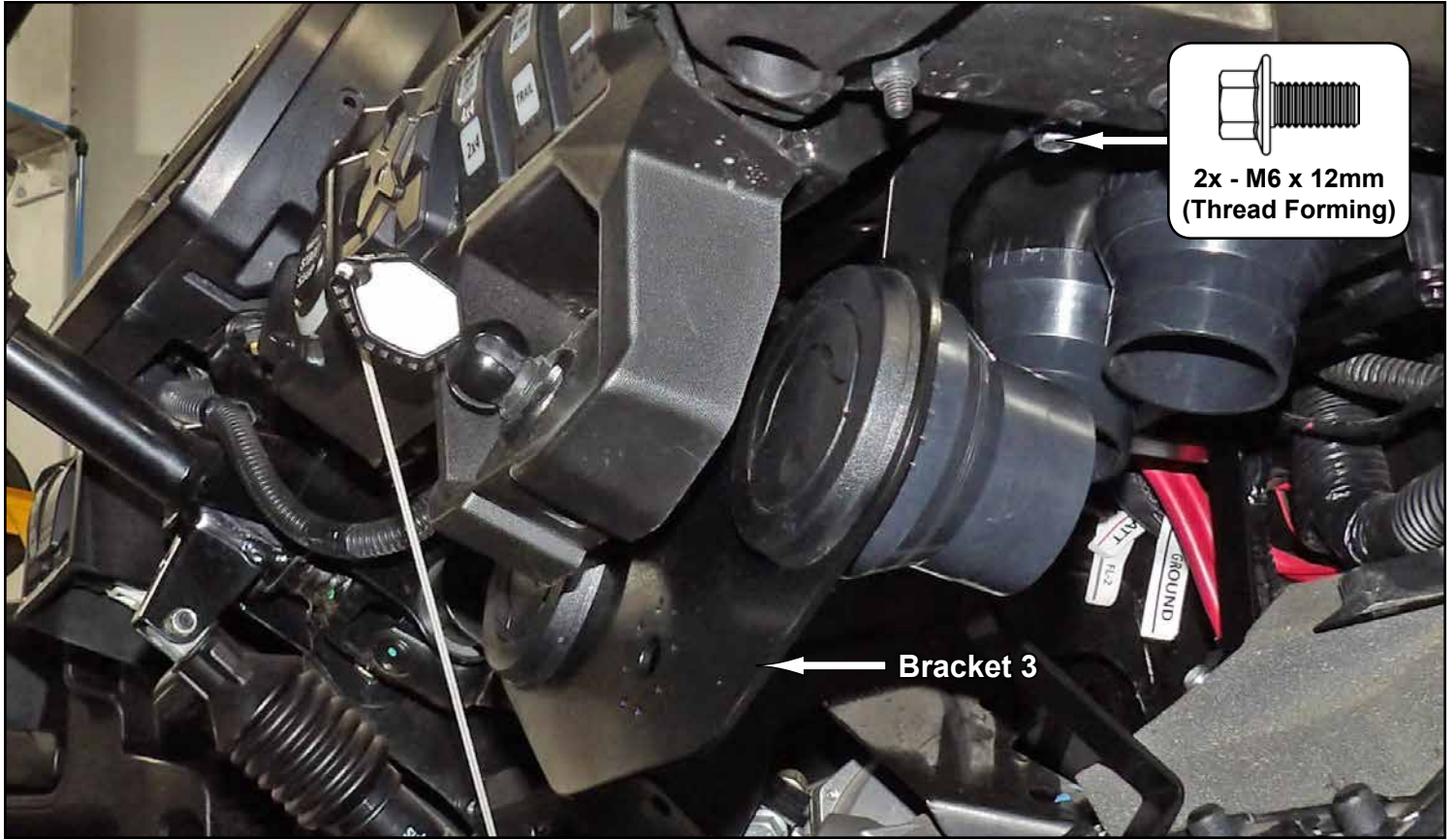

- Connect Ducting Assembly 1 to Dash Vents and Adapter.
- Secure with Wire Ties.

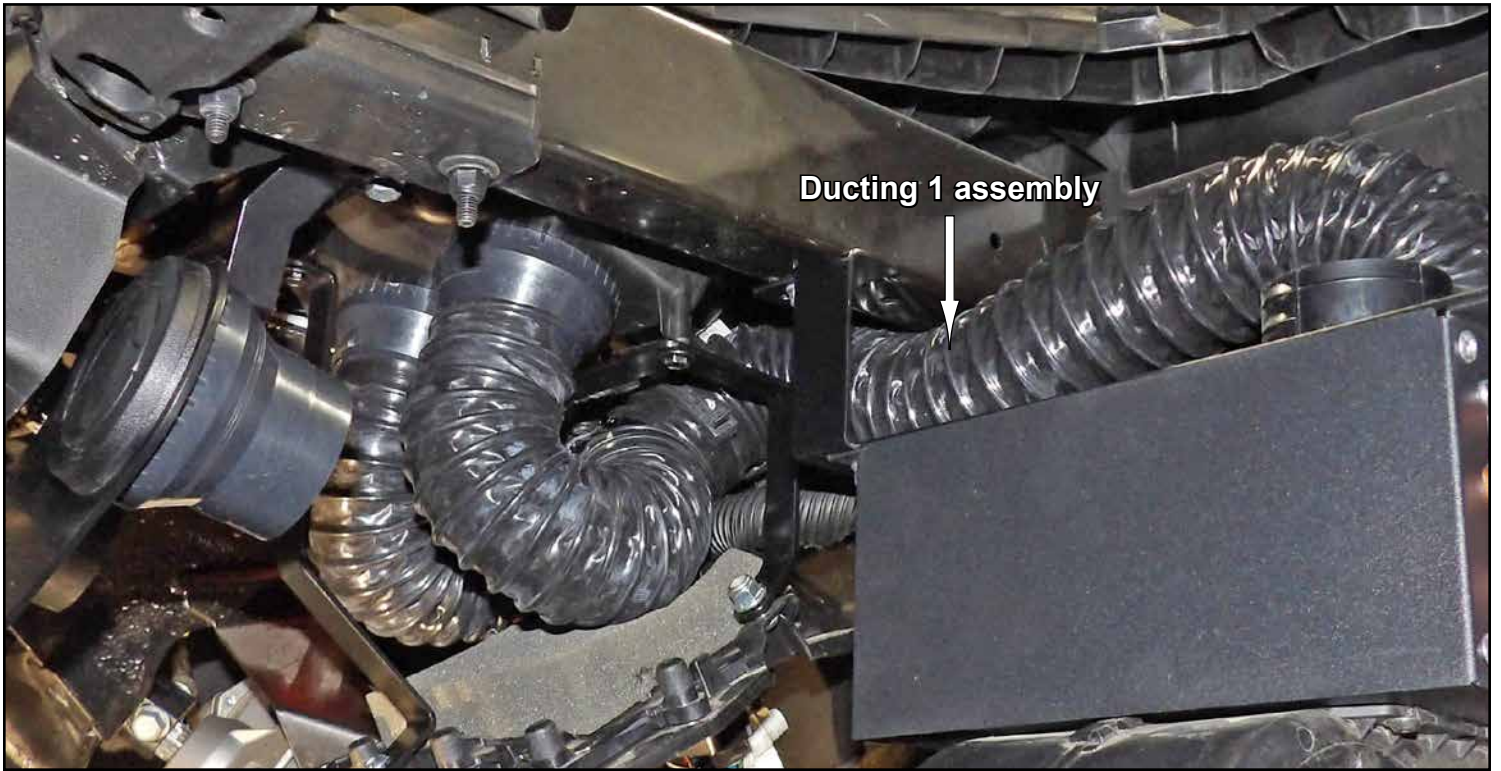

- Connect Ducting Assembly 2 to Vents on Bracket 3 and Adapter.
- Secure with Wire Ties.





- Raise front of vehicle and place on jack stands.
- Remove Lower Radiator Hose and drain coolant.
- Hold Adapter up to stock Hose and mark locations to be cut.
- Cut stock Hoses and install Adapters with Clamps as shown.

To prevent stock Radiator Hoses from being cut short, use provided Adapters as templates.

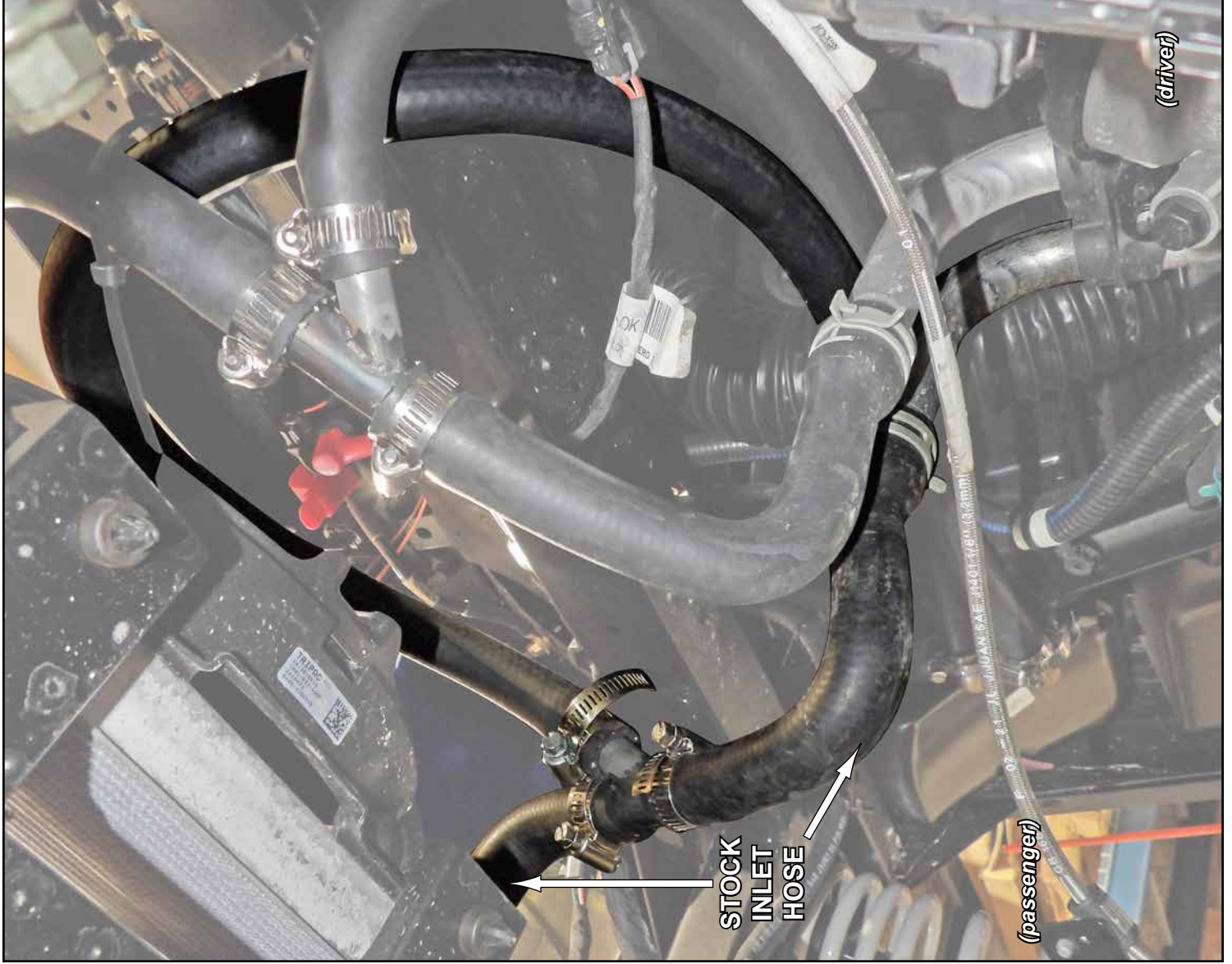
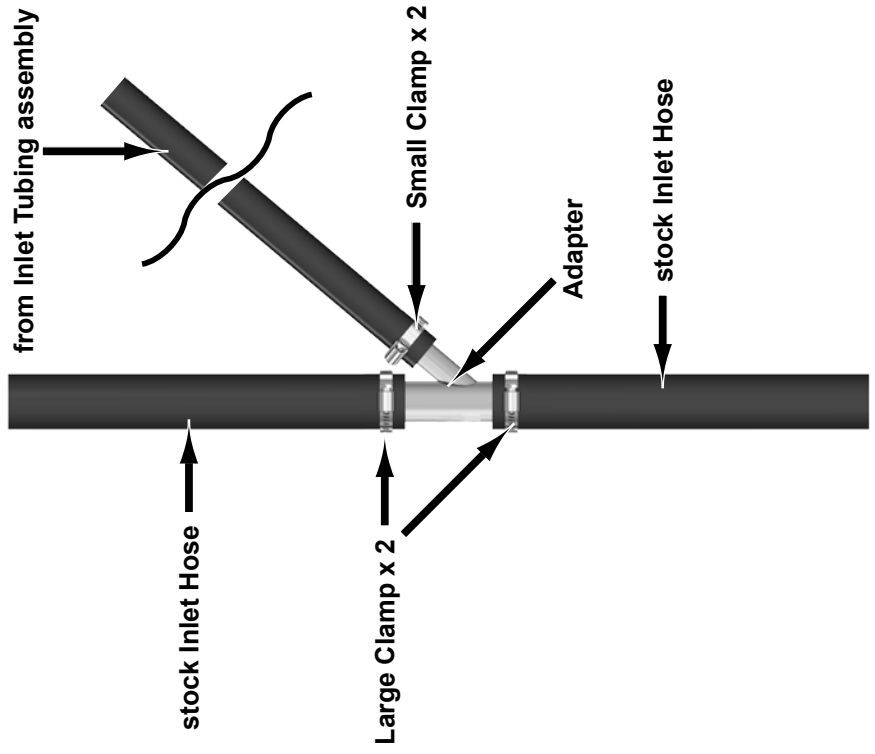

- Hold Adapter up to stock Hose and mark locations to be cut.
- Cut stock Hose and install Adapter with Clamps as shown.

To prevent stock Radiator Hoses from being cut short, use provided Adapters as templates.

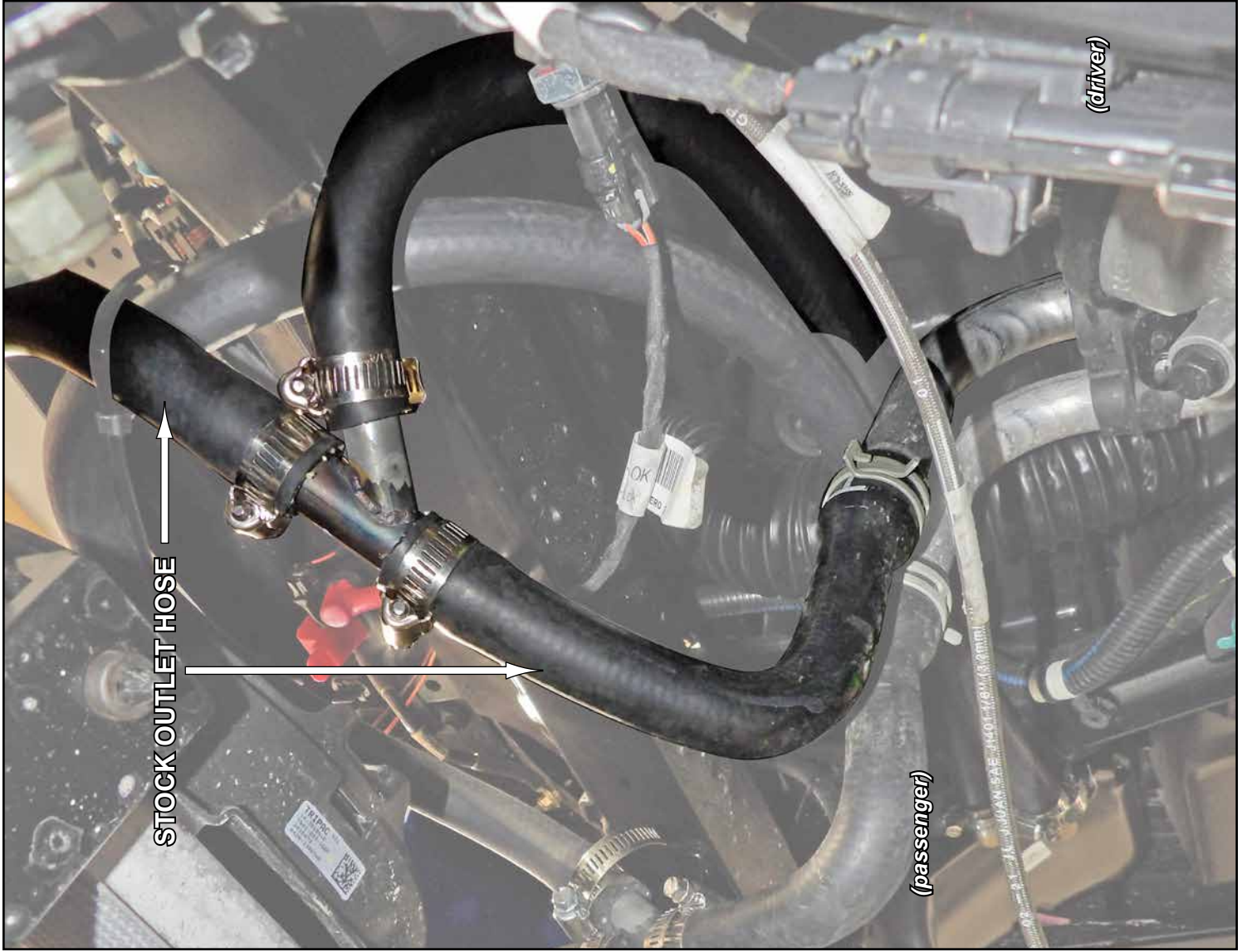
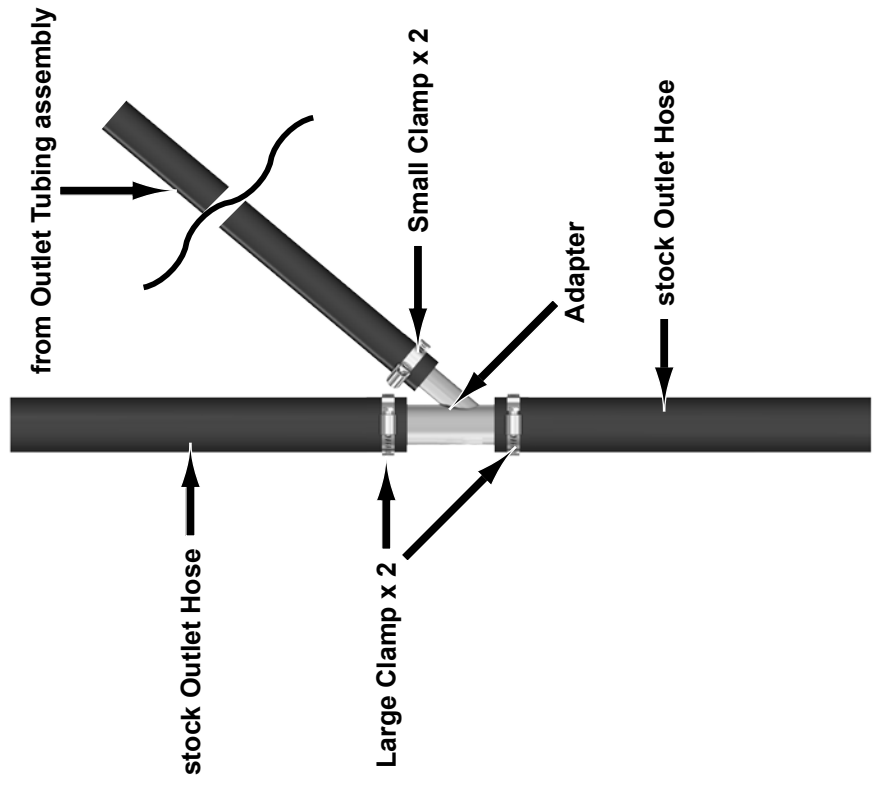



- Reinstall Deflector.

- Place machine back on ground.
- Fill coolant level to manufacturers recommended setting.
- Start machine and run at 3000 RPM until engine is hot.
- Use provided Hose Pliers and pinch off Inlet Hose as shown below.

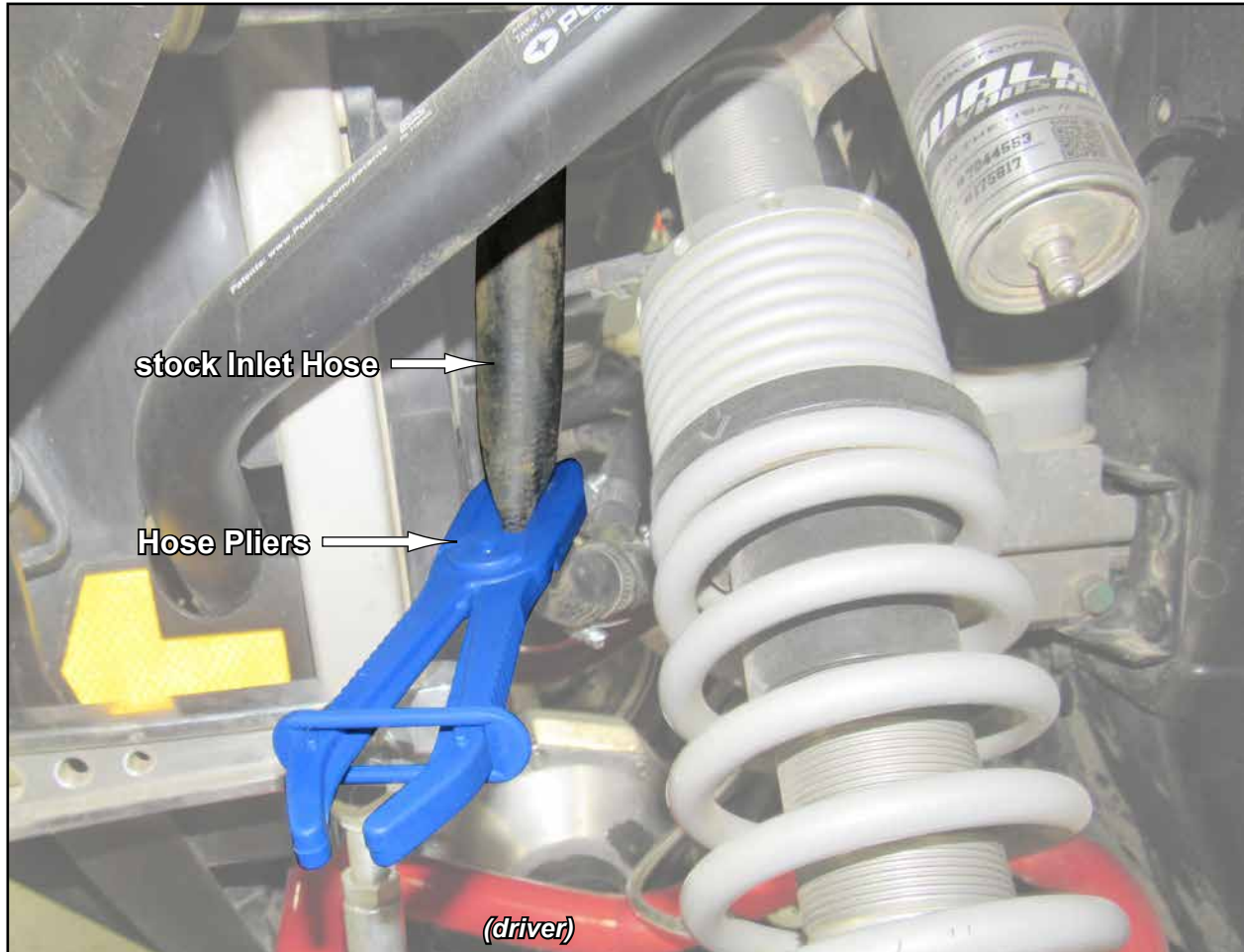

- Remove Hose Pliers after Radiator Fan turns ON.
- After Radiator Fan turns OFF, pinch Inlet Hose again and remove after Radiator Fan turns ON.
- Turn machine off and let engine completely cool; may take several hours.
- Check Coolant Level in Radiator and Reservoir; adjust as needed.
- Start machine and repeat “pinch” steps again.