

- Do not discard packaging until product has been successfully installed.
- Discard any remaining hardware.

Item	Description
A	Motor Mount
B	Upper Shaft
C	Lower Shaft
D	ECU Mount

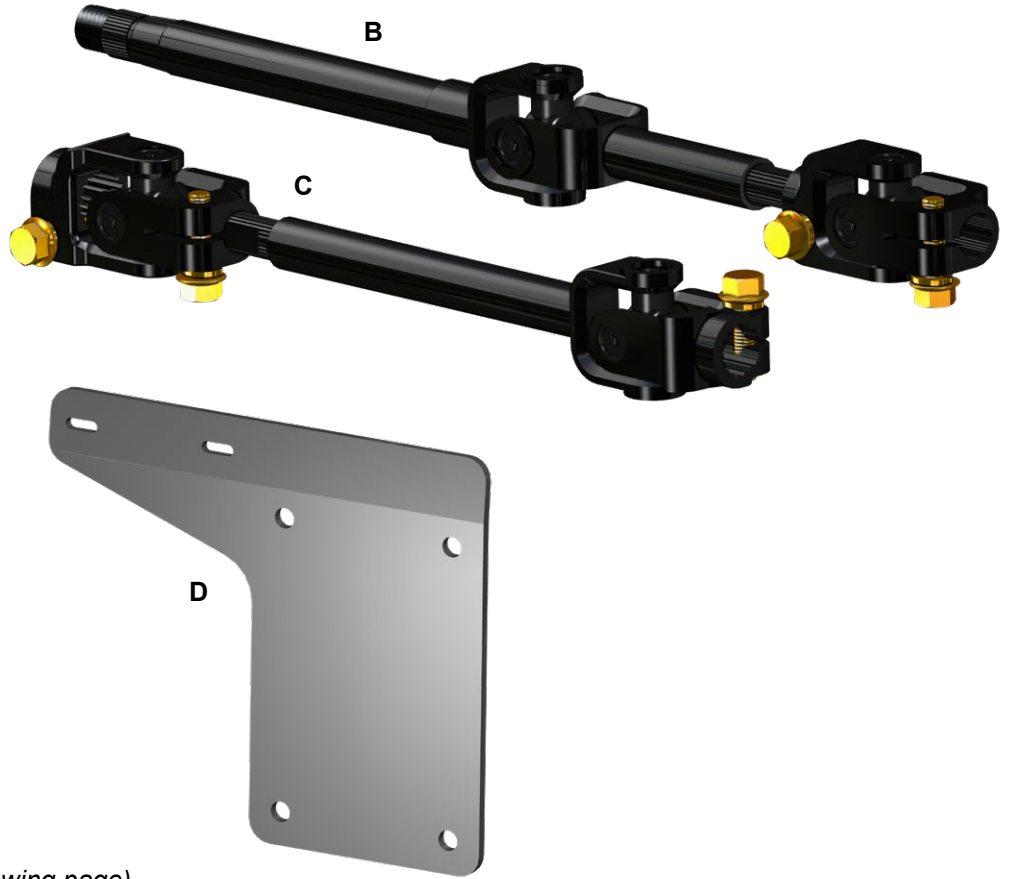

(Kit contents continue on following page)

Liability Statement

SuperATV's[®] products are designed to best fit user's ATV/UTV under stock conditions. Adding, modifying, or fabricating any factory or aftermarket parts will void any warranty provided by SuperATV[®] and is not recommended. SuperATV's[®] products could interfere with other aftermarket accessories. If user has aftermarket products on machine, contact SuperATV[®] to verify that they will work together.

Although SuperATV[®] has thousands of satisfied customers, user should be aware that installing lift kits, long travel, or suspension kits, tires, etc. will change the ride of machine and may increase maintenance and part wear. Operating any off-road machine while, or after, consuming alcohol and/or drugs increases risk of bodily harm or death. No warranty or representation is made as to this product's ability to protect user from severe injury or death. SuperATV[®] urges operators and occupants to wear a helmet and appropriate riding gear at all times.

By purchasing and installing SuperATV[®] products, user agrees that should damages occur, SuperATV[®] will not be held responsible for loss of time, use, labor fees, replacement parts, or freight charges. SuperATV[®], nor any 3rd party, will not be held responsible for any direct, indirect, incidental, special, or consequential damages that result from any product purchased from SuperATV[®]. The total liability of seller to user for all damages, losses, and causes of action, if any, shall not exceed the total purchase price paid for the product that gave rise to the claim.

SuperATV[®] will warranty only parts provided by SuperATV[®]. Any damage or problems with OEM housings, bearings, seals, or other manufacturers' products will not be covered by SuperATV[®]. SuperATV[®] parts and products are not warranted if item was not installed properly, misused, or modified.

Installing, adding, modifying, or fabricating any factory or aftermarket product to your ATV/UTV may violate certain local, state, and federal laws. Be advised that laws vary depending on town, city, county, state, etc. Use of certain products on public streets, roads, or highways may be in violation law. The Buyer is solely and exclusively legally and personally responsible for any violation of the law by the installation or use of the product. You must abide by all local, state, and federal laws, including but not limited to vehicle safety, traffic laws, and ordinances. It is your responsibility to know the laws and how they apply to you.

The Buyer is responsible to fully understand the capability and limitations of his/her vehicle according to manufacturer specifications, warnings and instructions and agrees to hold SuperATV[®] harmless from any damage resulting from failure to adhere to such specifications, warnings and/ or instructions. The Buyer is also responsible to obey all applicable federal, state, and local laws and ordinances when operating his/her vehicle while using this product, and the Buyer agrees to hold SuperATV[®] harmless from any violation thereof.

Need help with your installation?

 sales@superatv.com
 www.superatv.com
 1-855-743-3427
  8:00am - 8:00pm EST M-Th
 8:00am - 7:00pm EST Friday
 9:00am - 2:00pm EST Saturday

Read instructions and view illustrations before beginning.

Thank You
For Choosing
SUPERATV.COM[®]

(Kit contents continued)

Item	Description
G	Motor
H	ECU
J	Harness

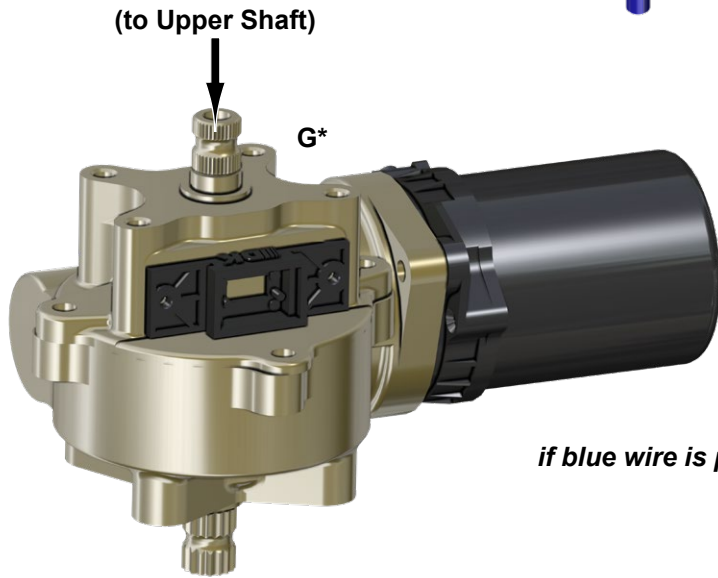
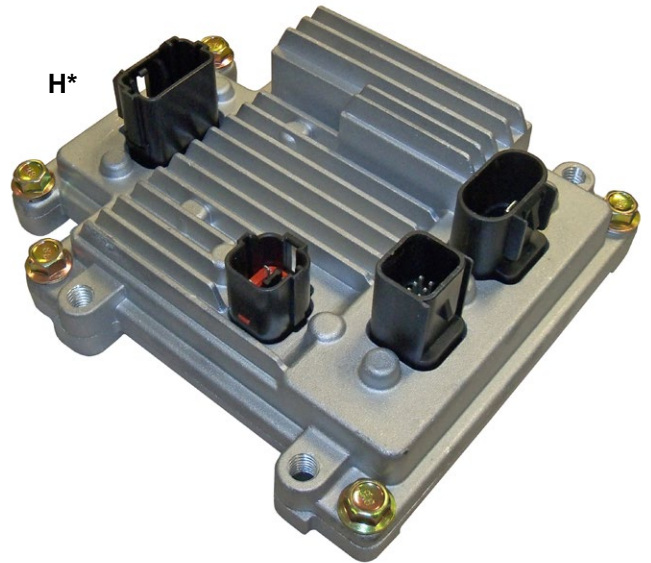

route to Accessory Block

if blue wire is present, cut and discard



*Connections

- Before installing, ensure that all Gaskets in electrical connections are properly seated.
- If Gaskets are not seated use a Flathead Screwdriver to seat.

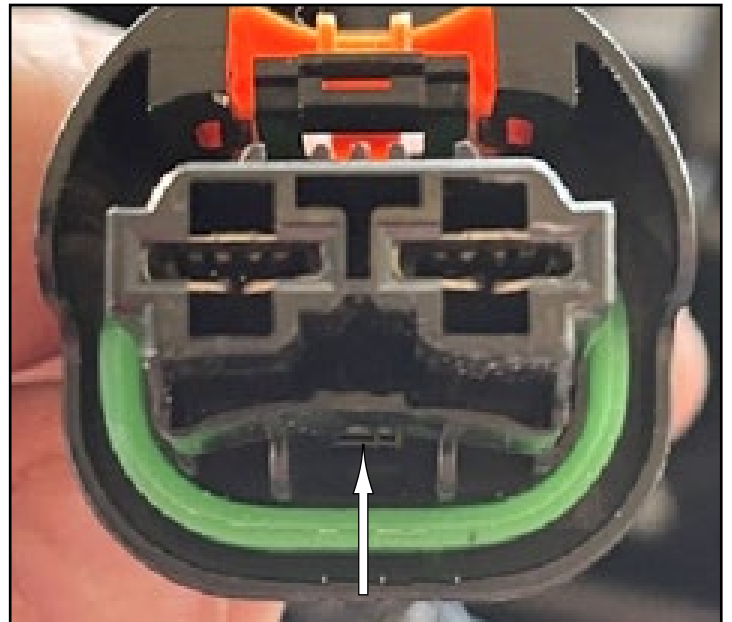

On **600W Motor Connector**, where arrow is pointing, is a small spring which needs to be slightly nudged up when plugging in.

Removal: *Keep all components removed from machine.*

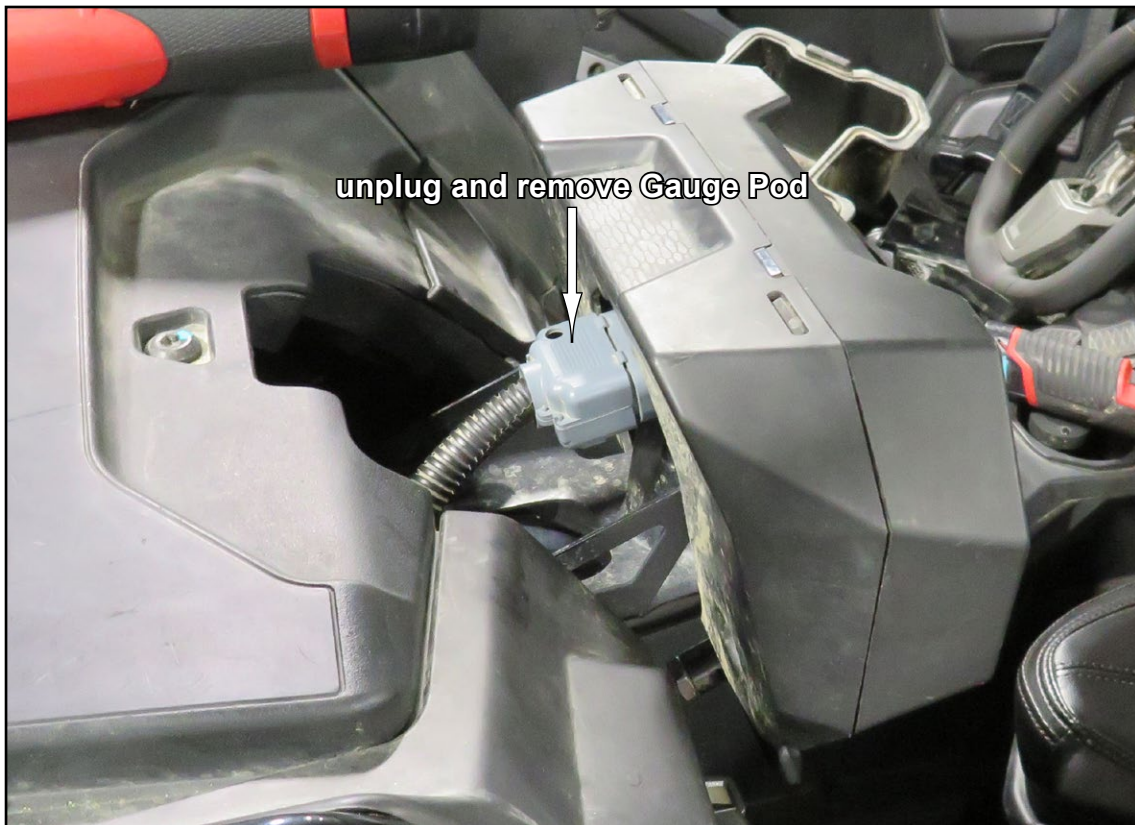

Removal continued:

- Unbolt Lower Shaft from Motor and Rack and Pinion.

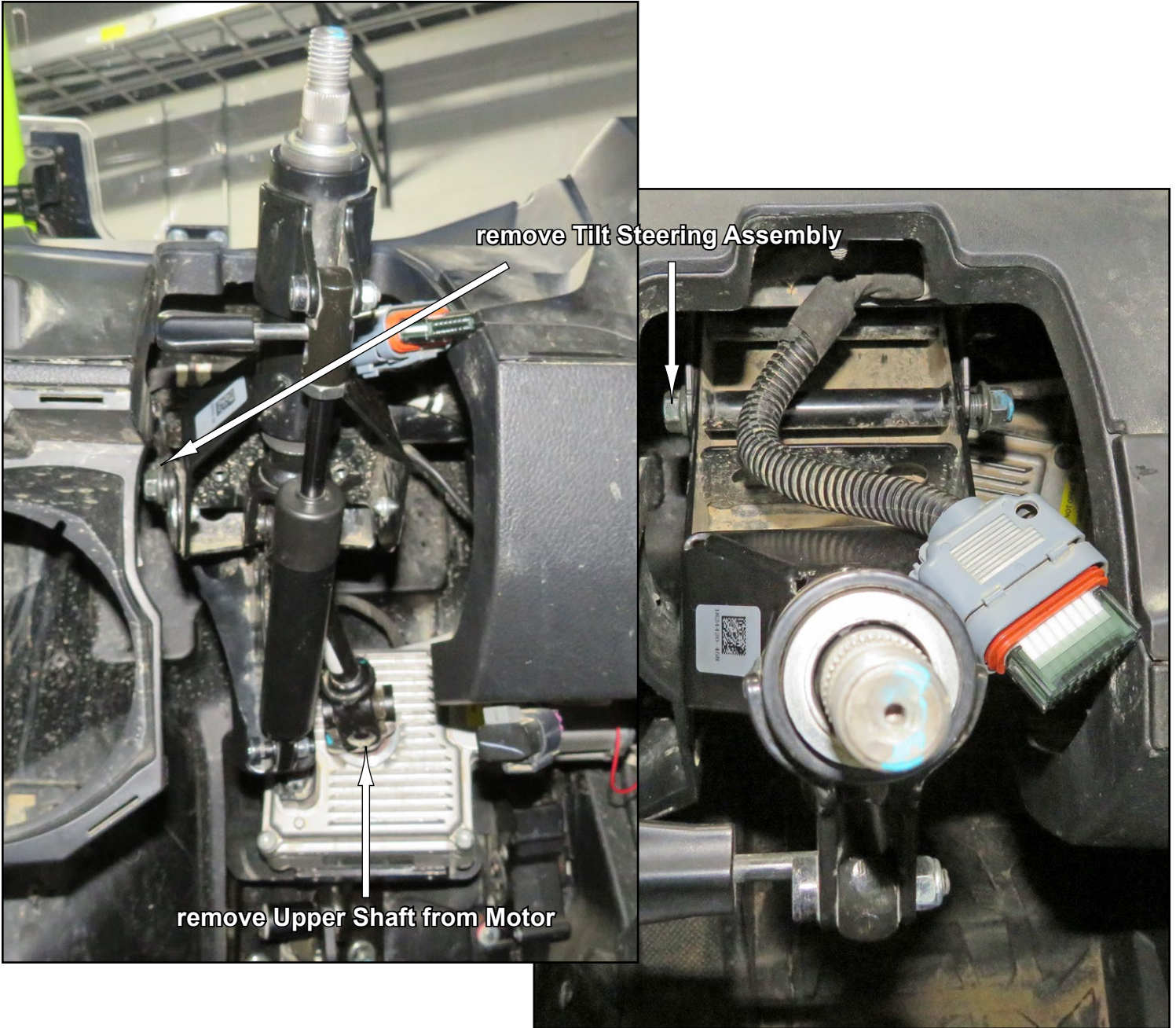

- Remove Tilt Steering / Upper Shaft assembly from machine.

Removal continued:



- Remove Mount / Motor assembly from machine.



- Insert Lower Shaft (C) through Firewall and secure to Rack and Pinion with provided hardware on Shaft; tighten.

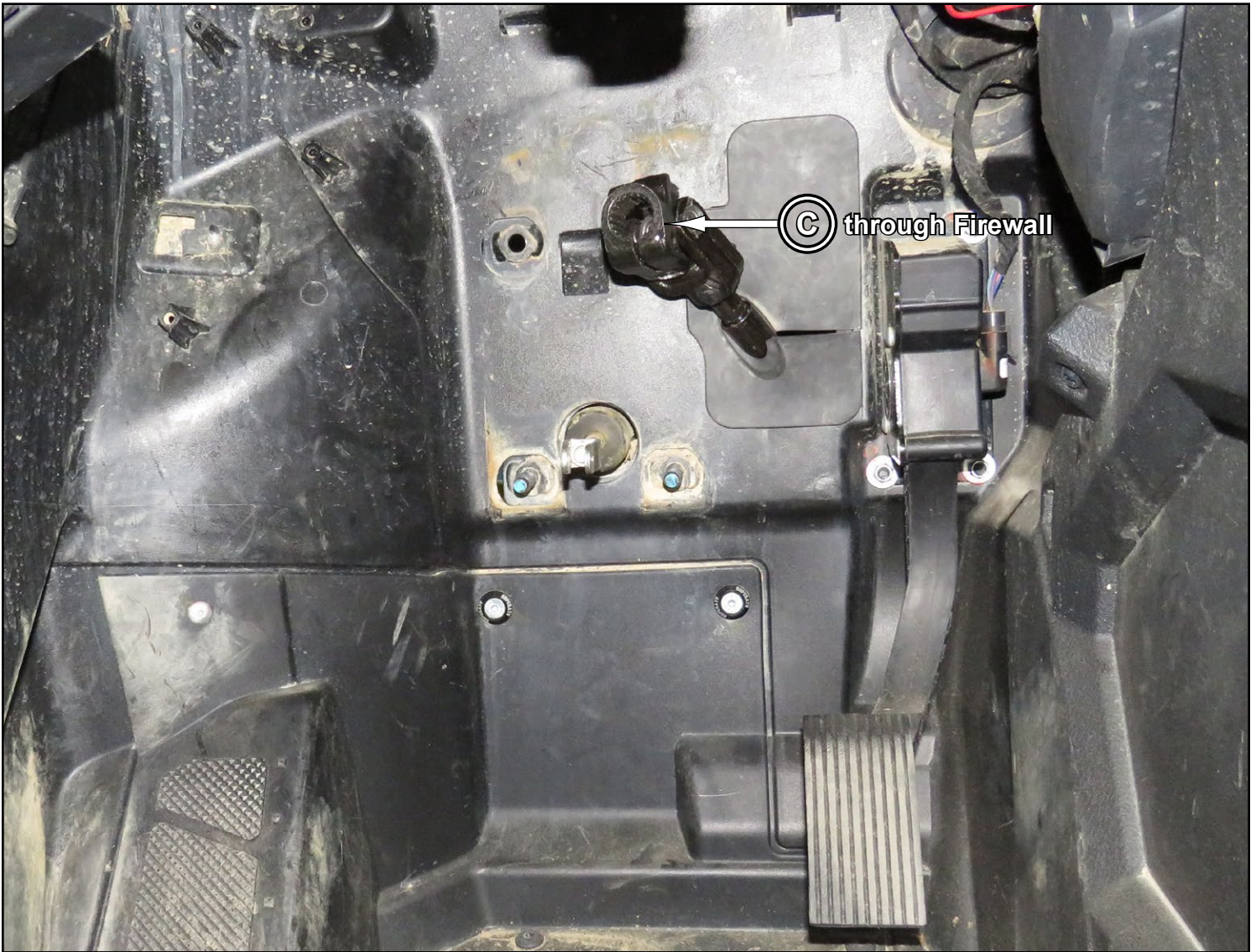

- Install ECU (H) to ECU Mount (D) with hardware shown; tighten.

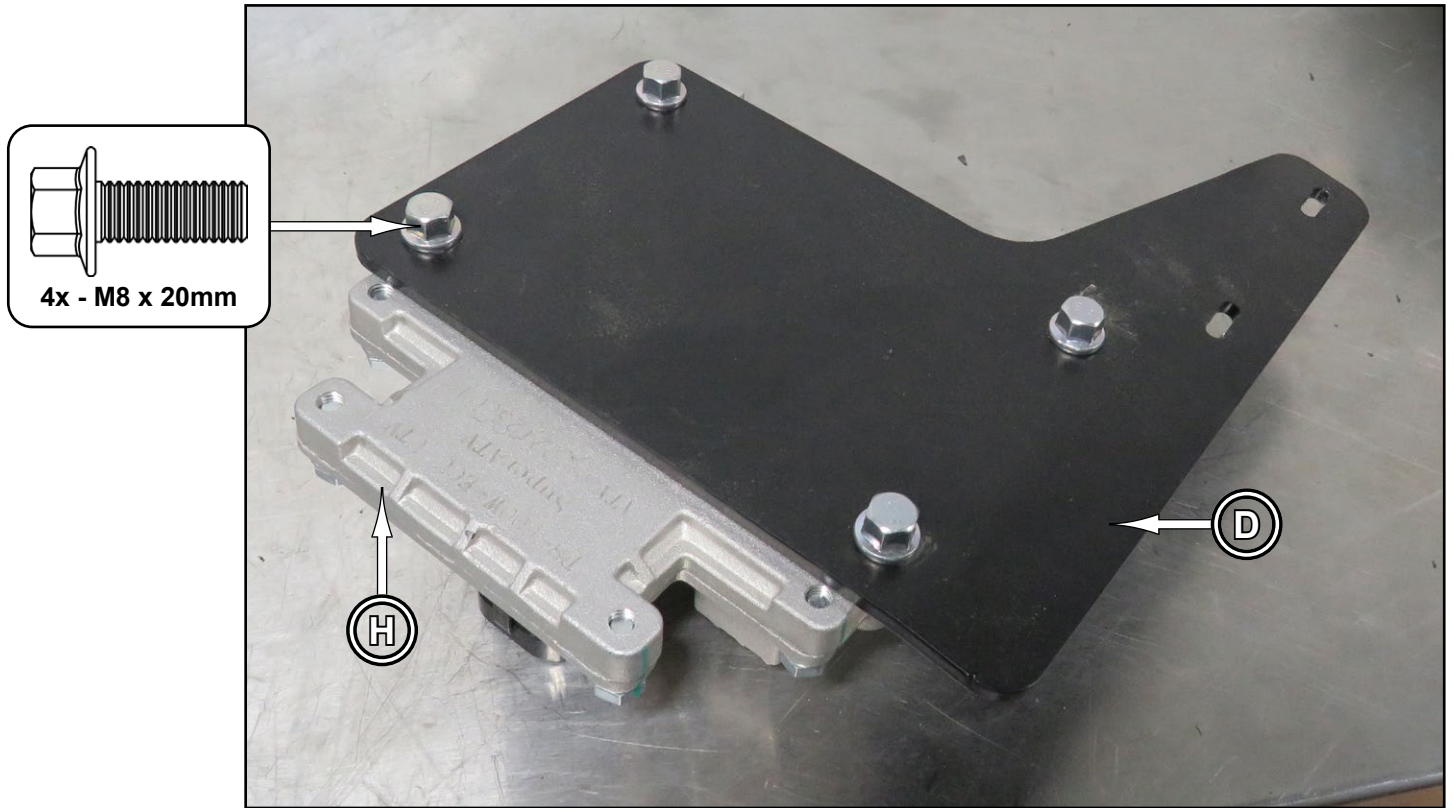

- Connect Harness (J) to ECU (H).

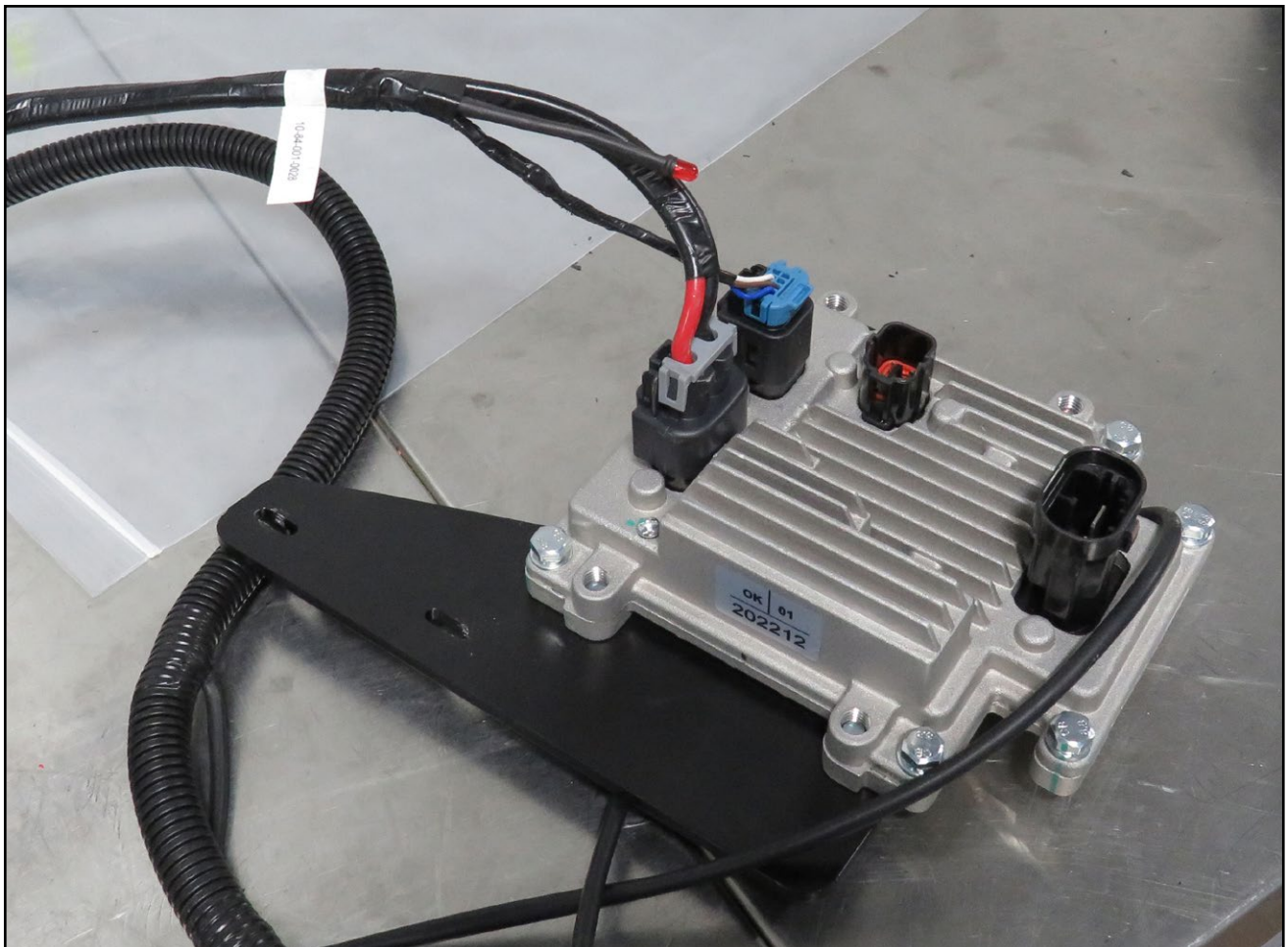

- Secure ECU Mount (D) to machine with hardware shown; tighten.

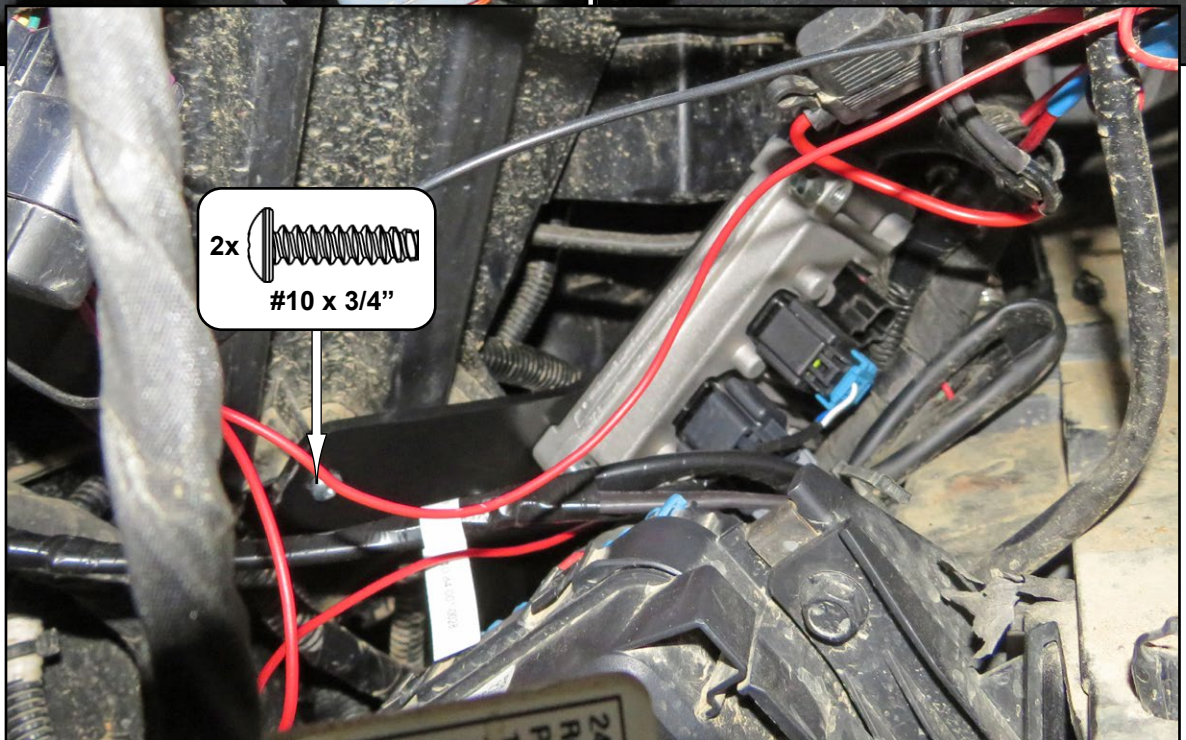
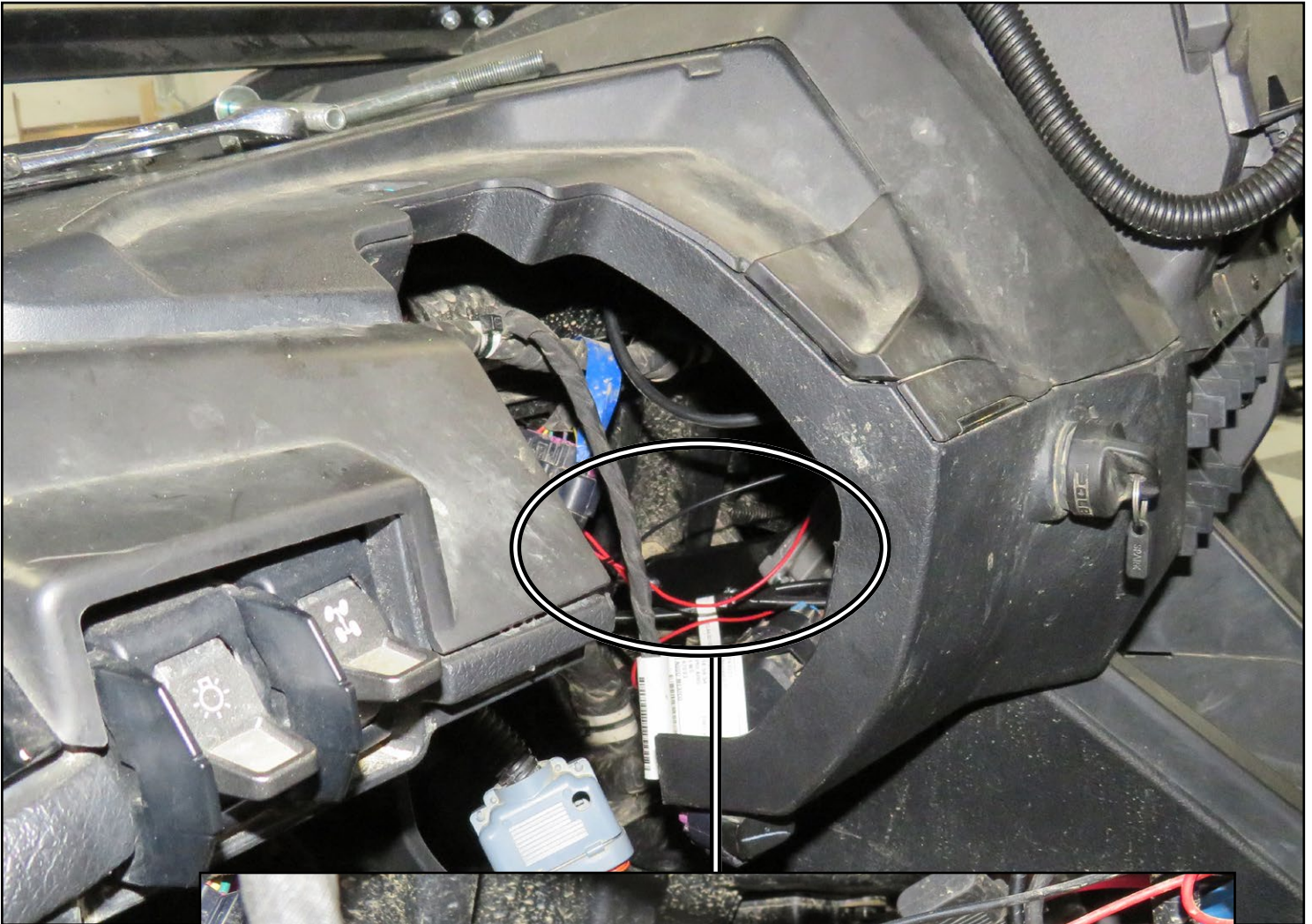

- Transfer all Brake Pedal components to Motor Mount (A).

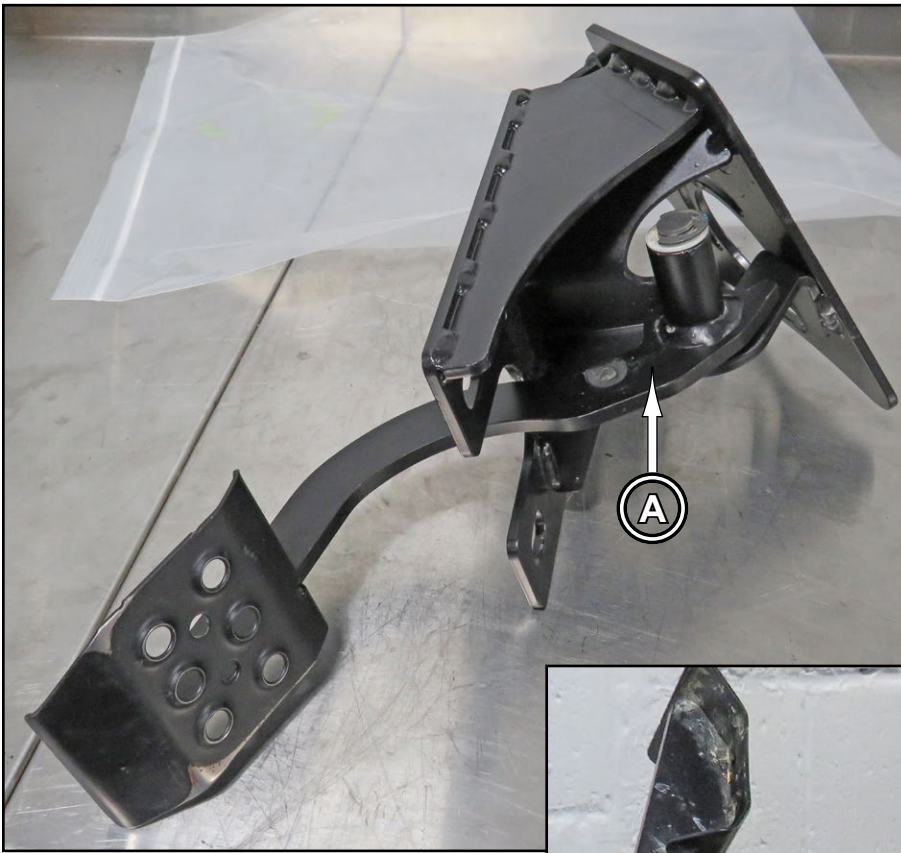

- Install Motor (G) to Motor Mount (A) with hardware shown.

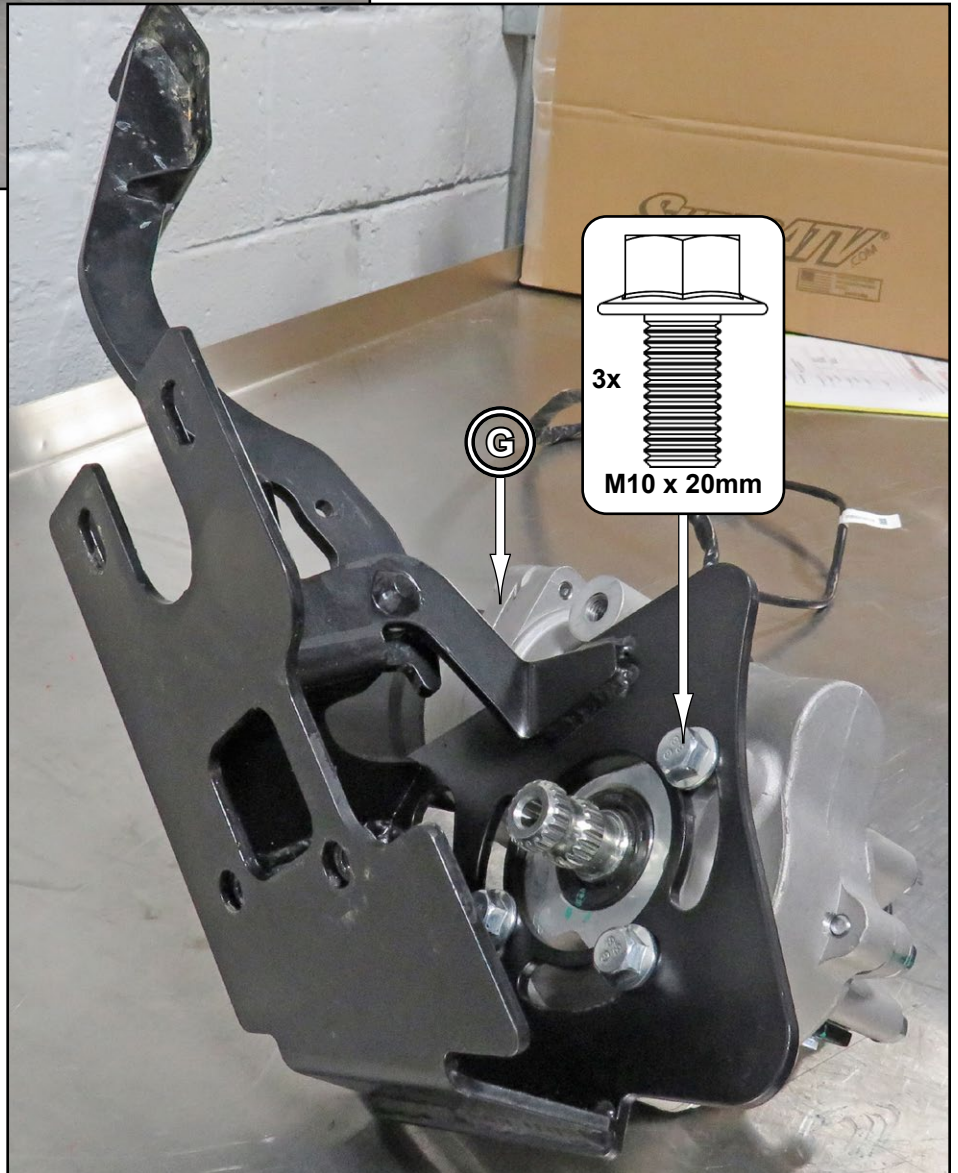

- Install Motor Mount/Motor assembly onto Lower Shaft (C):
 - Secure Lower Shaft (C) to Motor (G) with provided hardware; tighten.
 - Secure Motor Mount (A) to Pedal Mount Studs with stock Nuts; do not tighten.

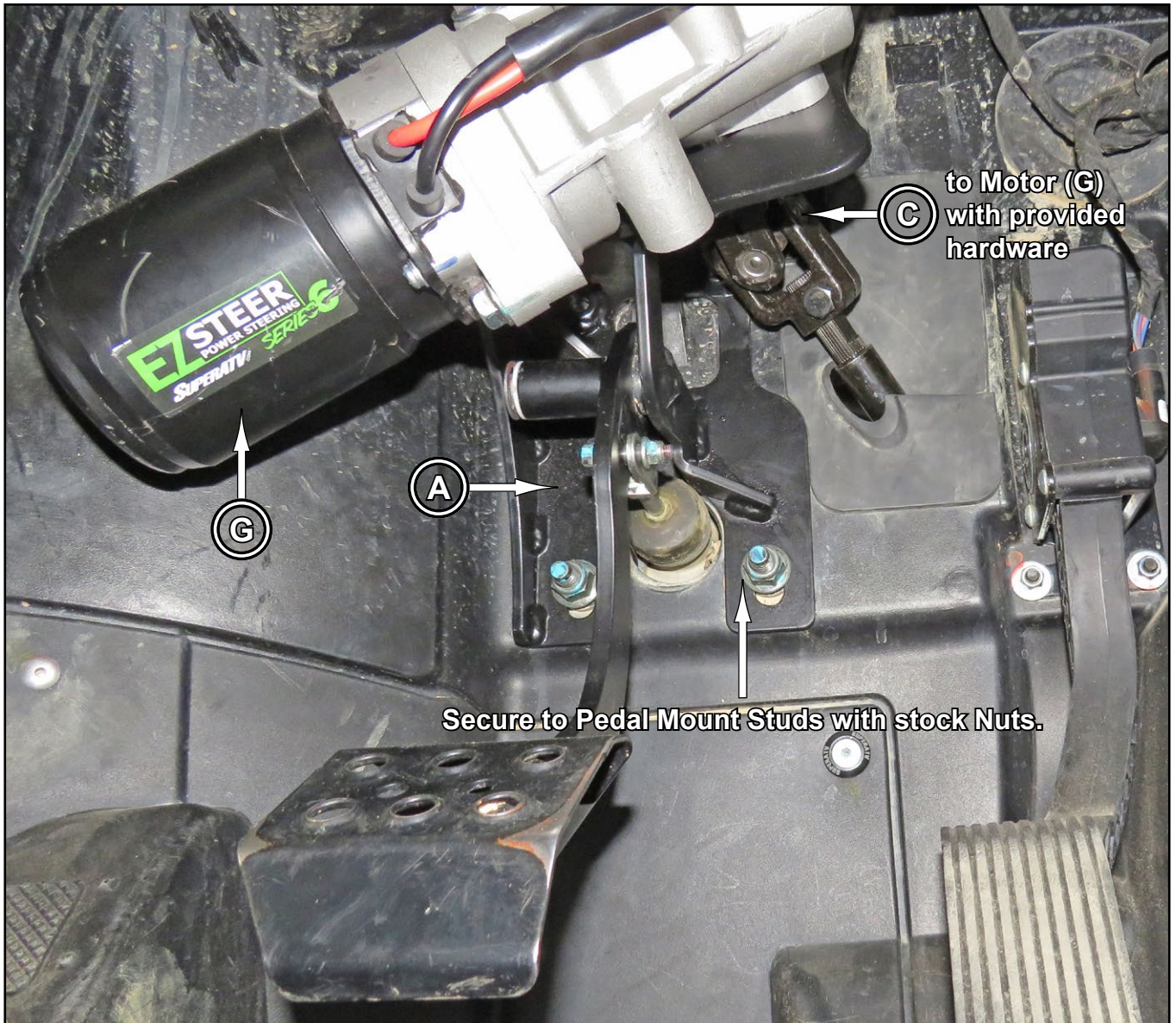

- Plug in Motor (G) connections to ECU (H).



- Insert Upper Shaft (B) into Tilt Steering Assembly. Reuse stock Bushings and Bearings.



- Secure Upper Shaft (B) to Motor (G) with provided hardware on Shaft.



- Reinstall Tilt Steering Assembly with stock hardware.
- Tighten **all** hardware.
- Reinstall applicable stock components; tighten hardware.

Wiring Details

Plug	Function
A	Motor
B	Main Power and Ground
C	Non-Contact Torque Sensor
D	Key-On Power, Speed Sensor Wire, and LED

Secure in a visible location.



When activated, Diagnostic Light will flash once for about (1) second before turning off indicating proper function. Should different patterns occur, contact SuperATV.

ECU Functions

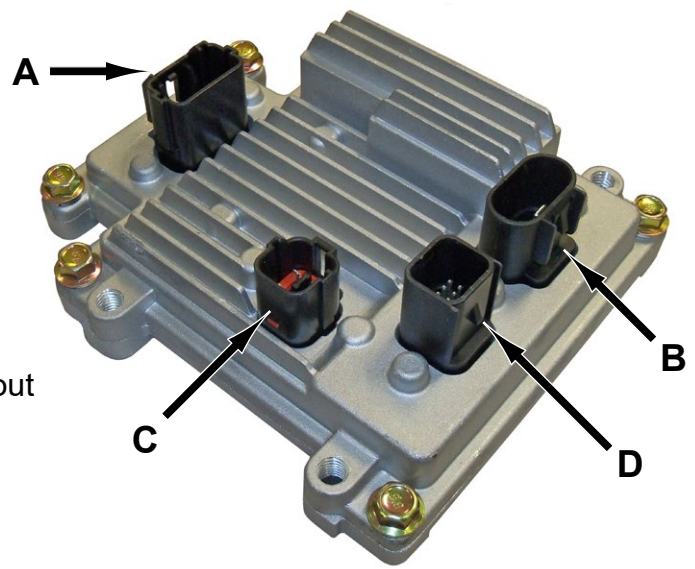

- Connect Harness (J) to Buss Bar in locations shown.

