

- **Front Sway Bar will be deleted with installation of this kit.**
- **A Press or Ball Joint tool is required to remove and install Ball Joints.**

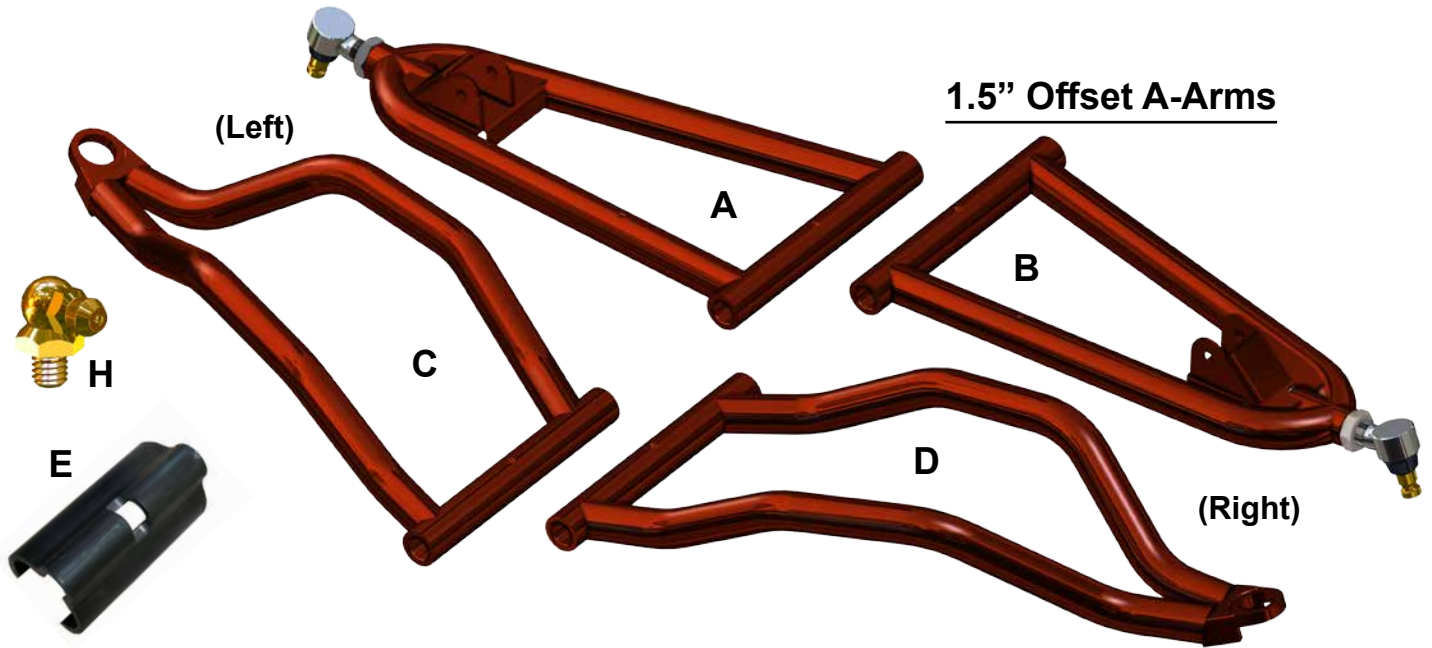

Item	Description	Qty
A	Front Upper A-Arm, Left	1
B	Front Upper A-Arm, Right	1
C	Front Lower A-Arm, Left	1
D	Front Lower A-Arm, Right	1
E	Brake Line Clips	4
F	Brake Line (Rear)	1
G	Brake Line (Front)	1
H	Grease Fittings	12

1.5" Offset A-Arms were used in installation illustrations

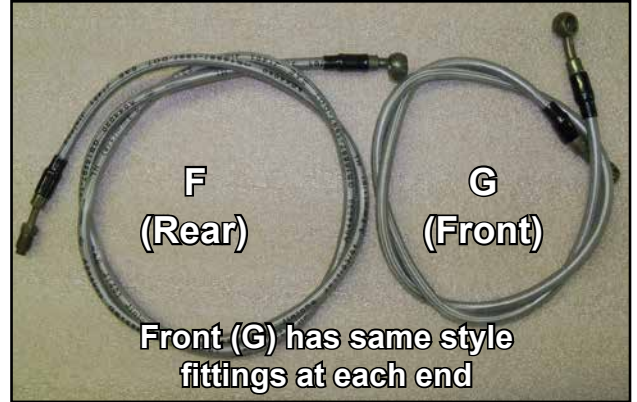

(Kit Contents continue on following pages)

Need help with your installation?

sales@superatv.com
 www.superatv.com

1-855-743-3427
 8:00am - 9:00pm EST M-Th
 8:00am - 7:00pm EST Friday
 9:00am - 2:00pm EST Saturday

Read instructions and view illustrations before beginning.

Thank You
 For Choosing
SUPERATV.COM[®]

(Kit Contents continued)

Item	Description
K	Rear Upper A-Arm, Left
L	Rear Upper A-Arm, Right
M	Rear Lower A-Arm, Left
N	Rear Lower A-Arm, Right

1.5" Offset A-Arms

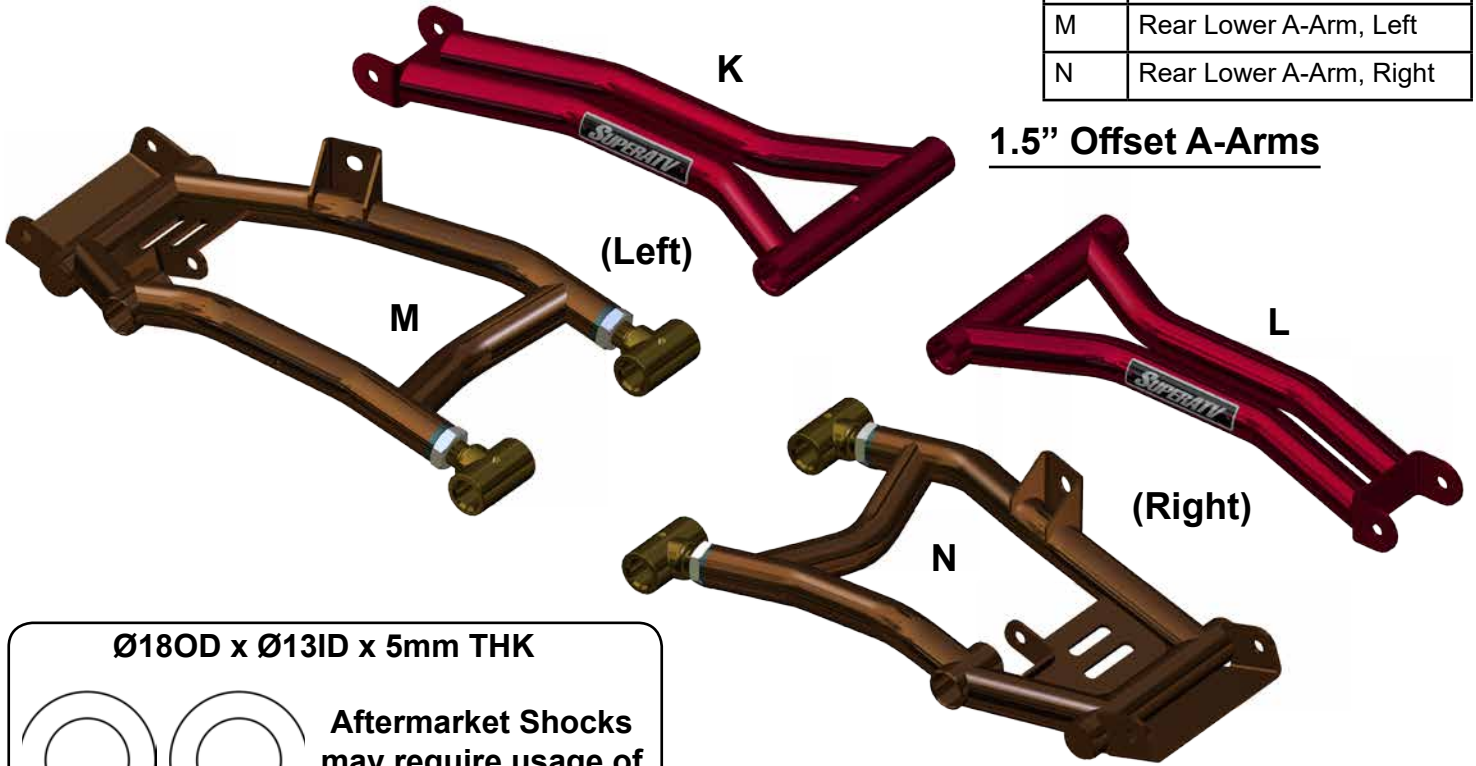

Ø18OD x Ø13ID x 5mm THK

Aftermarket Shocks may require usage of provided Spacers.

Tie Rod Kit*

**Depending on application Straight or Z-Bend Tie Rods will be used.*

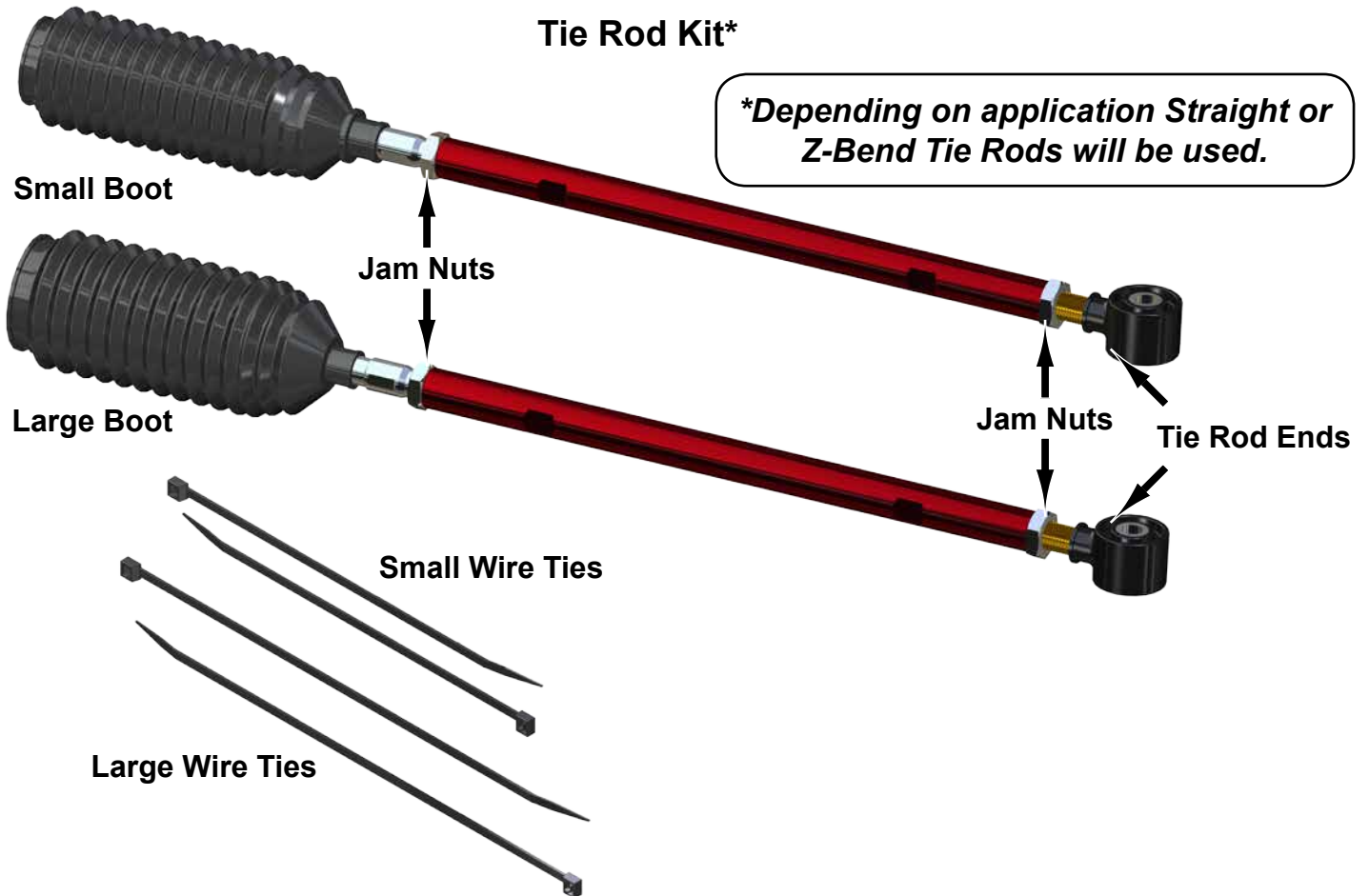

Zero Offset A-Arms

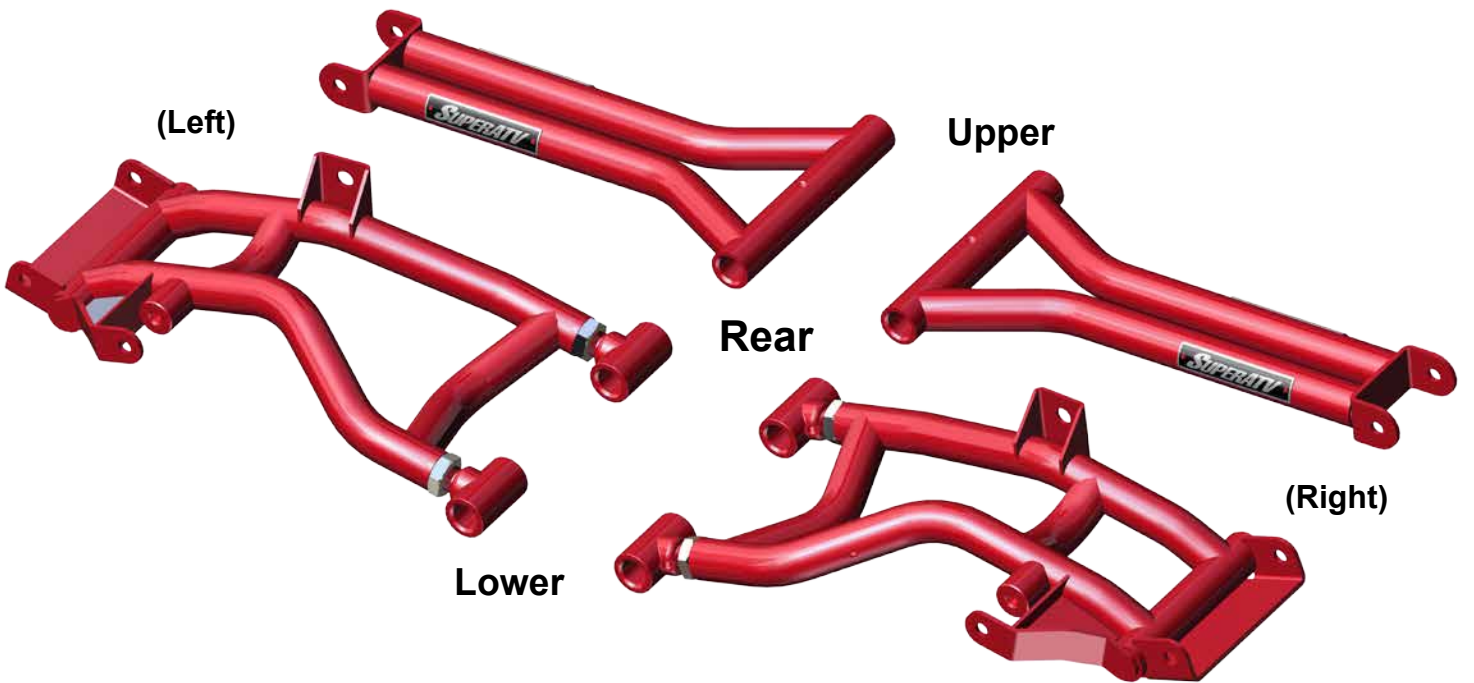
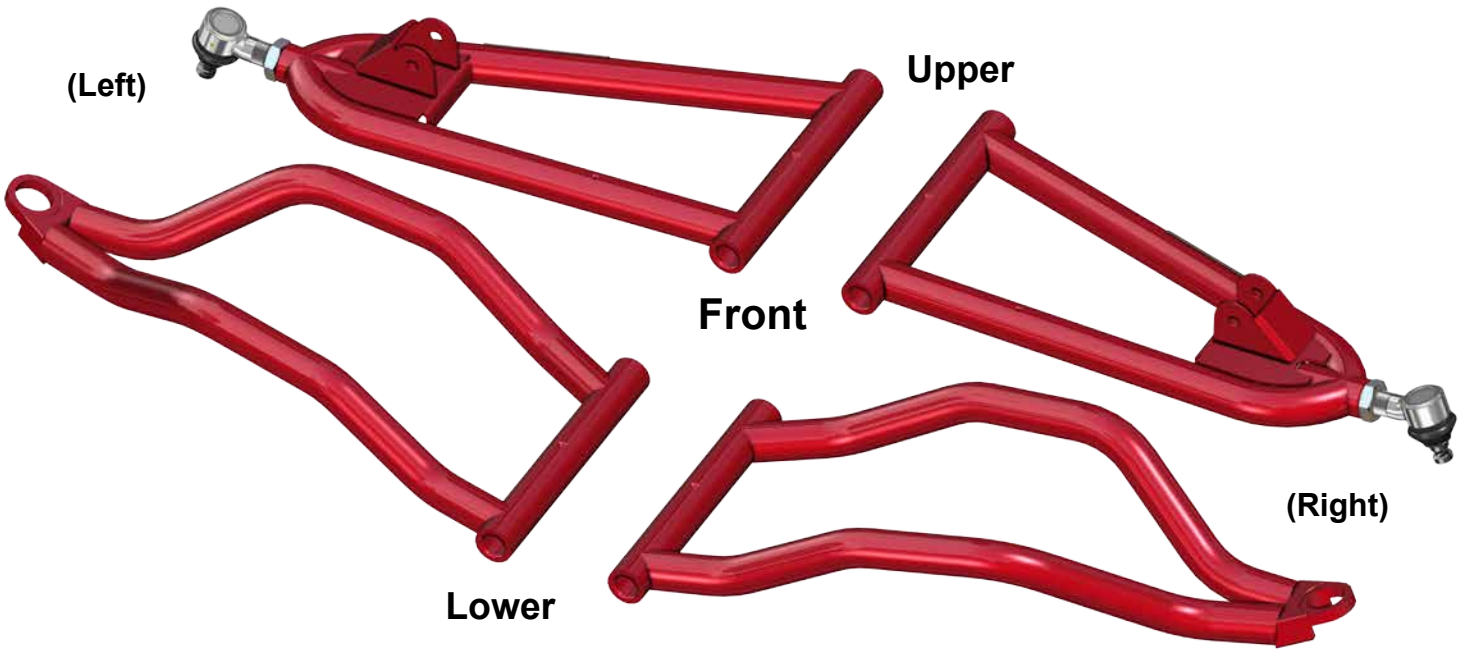

Liability Statement

SuperATV's® products are designed to best fit user's ATV/UTV under stock conditions. Adding, modifying, or fabricating any factory or aftermarket parts will void any warranty provided by SuperATV® and is not recommended. SuperATV's® products could interfere with other aftermarket accessories. If user has aftermarket products on machine, contact SuperATV® to verify that they will work together.

Although SuperATV® has thousands of satisfied customers, user should be aware that installing lift kits, long travel, or suspension kits, tires, etc. will change the ride of machine and may increase maintenance and part wear. Operating any off-road machine while, or after, consuming alcohol and/or drugs increases risk of bodily harm or death. No warranty or representation is made as to this product's ability to protect user from severe injury or death. SuperATV® urges operators and occupants to wear a helmet and appropriate riding gear at all times.

By purchasing and installing SuperATV® products, user agrees that should damages occur, SuperATV® will not be held responsible for loss of time, use, labor fees, replacement parts, or freight charges. SuperATV®, nor any 3rd party, will not be held responsible for any direct, indirect, incidental, special, or consequential damages that result from any product purchased from SuperATV®. The total liability of seller to user for all damages, losses, and causes of action, if any, shall not exceed the total purchase price paid for the product that gave rise to the claim.

SuperATV® will warranty only parts provided by SuperATV®. Any damage or problems with OEM housings, bearings, seals, or other manufacturers' products will not be covered by SuperATV®. SuperATV® parts and products are not warranted if item was not installed properly, misused, or modified.

Installing, adding, modifying, or fabricating any factory or aftermarket product to your ATV/UTV may violate certain local, state, and federal laws. Be advised that laws vary depending on town, city, county, state, etc. Use of certain products on public streets, roads, or highways may be in violation law. The Buyer is solely and exclusively legally and personally responsible for any violation of the law by the installation or use of the product. You must abide by all local, state, and federal laws, including but not limited to vehicle safety, traffic laws, and ordinances. It is your responsibility to know the laws and how they apply to you.

The Buyer is responsible to fully understand the capability and limitations of his/her vehicle according to manufacturer specifications, warnings and instructions and agrees to hold SuperATV® harmless from any damage resulting from failure to adhere to such specifications, warnings and/ or instructions. The Buyer is also responsible to obey all applicable federal, state, and local laws and ordinances when operating his/her vehicle while using this product, and the Buyer agrees to hold SuperATV® harmless from any violation thereof.

Front Do not tighten hardware completely unless noted. Keep all components removed from machine.

1. Raise Front of machine off ground, secure with jack stands.
 - Remove Wheels.
 - Remove Brake Calipers from Spindles and hang out of way.
 - Remove Tie Rods.
 - Unbolt Shocks from Upper A-Arms.
 - Remove Spindles and Axles.
 - Remove Front Sway Bar; *Sway Bar will not be reinstalled.*
2. Remove stock Upper and Lower A-Arms from Frame.
3. Transfer stock Ball Joints and Bushings, or install SuperATV Poly Bushing Kit AAB-P-RZR, into A-Arms (A-D). See Fig. 1.
 - Install Grease Fittings (H) into A-Arms (A-D). See Fig. 1.
4. Install Differential Spacer. See Page 7.
5. Install *optional* Steering Stop Kit to Rack and Pinion. Kit prevents over extension of Axles, when reversing under hard throttle, by limiting steering range. See Page 7.
6. Install provided Tie Rods. See page 8. Use provided Tie Rod Kit Hardware when reinstalling to Spindles:

**Reinstall to *bottom* side of Spindle Steering Arm for RZR 800 2 seater and RZR S 800 2 seater.
Reinstall to *top* side for RZR 4 800 4 seater.**

7. Install Axles.
8. Install A-Arms (A-D) to machine with stock hardware. SuperATV recommends using Loc-Tite on Nuts when installing. See Fig. 2.
9. Remove Passenger and Driver side Brake Lines and install Passenger side onto Driver side. Install Brake Line, Front (G) to Passenger side. See Brake Line Assembly Detail.
10. Reinstall necessary components with stock hardware; tighten completely.
11. Ensure no binding can occur and secure Brake Lines with provided Brake Line Clips (E) and M5-.8 x 13mm Lg. HHCS. See Fig. 3.

If kit includes Shock Brackets, go to "Brackets Installation", pages 14 - 16.

stock Ball Joint

Fig. 1

Install Grease Fittings (H) into A-Arms (A-D)

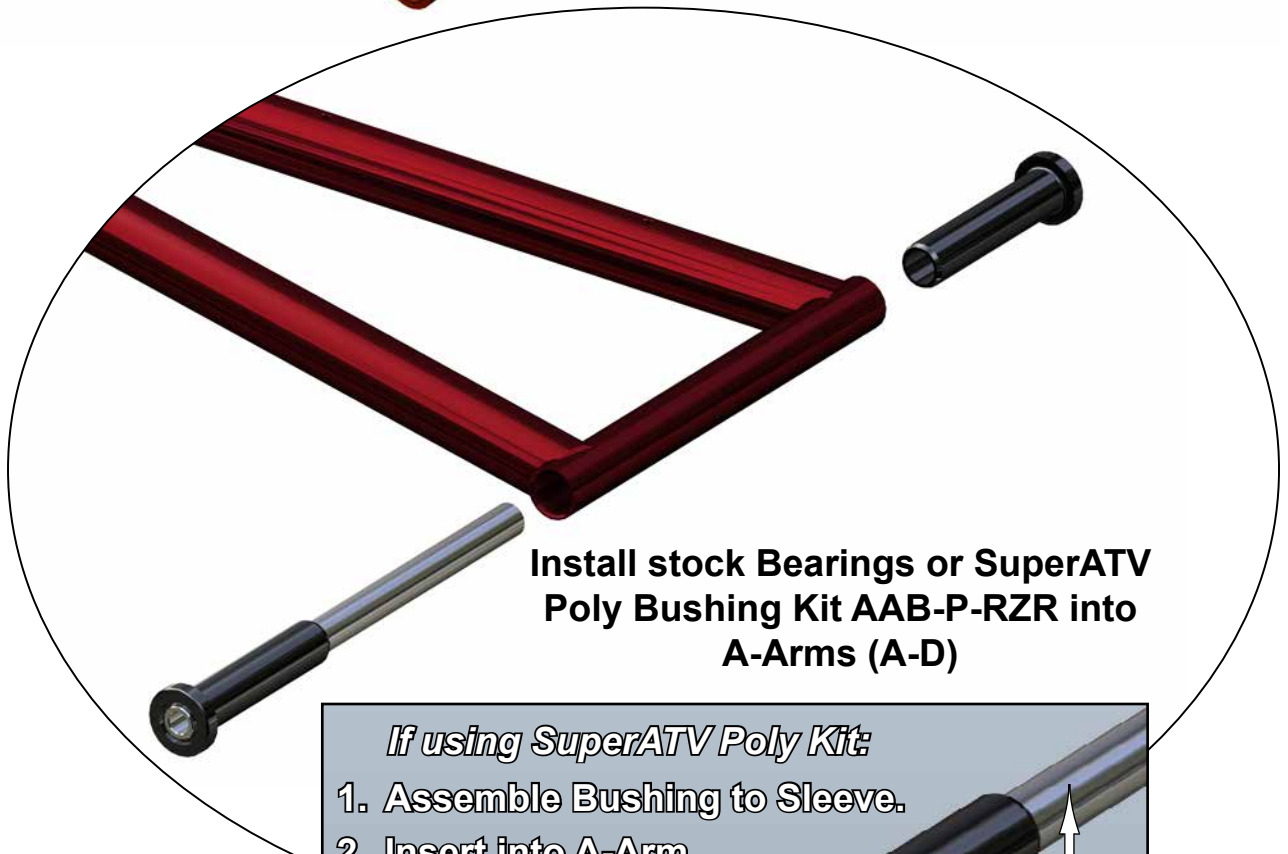
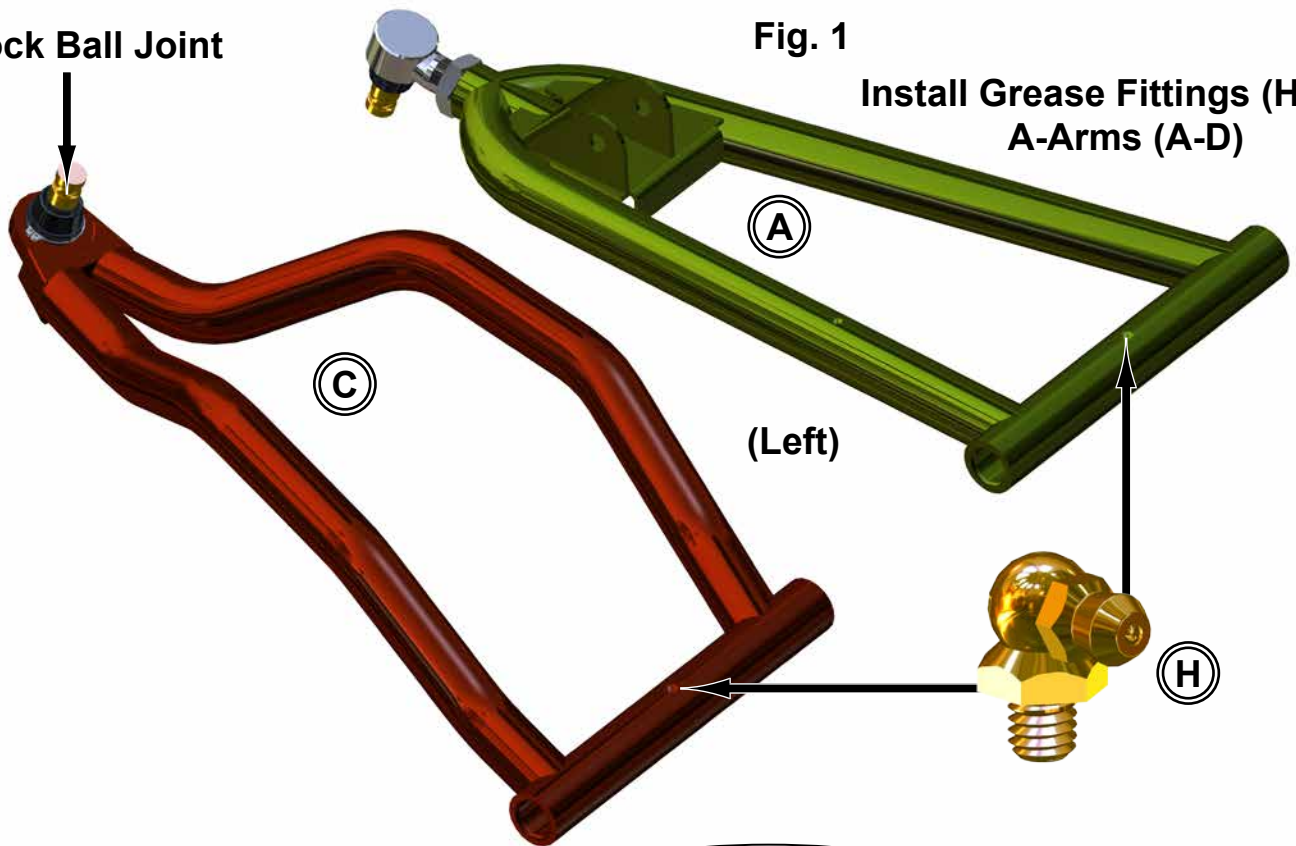

Install stock Bearings or SuperATV Poly Bushing Kit AAB-P-RZR into A-Arms (A-D)

If using SuperATV Poly Kit:

1. Assemble Bushing to Sleeve.
2. Insert into A-Arm.
3. Install Bushing.

Bushing →

Sleeve ↑

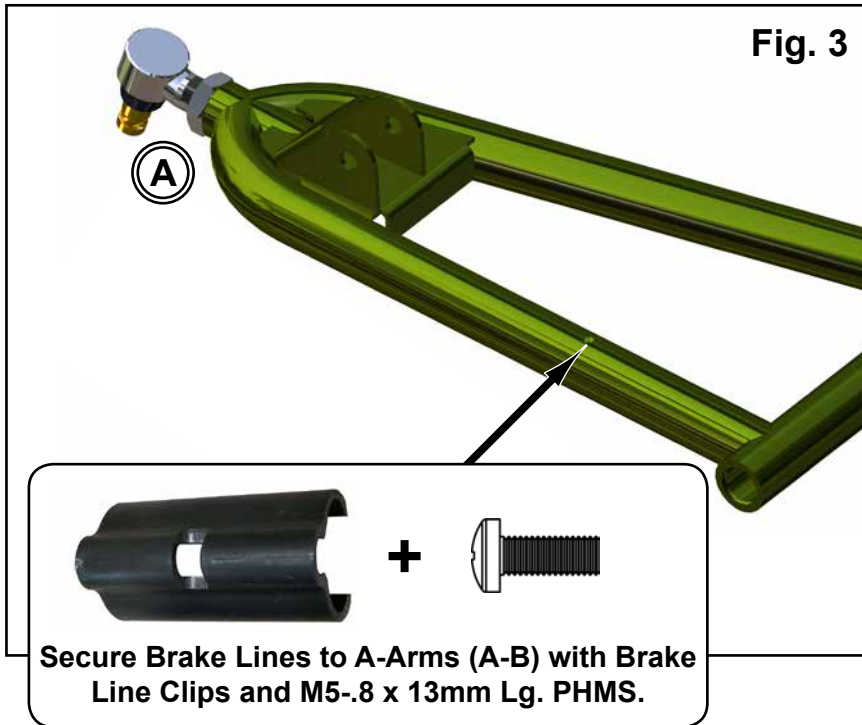

Install Spacer only if using aftermarket Shocks

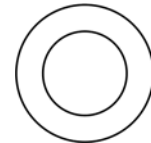

Ø18OD x Ø13ID x 5mm THK

Set Pivot Blocks to dimension shown:

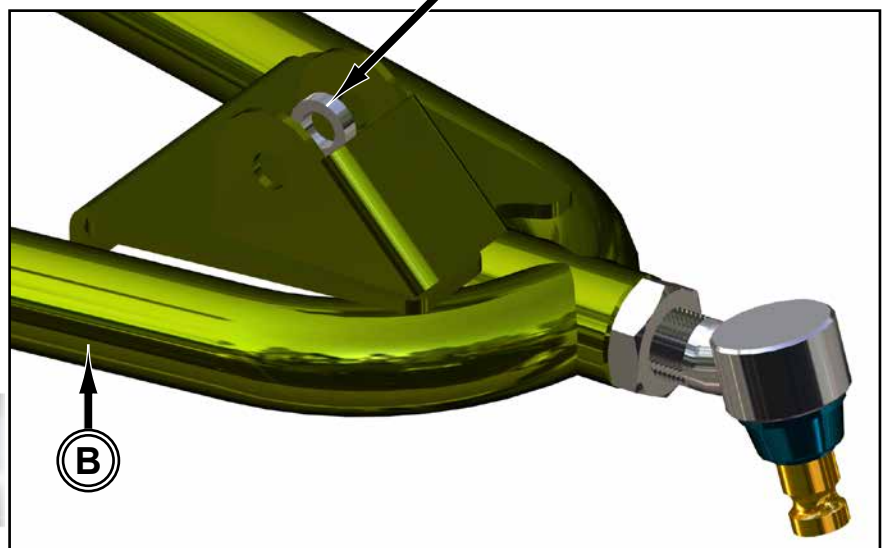
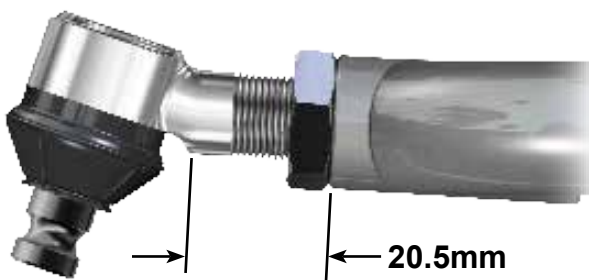

Differential Spacer Installation

1. Remove (2) forward most bolts holding Front Differential to Frame. Loosen remaining (2). See Fig. 1.
 2. Pry Differential up and slide Differential Spacer underneath Differential as shown in Fig. 2.
- Determine correct hardware, see "Differential Spacer Kit" below, and secure Differential Spacer. Tighten hardware completely.

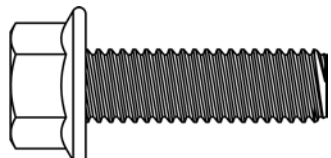
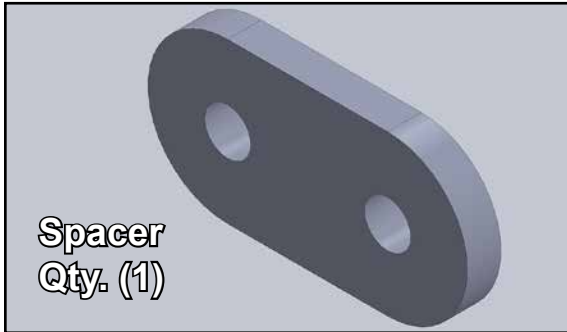

3/8" x 1-1/4" Lg. FHCS
Qty. (2)

2010 and Older

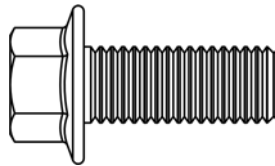

M10 x 25mm Lg. FHCS
Qty. (2)

2011 and Newer

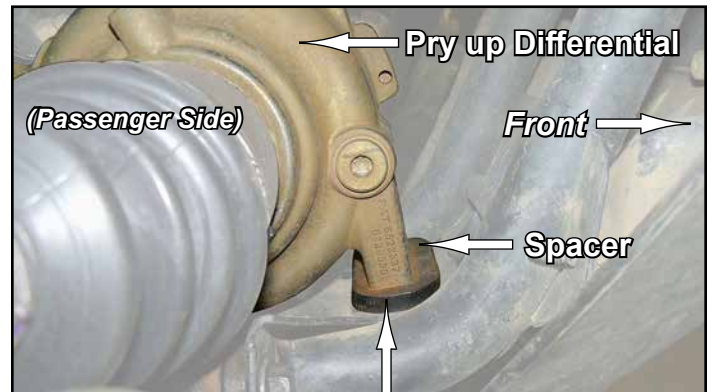
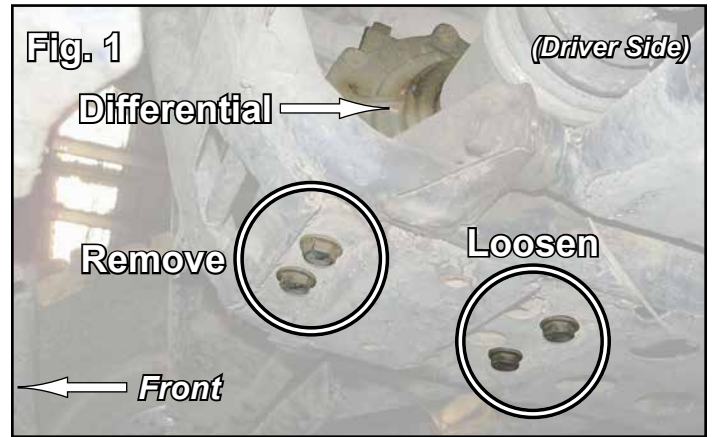

Fig. 2 Insert Spacer underneath
Bolts should thread easily into Differential. If resistance occurs, STOP! Use other bolts included with kit.

If installing Steering Stop, install Tie Rods *before* reinstalling Boots and Wire Ties

NOTE: Not included with zero offset arms.

Steering Stop Installation

(Rack and Pinion shown off machine for clarity)

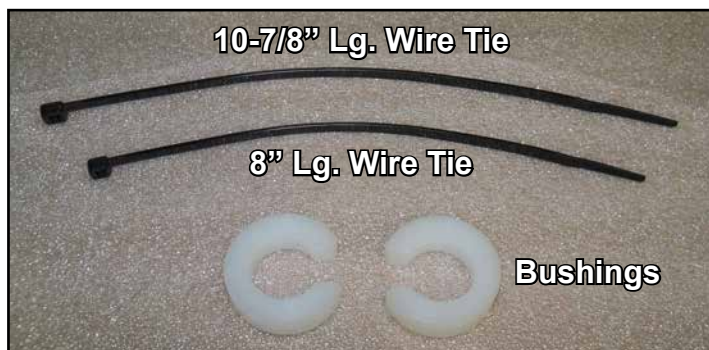

Note: Driver Side installation is shown.

1. Unclamp and slide Boot away from Steering Gear Box.
 2. Install Bushings onto shaft. See Fig. 1.
 3. Reinstall Boot with 10-7/8" Lg. Wire Tie. See Fig. 1a.
- Repeat steps for opposite side.



Tie Rod Installation (Rack and Pinion shown off machine for clarity)

1. Install Ball and Socket to Rack and Pinion. **Use Loctite**. See Fig. 1.
2. Remove, and keep, Jam Nut from Ball and Socket. See Fig. 1.
3. Reinstall stock, or supplied, Boot as shown in Fig. 2. Use a lubricant to ease installation.
4. Reinstall Jam Nut and install Tie Rod to Ball and Socket. See Fig. 2.
5. Secure Boot with supplied Wire Ties. See Fig. 2.
6. Install supplied Tie Rod End to Tie Rod.
7. Repeat steps for opposite side.

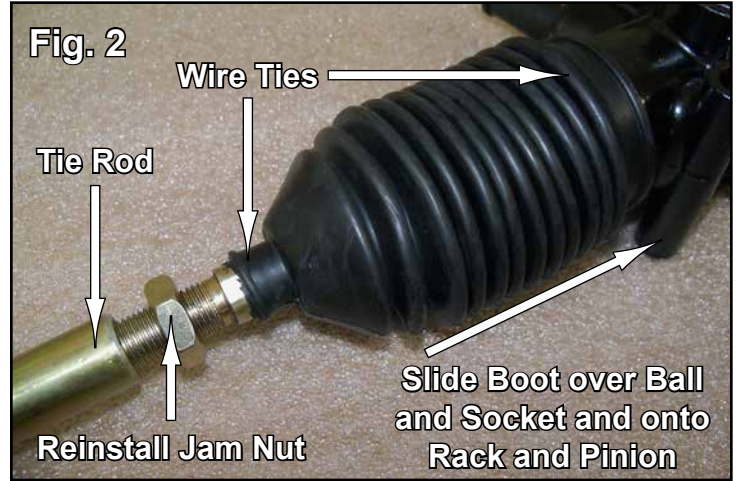
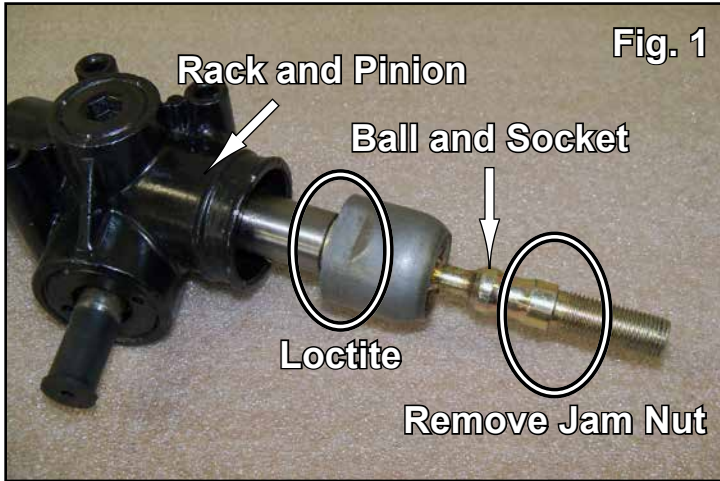

**Depending on application, Straight or Z-Bend Tie Rods will be used.*

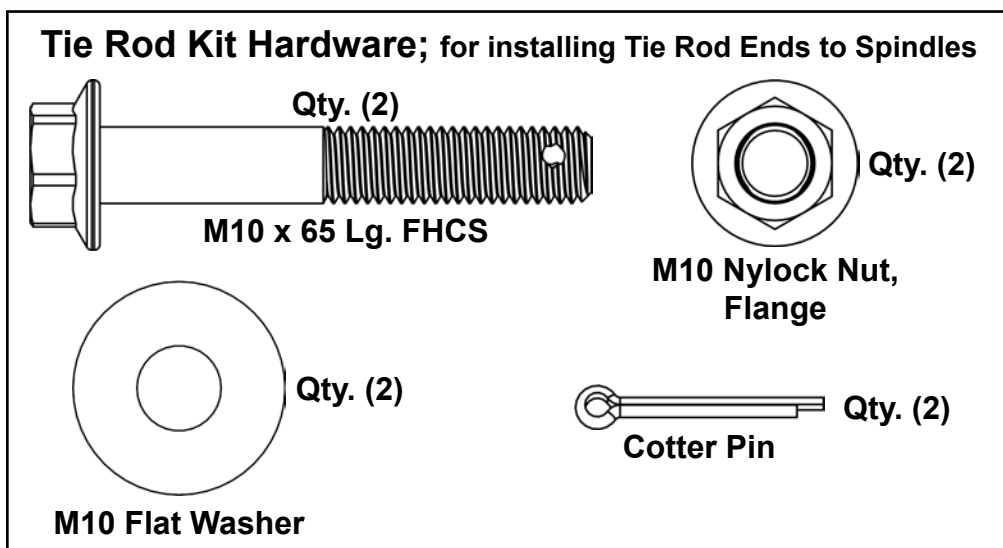
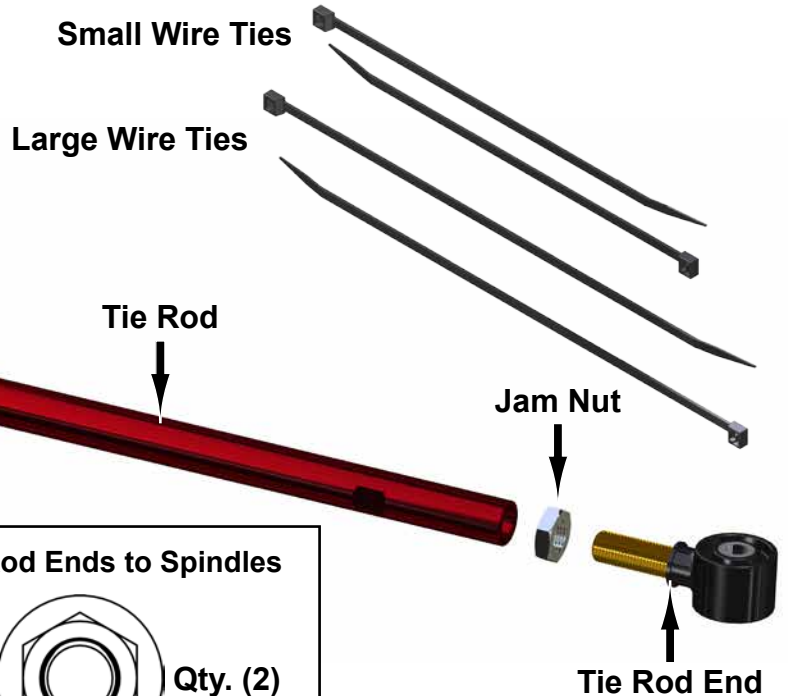
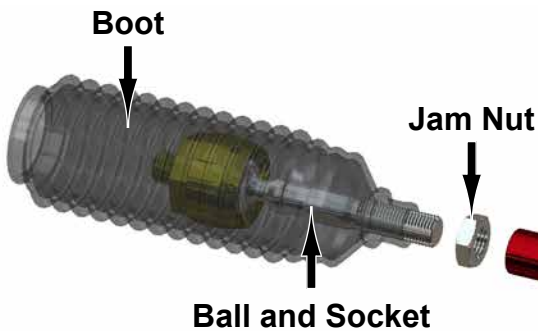

Rear Do not tighten hardware completely unless noted. Keep all components removed from machine.

1. Raise Rear of machine off ground, secure with jack stands.
 - Remove Wheels.
 - Remove Brake Calipers from Spindles and hang out of way. See Fig. 4.
 - Unbolt Sway Bar links and Shocks from Lower A-Arms. See Fig. 4.
 - Remove Spindles and Axles. See Fig. 4.
2. Remove stock Upper and Lower A-Arms from Frame. See Fig. 4.
3. Remove Sway Bar and components shown in Fig. 4a.
4. Transfer stock Bushings, or install SuperATV Poly Bushing Kit AAB-P-RZR, into A-Arms (K-N). See Fig. 5.
 - Install Grease Fittings (H) into A-Arms (K-N). See Fig. 5.
5. Install Axles.
6. Install A-Arms (K-N) to machine with stock hardware. SuperATV recommends using Loc-Tite on Nuts when installing. See Fig. 6.
7. Remove Passenger and Driver side Brake Lines and install Passenger side onto Driver side. Install Brake Line, Rear (F) to Passenger side. See Brake Line Detail, Rear.
8. Install provided Sway Bar. See pages 12 - 13.
9. Reinstall necessary components with stock hardware; tighten completely. See Fig. 7.
10. Ensure no binding can occur, and secure Brake Lines with provided Brake Line Clips (E) and M5-.8 x 13mm Lg. HHCS. See Fig. 7.

If kit includes Shock Brackets, go to "Brackets Installation", pages 14 - 16.

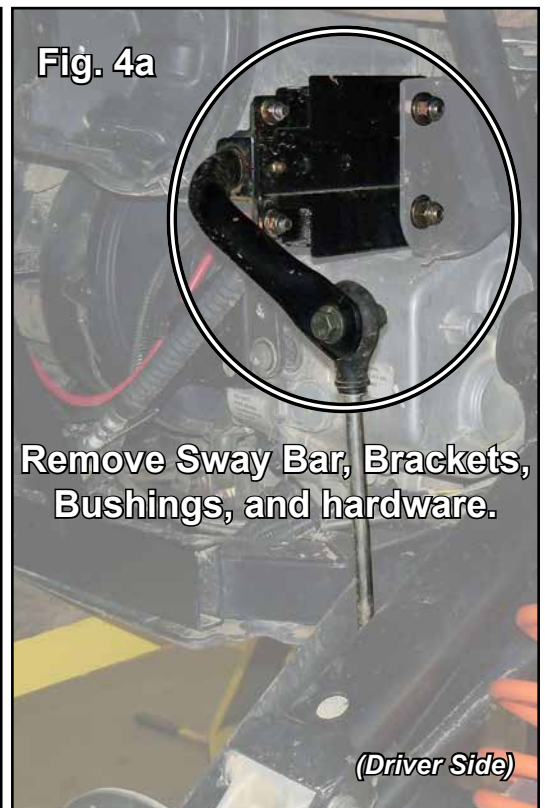
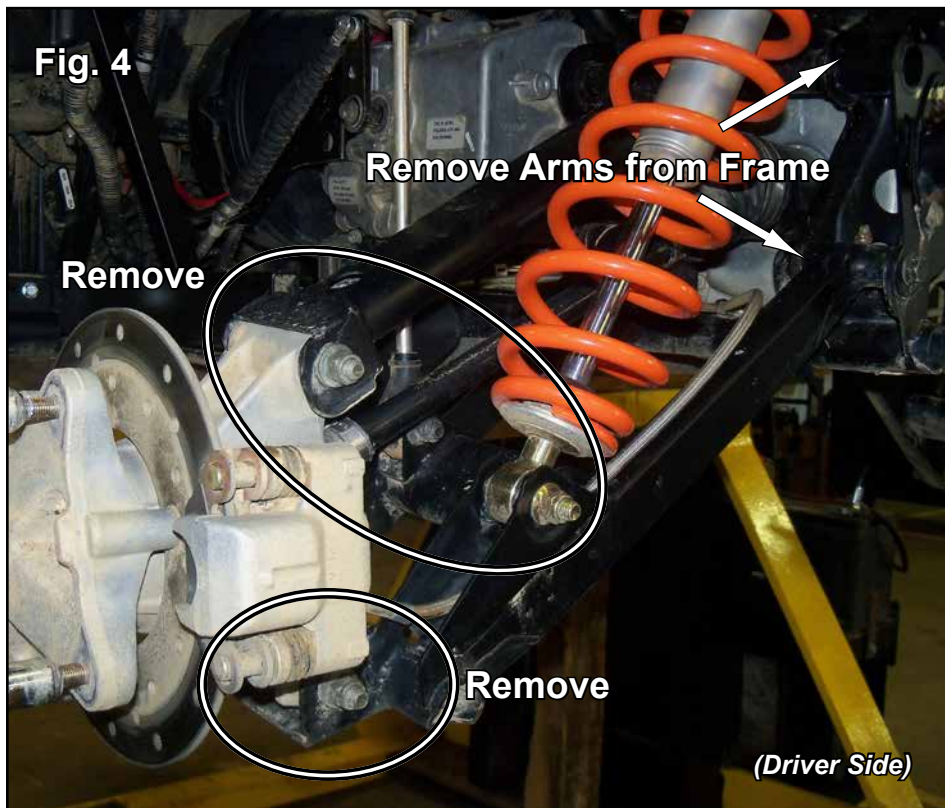

(illustrations continue on following page)

Fig. 5

Install stock Bearings or SuperATV Poly Bushing Kit AAB-P-RZR into A-Arms (K-N)

If using SuperATV Poly Kit:

1. Assemble Bushing to Sleeve.
2. Insert into A-Arm.
3. Install Bushing.

Sleeve

Bushing

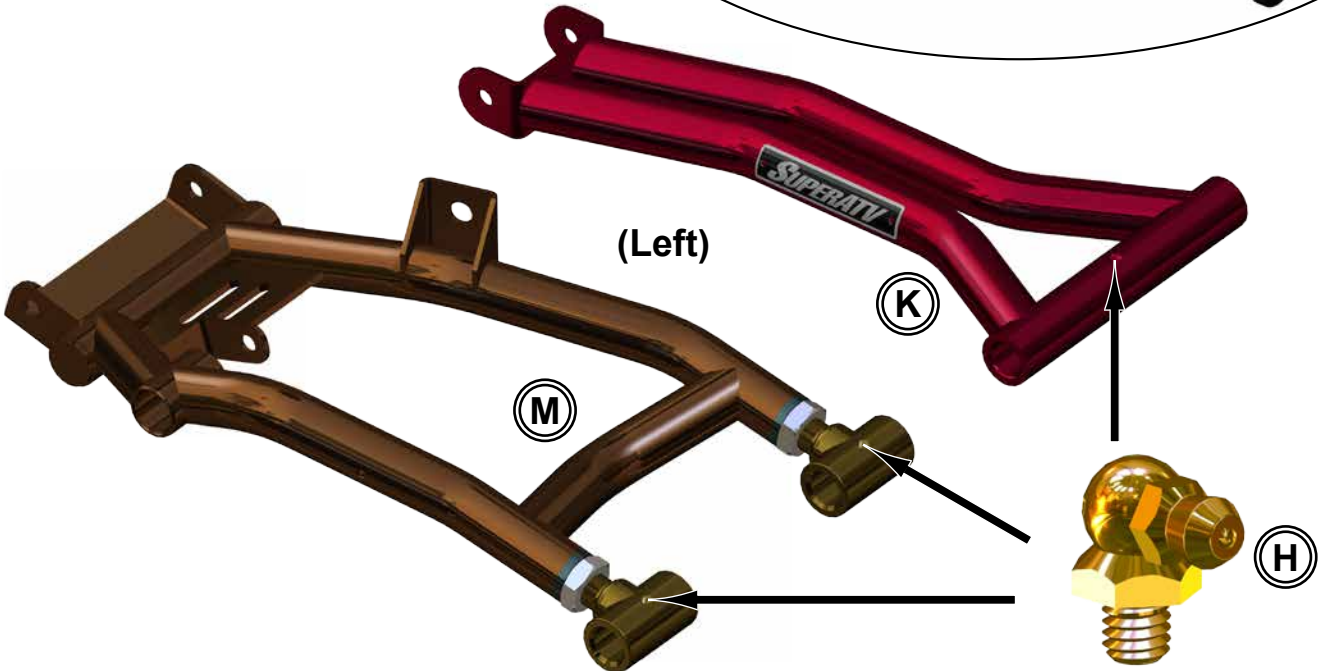

Install Grease Fittings (H) into A-Arms (K-N)

If using SuperATV Poly Kit:

1. Assemble Bushing to Sleeve.
2. Insert into A-Arm.
3. Install Bushing.

Bushing

Sleeve

Set Pivot Blocks to dimension shown:
(end of A-Arm to face of Pivot Block)

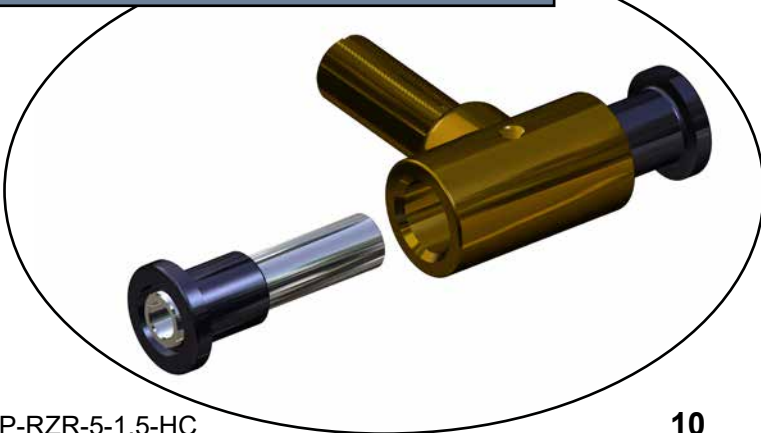
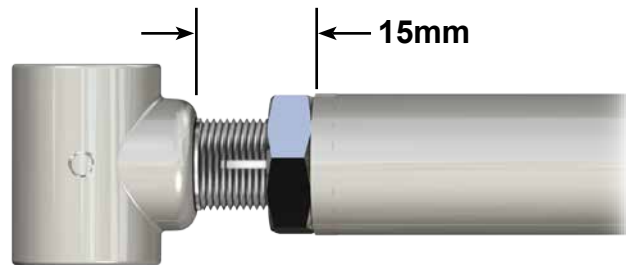

(illustrations continue on following page)

(illustrations continued)

Install A-Arms (K-N) to Frame with stock hardware Fig. 6

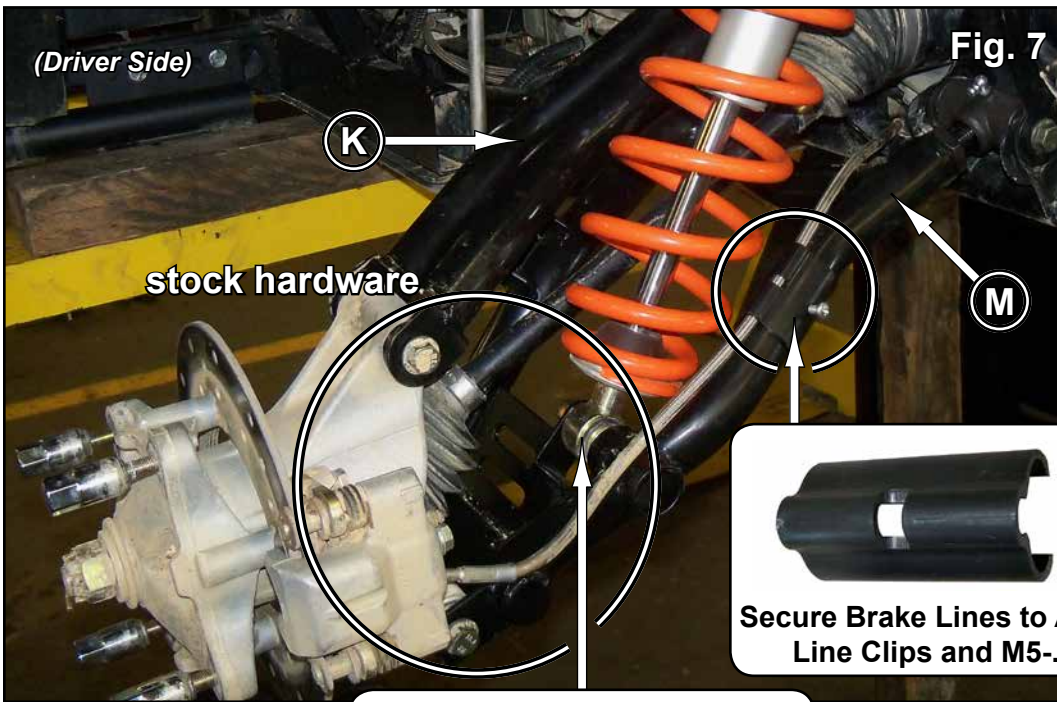
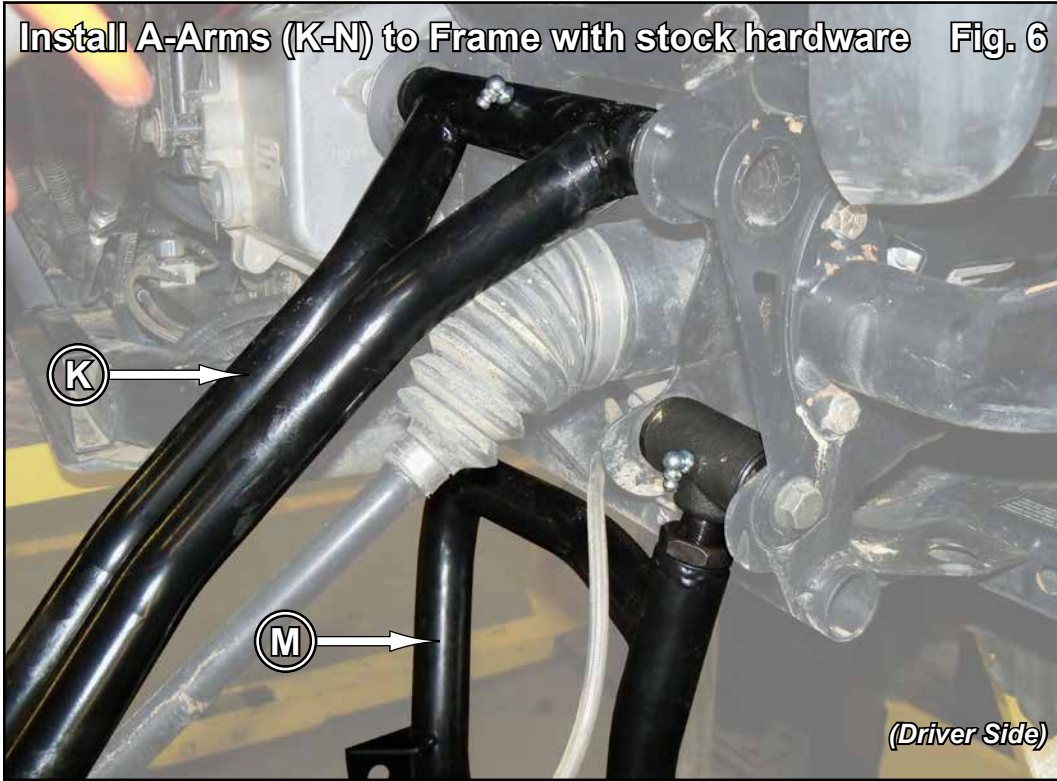

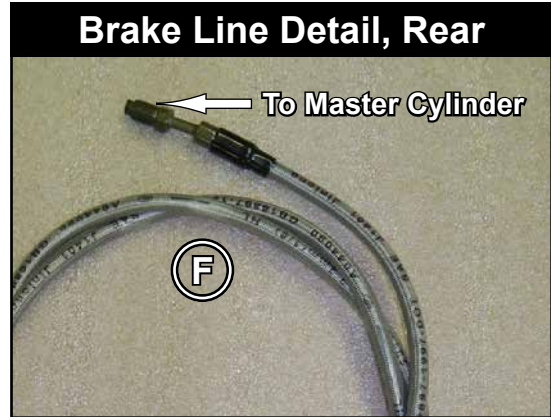

Install Spacer if using
aftermarket Shocks.
Ø18OD x Ø13ID x 5mm THK

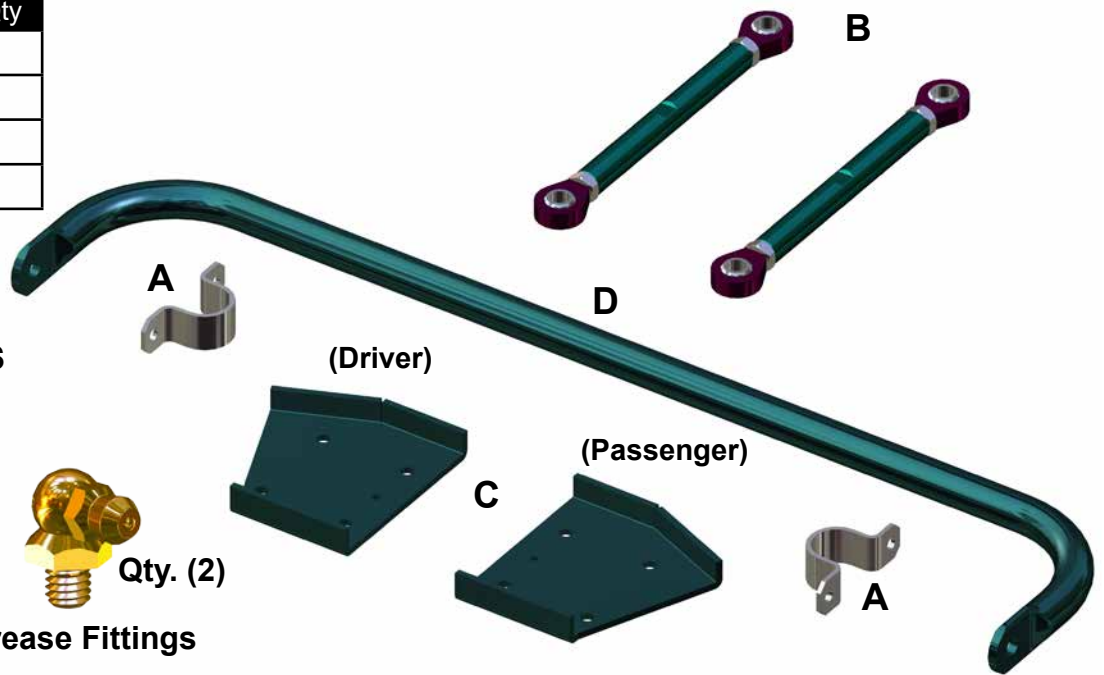

Sway Bar Installation *Do not tighten hardware completely unless noted.*

Item	Description	Qty
A	Sway Bar Clamps	2
B	Sway Bar Links	2
C	Brackets	2
D	Sway Bar	1



1. Install Grease Fittings into Brackets (C).
2. Install Brackets (C) to Frame with M8-1.25 x 25mm Lg. HHCS and M8-1.25 Nylock Nuts. Reuse stock Brackets and Bushings. See Fig. 1.
3. Install Sway Bar (D) and Sway Bar Clamps (A) to Brackets (C). Secure with M8-1.25 x 25mm Lg. HHCS (B) and M8-1.25 Nylock Nuts (D). Reuse stock Bushings. See Figs. 2 - 2a.

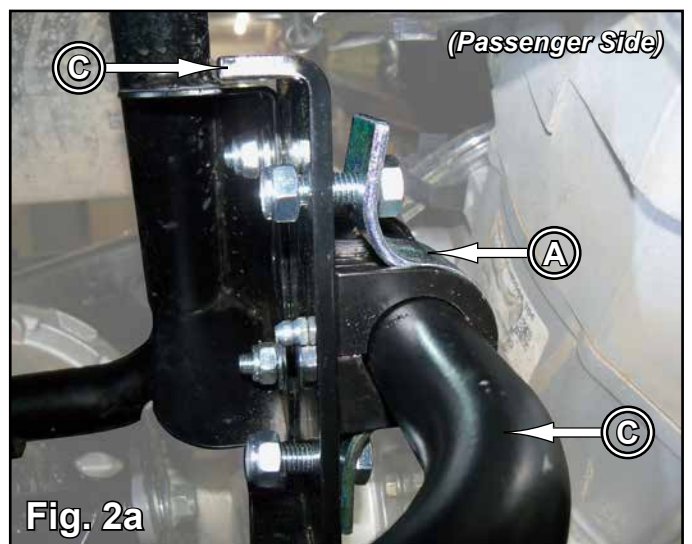
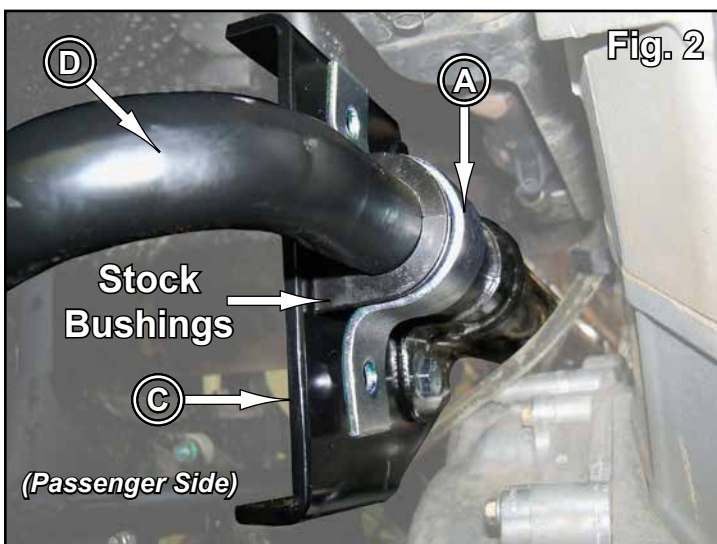
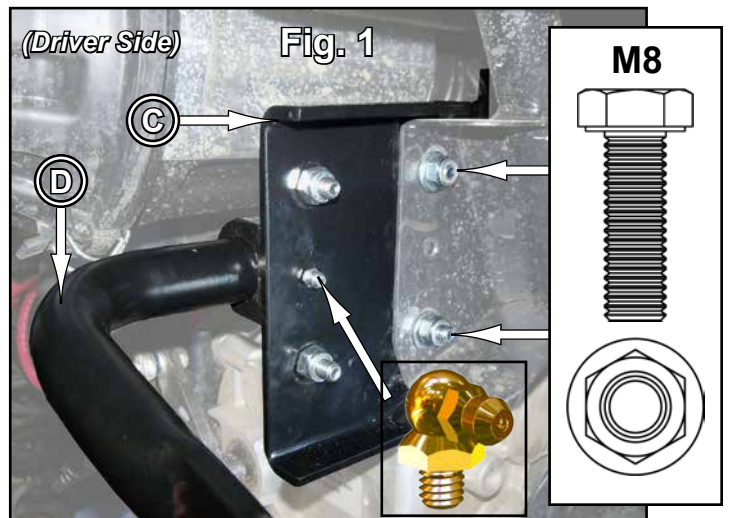

(Sway Bar illustrations continue on following page)

Sway Bar Installation continued *Do not tighten hardware completely unless noted.*

Install Sway Bar Links to Sway Bar and Lower A-Arms with provided 1/2" x 1-3/4" Lg. HHCS and 1/2" Nylock Nuts. Ø18mmOD x Ø13mmID x 9.5 mm THK Spacer installs between A-Arm and Sway Bar Link. Tighten all hardware completely.

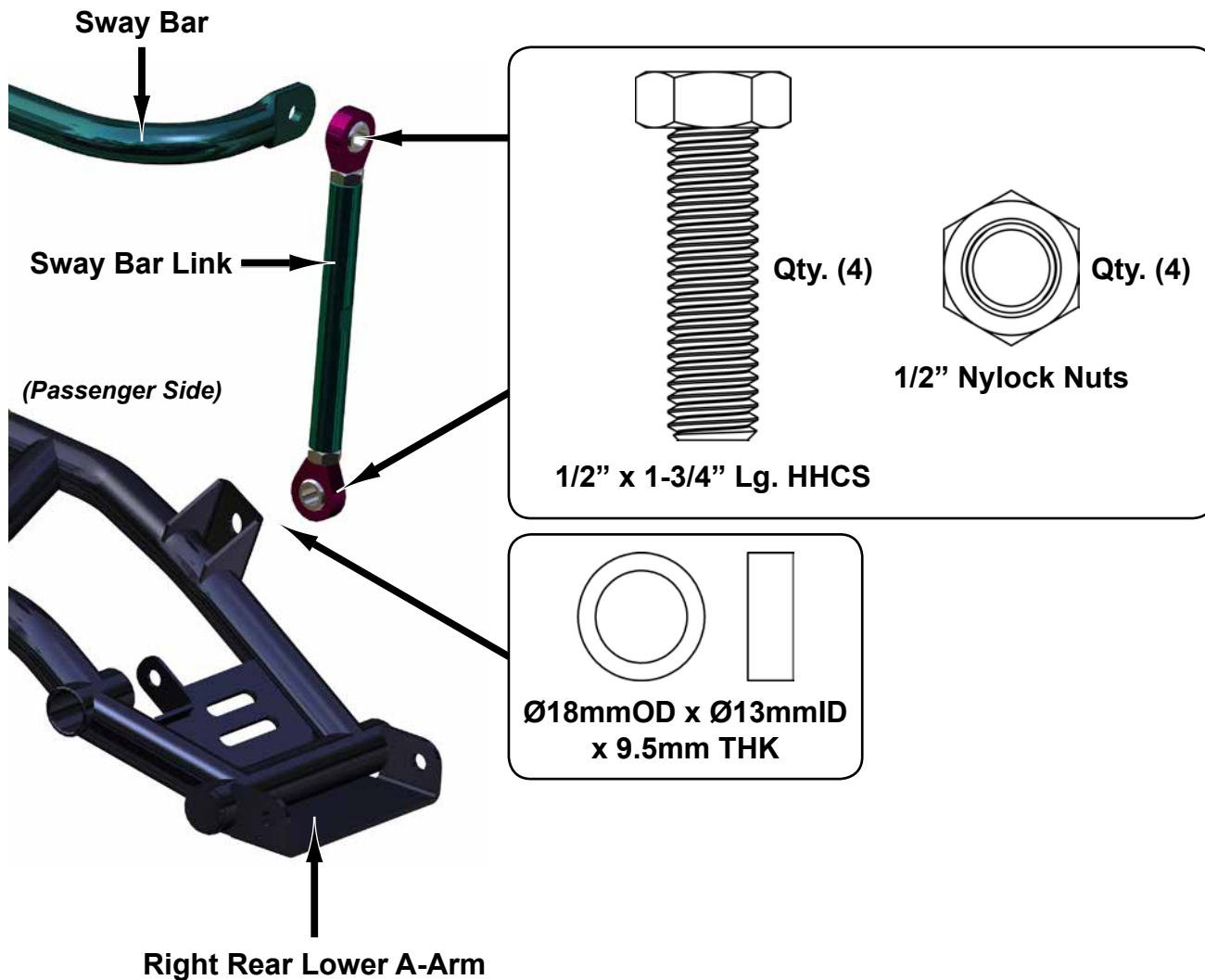

**If kit includes Shock Brackets, continue to
"Brackets Installation", pages 14 - 16.**

LONG TRAVEL KIT



Front Long Travel Bracket

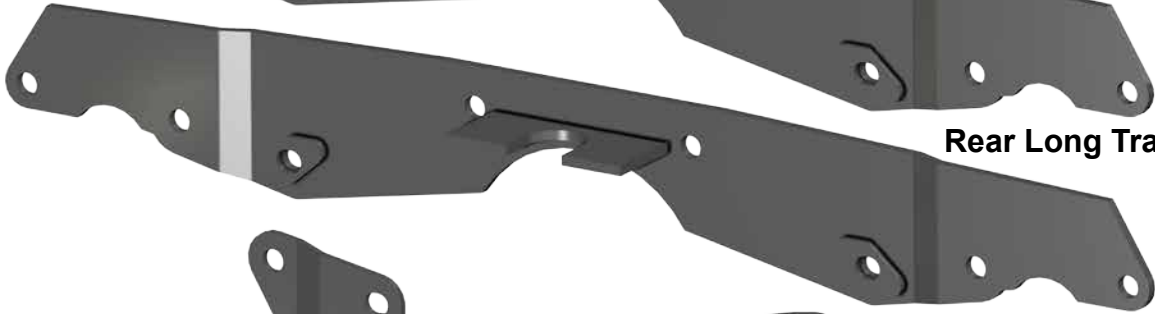

Rear Long Travel Brackets



Stabilizer Bars

LIFT KIT



Front Lift Bracket

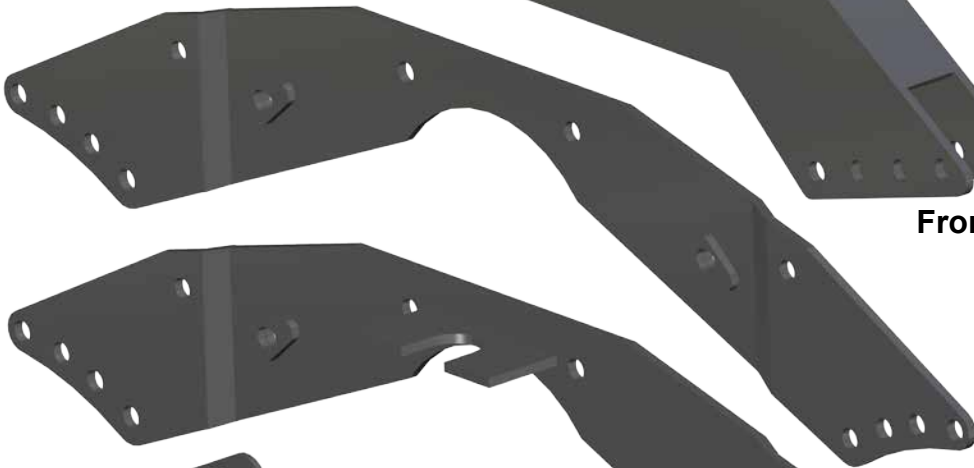

Rear Lift Brackets



Stabilizer Bars

Lift Brackets installation shown:

Do not tighten hardware completely unless noted. Keep all components removed from machine.

FRONT Remove Shocks from Frame.

1. Install Front Bracket (A) to Frame. Secure with M10-1.50 x 60mm Lg. HHCS and M10-1.50 Nylock Nuts. See Figs. 1 - 2.
 - Spacers, Short install between Front Bracket. See Fig. 2.
2. Determine lift and reinstall Shocks to Front Bracket with stock hardware. See Fig. 2.
 - Tighten all hardware completely.

REAR Remove Shocks from Frame.

1. Install Rear Brackets (Fore and Aft) to Frame.
 - Spacers, Long install between Rear Brackets as shown in Fig. 3.
 - Secure components with hardware shown on following page.
2. Install M10-1.50 x 75mm Lg. HHCS; **do not add M10-1.50 Nylock Nuts**. See Figs. 3 - 4.
3. Remove stock Bolts from stock Bracing. See Fig. 4.
 - Install Stabilizer Bars onto M10-1.50 x 75mm Lg. HHCS and Rear Bracket Aft . Secure with M10-1.50 Nylock Nuts. See Figs. 3 - 4.
4. Reinstall Shocks to Rear Brackets with stock hardware.
 - Tighten all hardware completely.

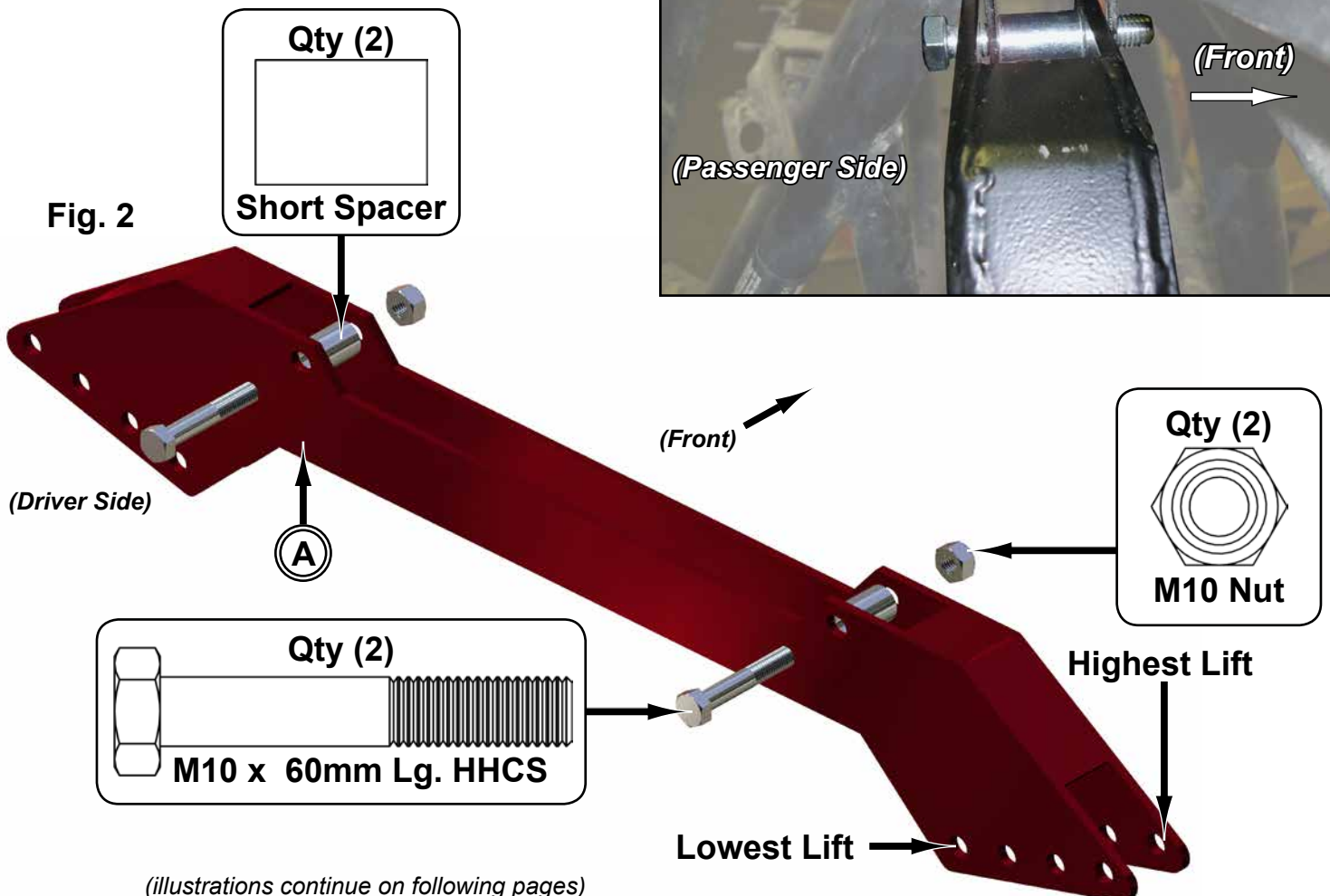
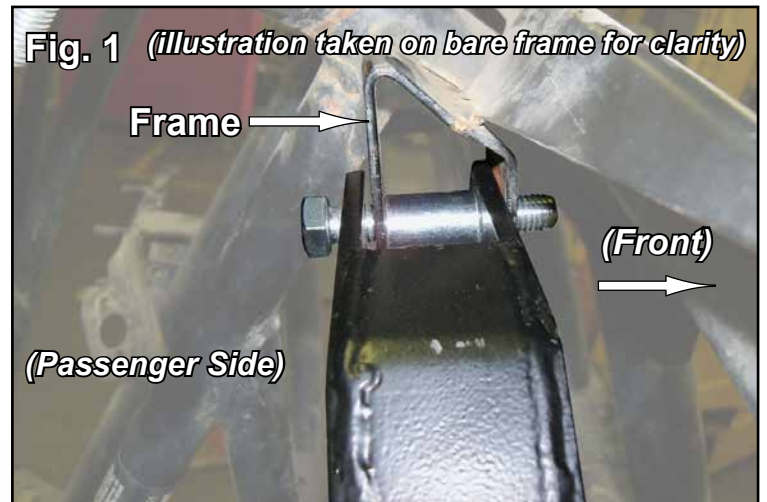

(illustrations continue on following pages)

Fig. 3

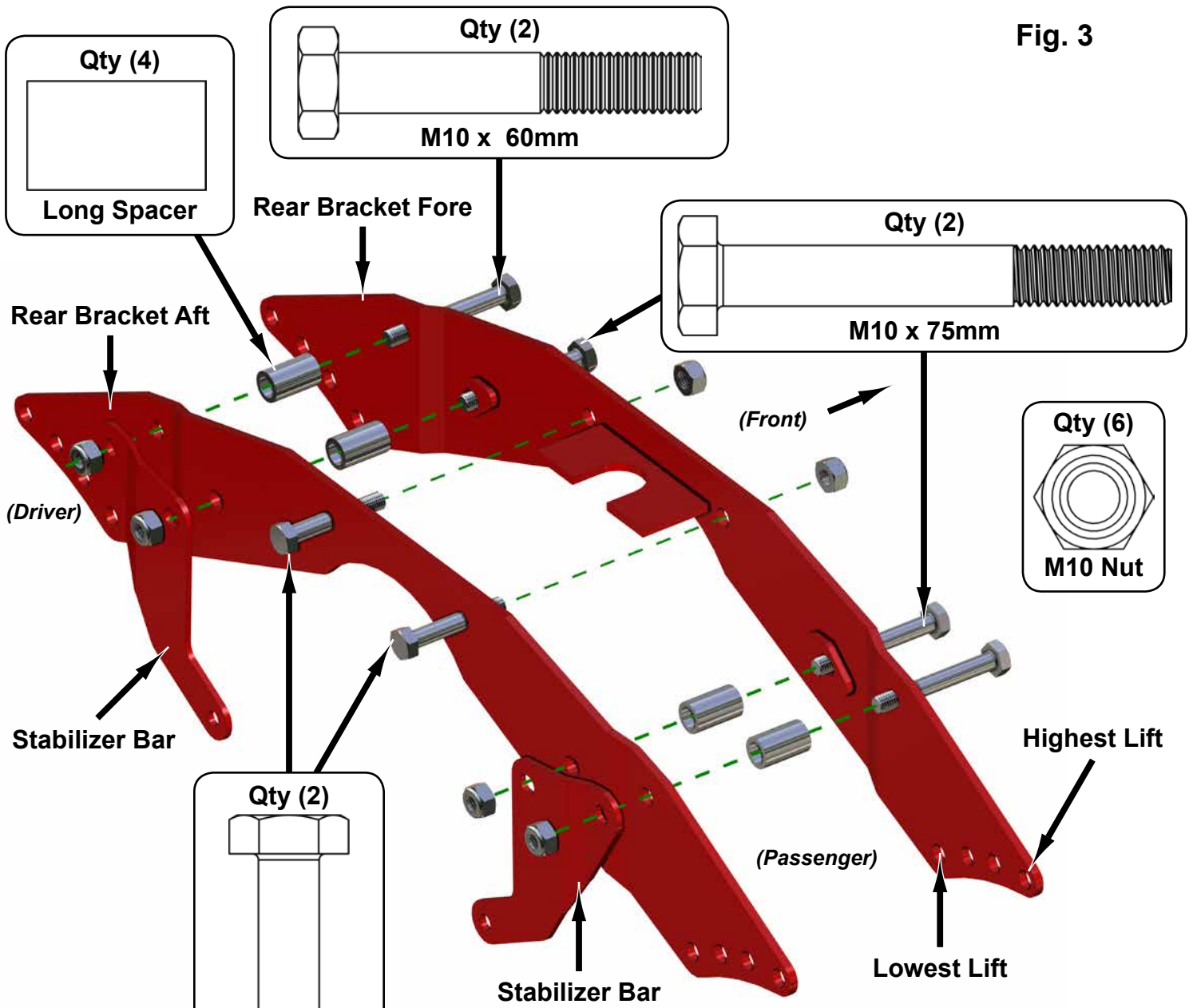
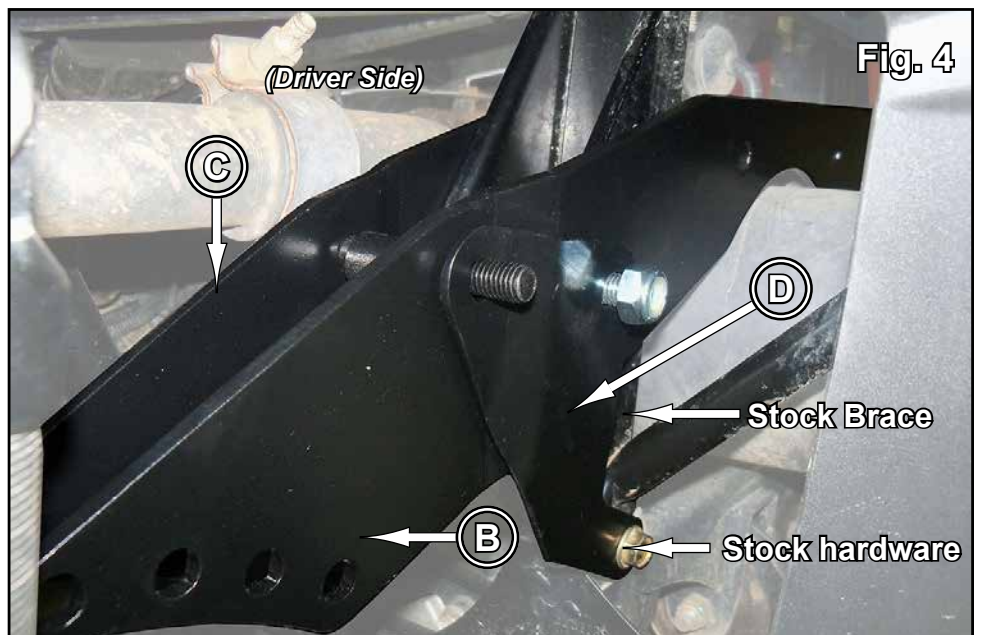

Fig. 4



CAMBER



Perform adjustments in small increments.



Adjustments are to be made after all suspension components have been completely assembled.
Tires must not be in contact with ground when making adjustments.

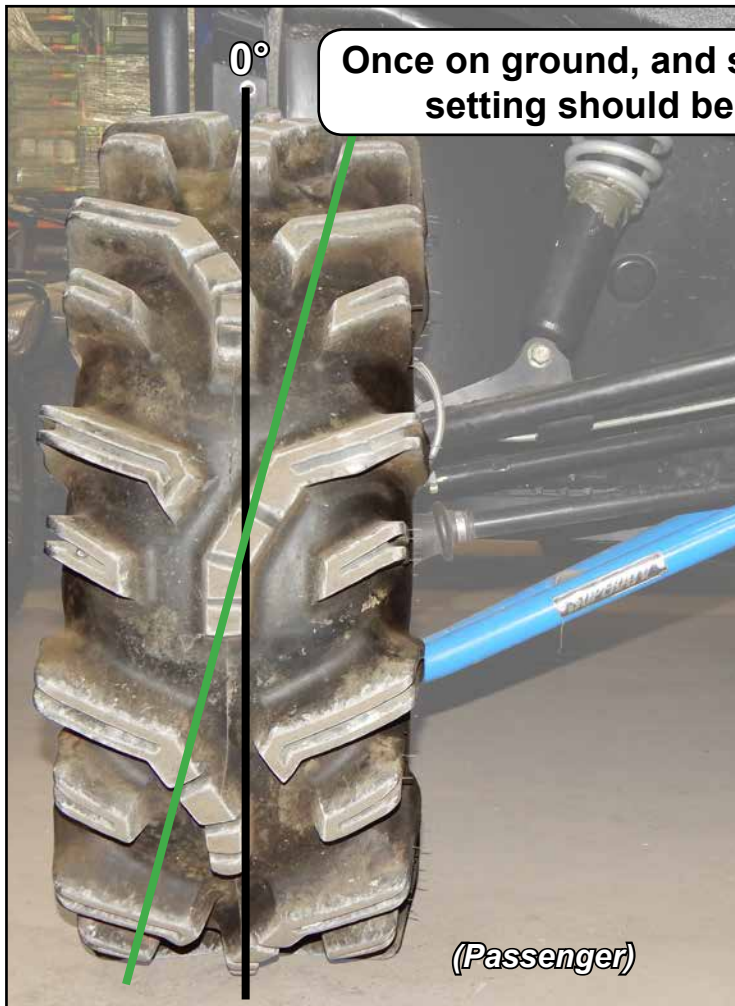

Once on ground, and suspension is settled,
setting should be: negative 1° - 2°

(Passenger)

1. Raise machine so that tires are off ground.
 2. Turn as shown to adjust camber.
 3. Lower machine and settle suspension components by rolling machine back and forth several feet at a time.
 4. Check settings and make small adjustments as needed.
- Each time an adjustment is made, machine must be rolled back and forth to settle suspension components.

A-Arm

Adjust, in or out, to achieve correct setting

