

Item	Description	Item	Description
A	Passenger Upper A-Arm	C	Driver Upper A-Arm
B	Passenger Lower A-Arm	D	Driver Lower A-Arm

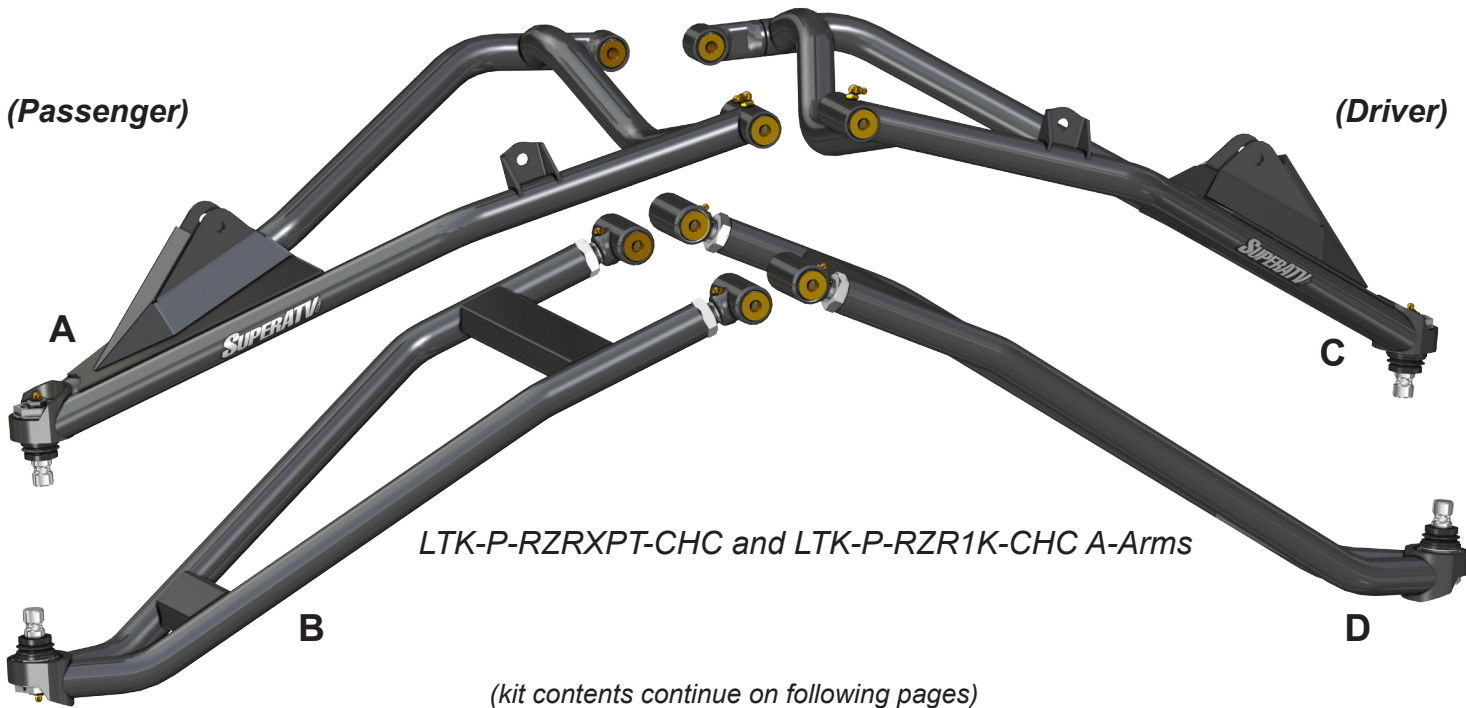

Liability Statement

SuperATV's[®] products are designed to best fit user's ATV/UTV under stock conditions. Adding, modifying, or fabricating any factory or aftermarket parts will void any warranty provided by SuperATV[®] and is not recommended. SuperATV's[®] products could interfere with other aftermarket accessories. If user has aftermarket products on machine, contact SuperATV[®] to verify that they will work together.

Although SuperATV[®] has thousands of satisfied customers, user should be aware that installing lift kits, long travel, or suspension kits, tires, etc. will change the ride of machine and may increase maintenance and part wear. Operating any off-road machine while, or after, consuming alcohol and/or drugs increases risk of bodily harm or death. No warranty or representation is made as to this product's ability to protect user from severe injury or death. SuperATV[®] urges operators and occupants to wear a helmet and appropriate riding gear at all times.

By purchasing and installing SuperATV[®] products, user agrees that should damages occur, SuperATV[®] will not be held responsible for loss of time, use, labor fees, replacement parts, or freight charges. SuperATV[®], nor any 3rd party, will not be held responsible for any direct, indirect, incidental, special, or consequential damages that result from any product purchased from SuperATV[®]. The total liability of seller to user for all damages, losses, and causes of action, if any, shall not exceed the total purchase price paid for the product that gave rise to the claim.

SuperATV[®] will warranty only parts provided by SuperATV[®]. Any damage or problems with OEM housings, bearings, seals, or other manufacturers' products will not be covered by SuperATV[®]. SuperATV[®] parts and products are not warranted if item was not installed properly, misused, or modified.

Installing, adding, modifying, or fabricating any factory or aftermarket product to your ATV/UTV may violate certain local, state, and federal laws. Be advised that laws vary depending on town, city, county, state, etc. Use of certain products on public streets, roads, or highways may be in violation law. The Buyer is solely and exclusively legally and personally responsible for any violation of the law by the installation or use of the product. You must abide by all local, state, and federal laws, including but not limited to vehicle safety, traffic laws, and ordinances. It is your responsibility to know the laws and how they apply to you.

The Buyer is responsible to fully understand the capability and limitations of his/her vehicle according to manufacturer specifications, warnings and instructions and agrees to hold SuperATV[®] harmless from any damage resulting from failure to adhere to such specifications, warnings and/ or instructions. The Buyer is also responsible to obey all applicable federal, state, and local laws and ordinances when operating his/her vehicle while using this product, and the Buyer agrees to hold SuperATV[®] harmless from any violation thereof.

Need help with your installation?

 sales@superatv.com
  www.superatv.com
 1-855-743-3427
  8:00am - 8:00pm EST M-Th
 8:00am - 7:00pm EST Friday
 9:00am - 2:00pm EST Saturday

Read instructions and view illustrations before beginning.

Thank You
For Choosing
SUPERATV.COM[®]

Item	Description
G	Sway Bar Link x 2
J	Driver Trailing Arm
K	Passenger Trailing Arm

(kit contents continued)

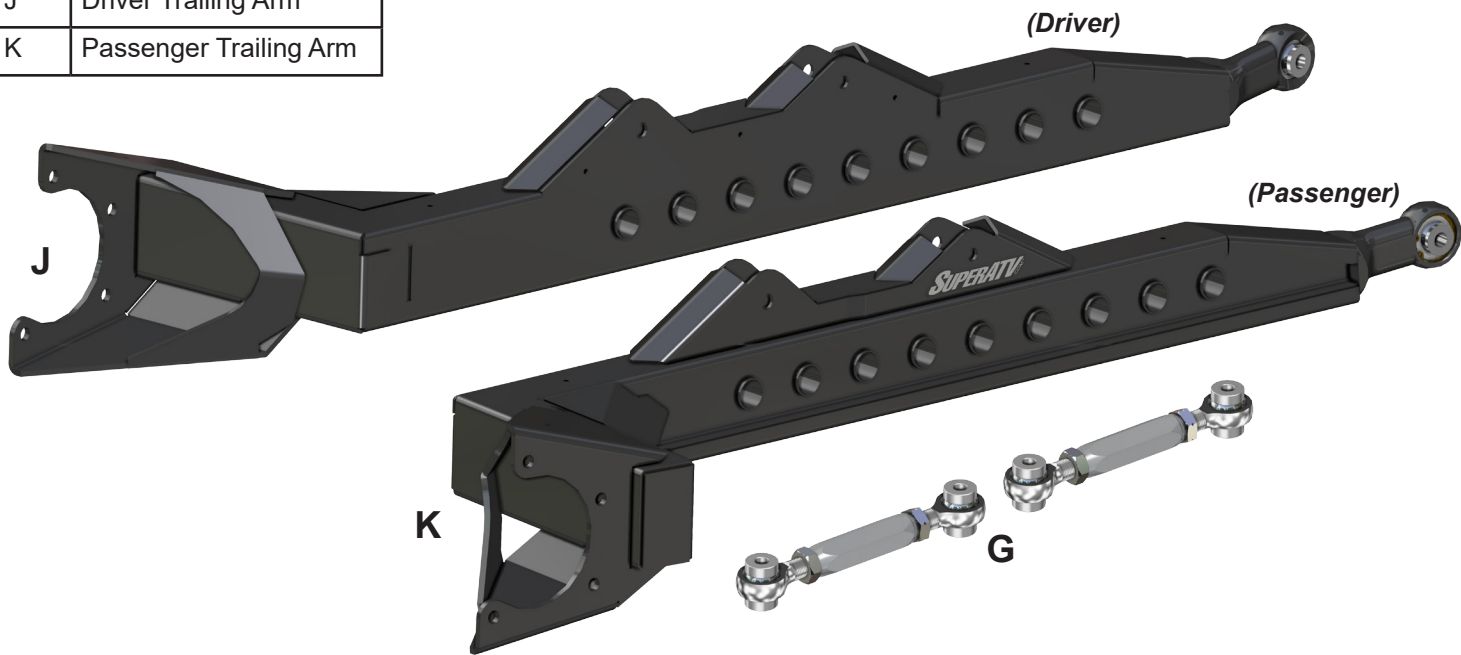

LTK-P-RZRXP-CHC-002 A-Arms

Item	Description	Item	Description
A	Passenger Upper A-Arm	C	Driver Upper A-Arm
B	Passenger Lower A-Arm	D	Driver Lower A-Arm

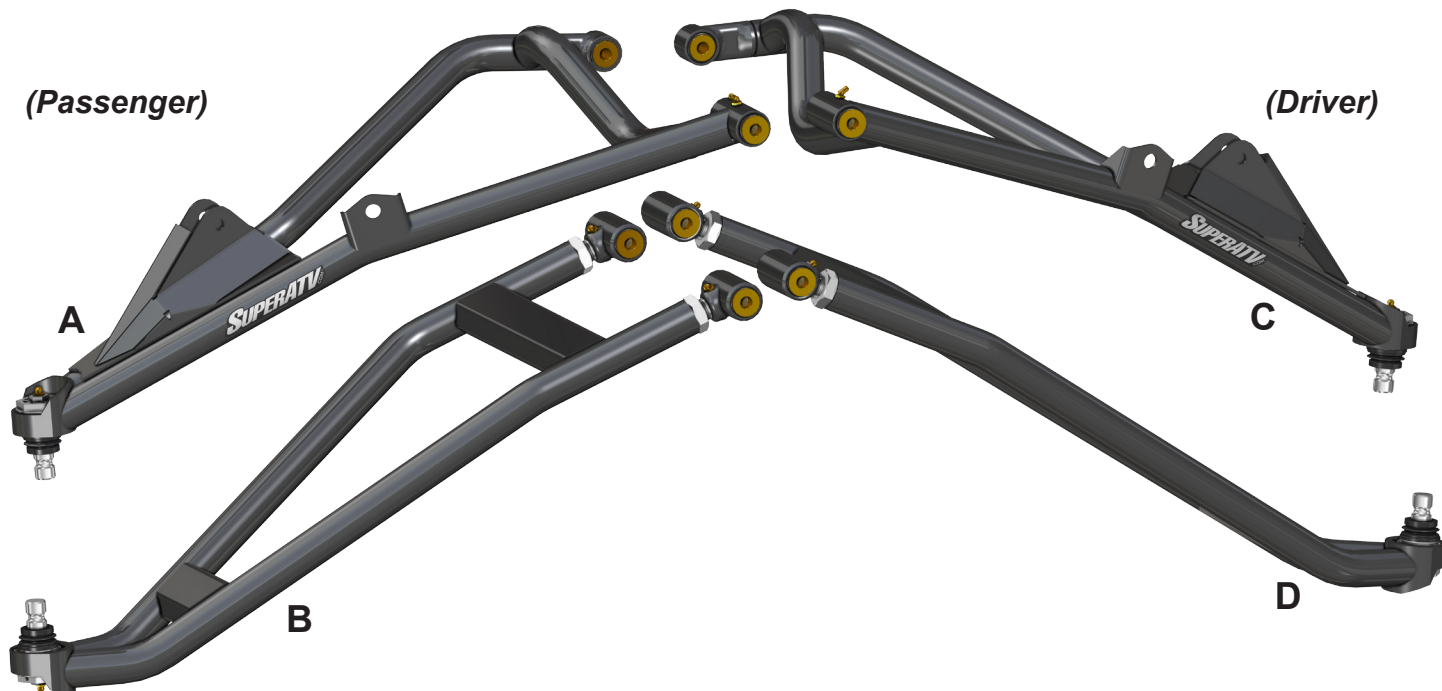

(kit contents continued)

Brake Lines (P)

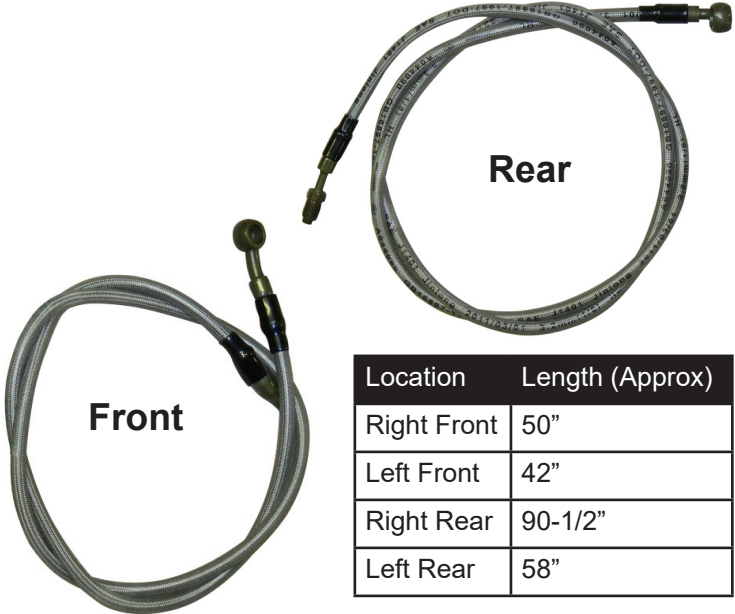

Front

Rear

Location	Length (Approx)
Right Front	50"
Left Front	42"
Right Rear	90-1/2"
Left Rear	58"

Front Brake Lines have same style fittings at each end.



20 each

Brake Line Clip and hardware

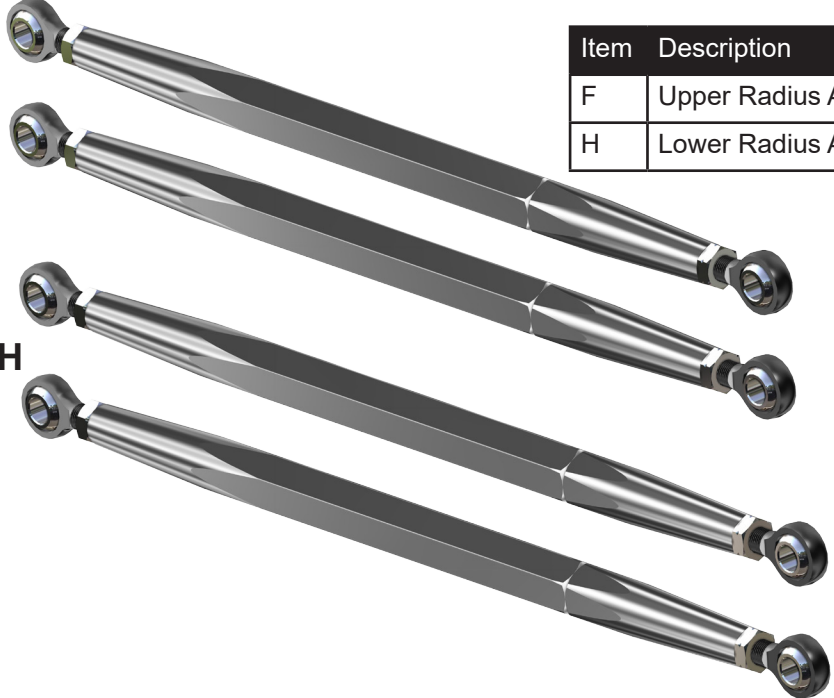

Item	Description
F	Upper Radius Arm x 2
H	Lower Radius Arm x 2

Spring Kit; (2) each

not included or used with *LTK-P-RZRXP-CHC* and *LTK-P-RZRXP-CHC-002* kits



Front components shown must be removed; Keep all components removed from machine.

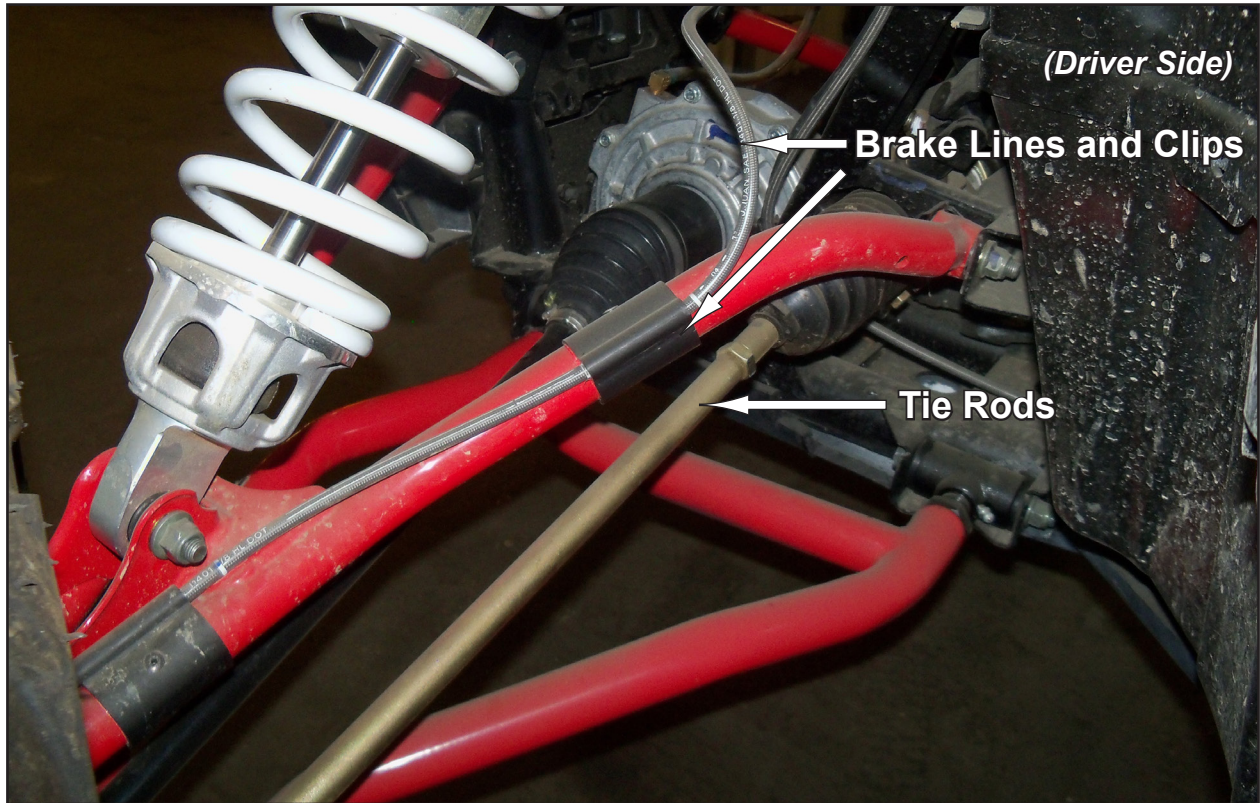
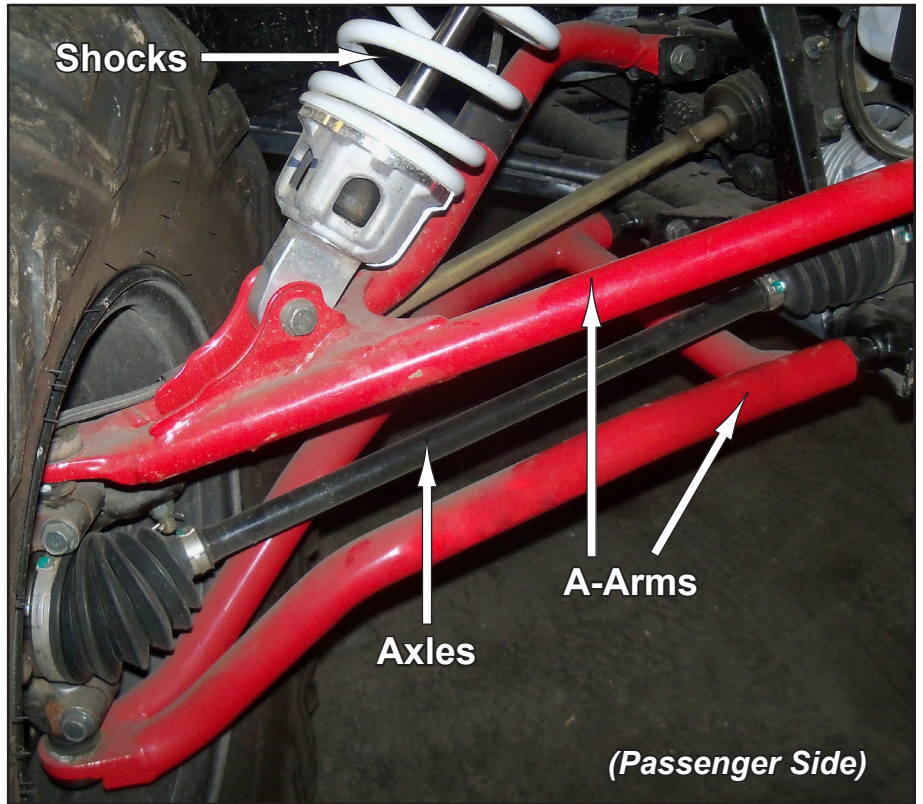
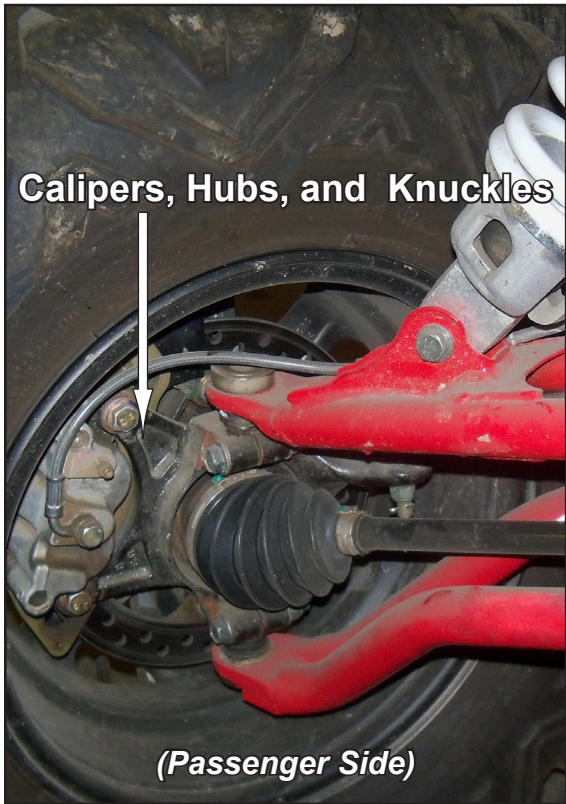

disregard if installing *LTK-P-RZRXP-CHC* or *LTK-P-RZRXP-CHC-002* kits

SuperATV strongly recommends using a spring compressor when removing Springs

Front Springs Prep:

- Replace stock Bottom Springs with supplied SuperATV Spring p/n CS-12x3x250.
- Replace stock Top Springs with supplied SuperATV Spring p/n CS-5x3x50.

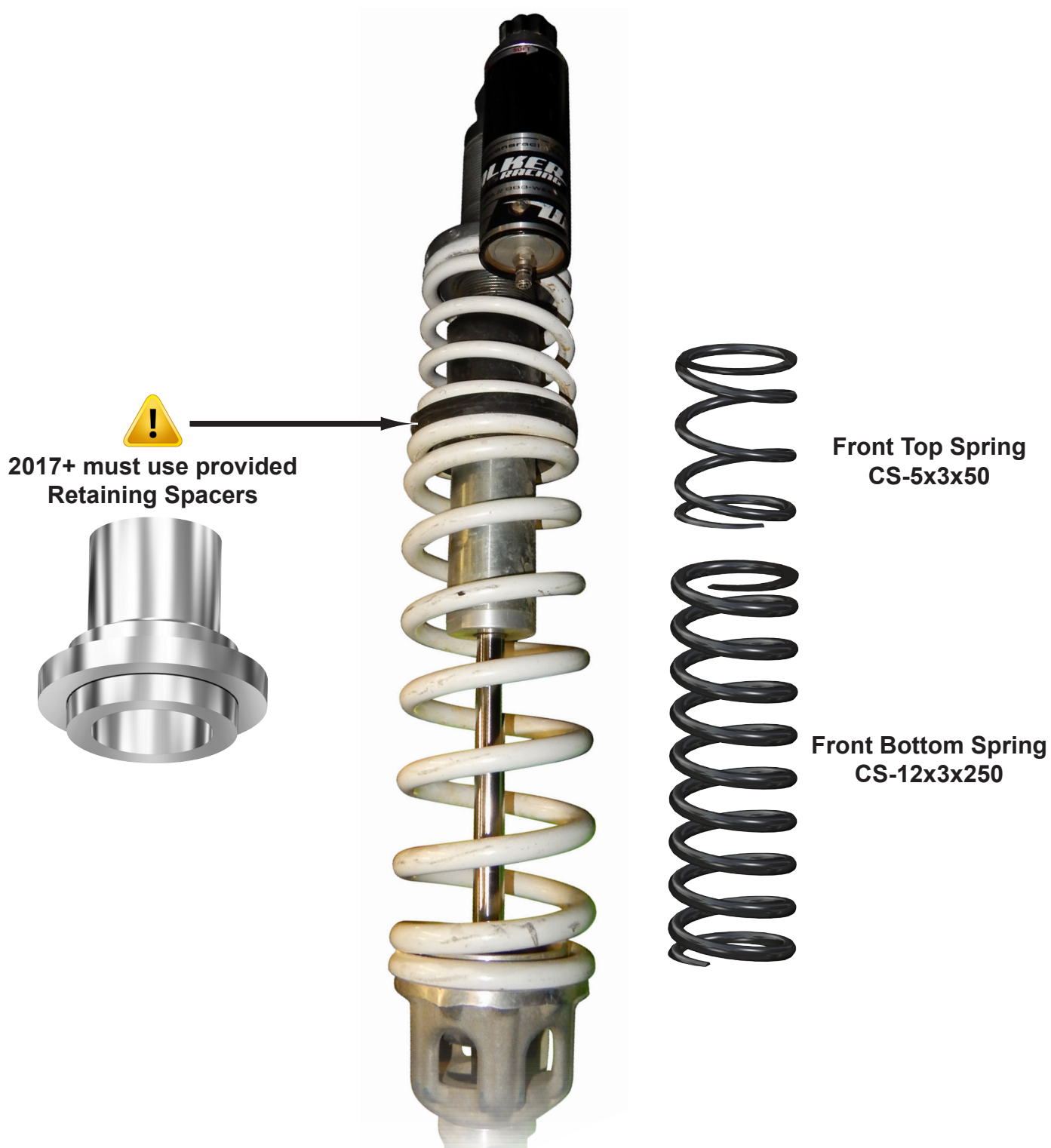

PIVOT BLOCK SETTINGS

- Place new A-Arms onto a flat surface and verify dimension shown.
- *Negative 1° camber setting is achieved when Pivot Blocks are set to this dimension.*
- See last page for additional camber information.

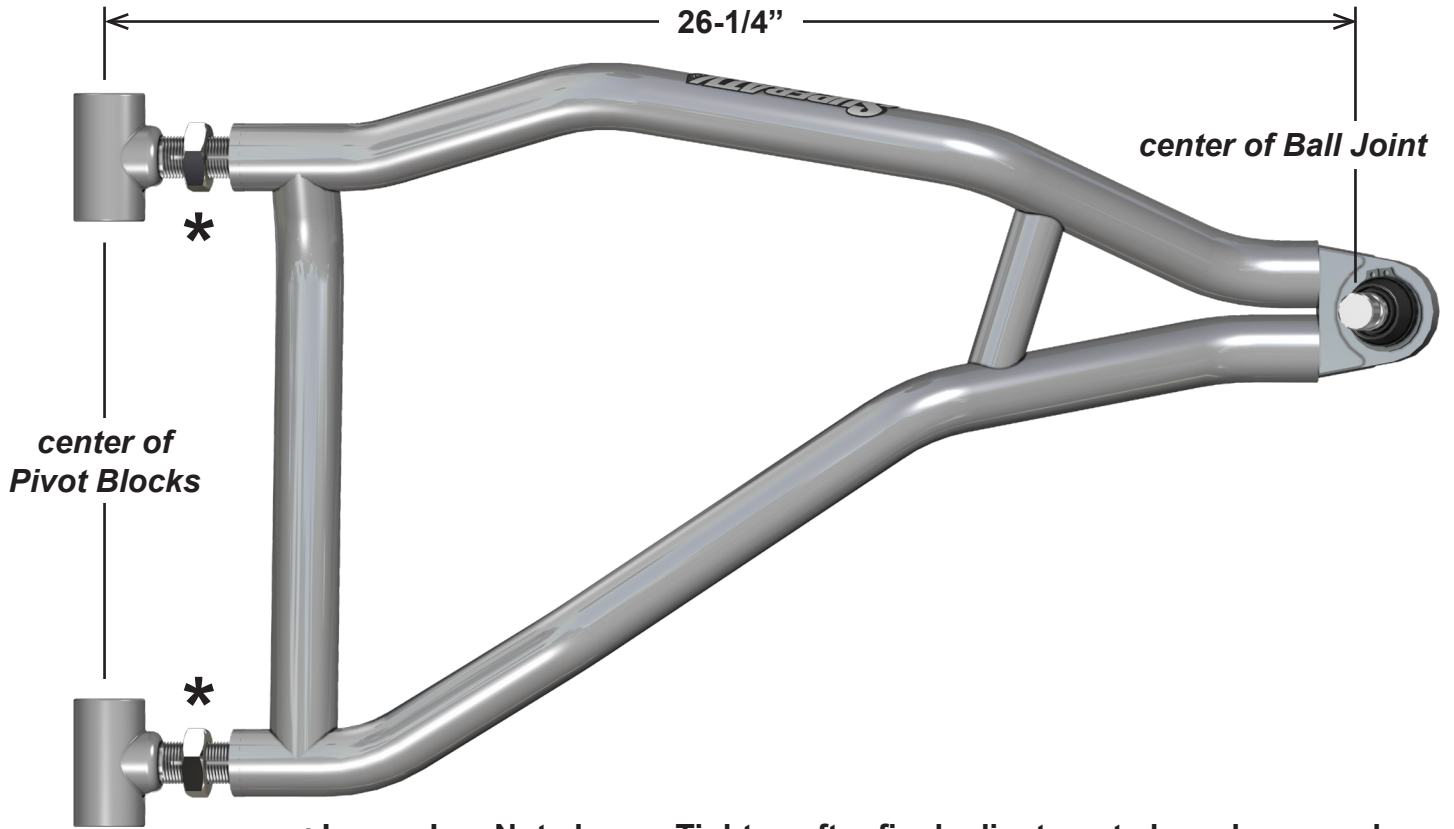

*** Leave Jam Nuts loose. Tighten after final adjustments have been made.**

Front:

- Install new Axle.
- Secure A-Arms (C)(D) to Frame with stock hardware. **Do not install any Nuts to Lower Arms all final adjustments have been completed.**
- Repeat for opposite side.

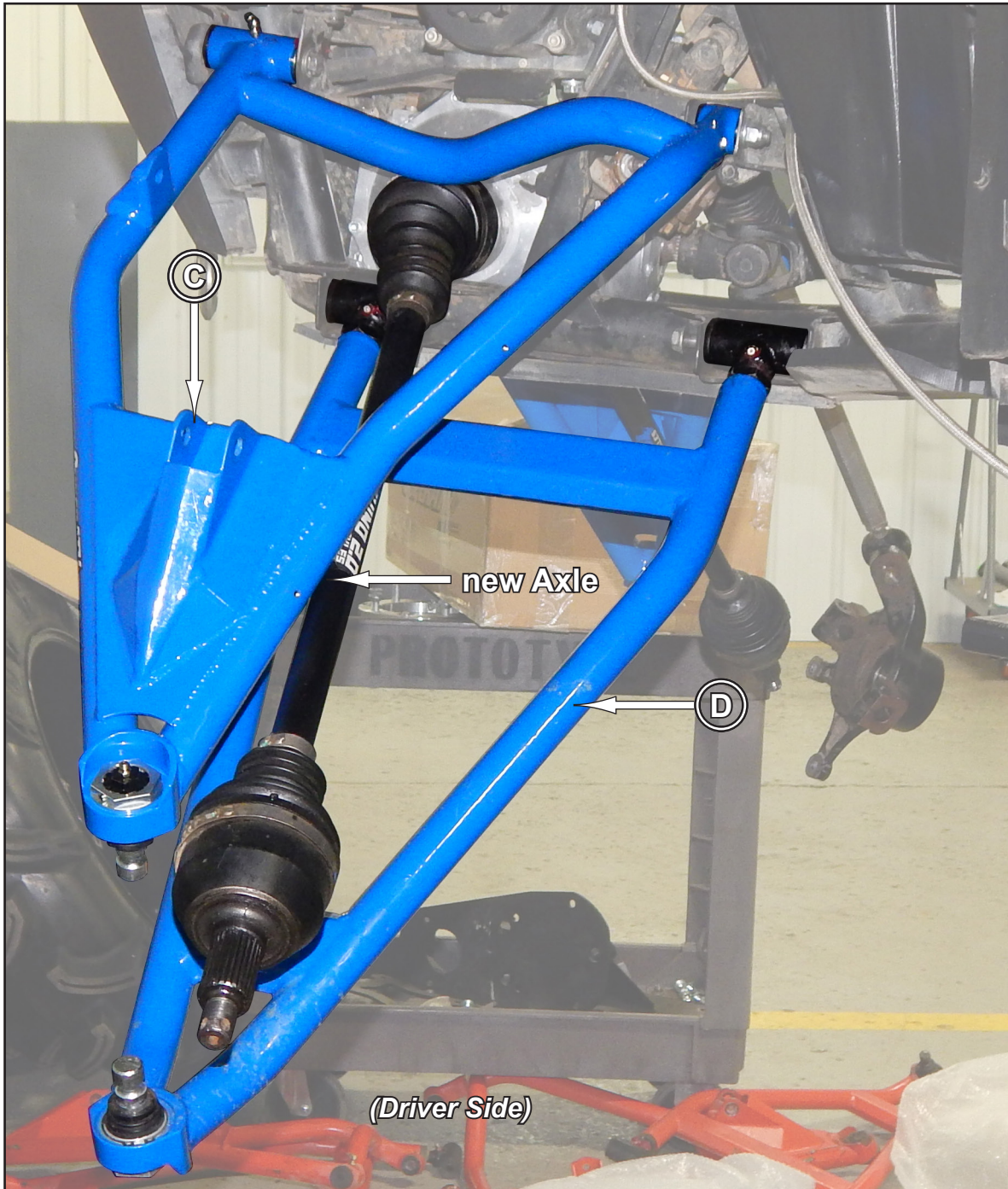

Refer to TRRA-P-RZR1K-3-14 installation instructions and install Tie Rods at this time.

- Secure Shock to Frame and Driver Upper A-Arm (C) with stock hardware.
- Repeat for opposite side.
- Reinstall stock components to A-Arms with stock hardware.
- Install provided Brake Lines and secure to A-Arms (C)(D) with provided Brake Line Clips and hardware.
- Ensure that no binding or rubbing can occur after installation.

Rear components shown must be removed; Keep all components removed from machine.

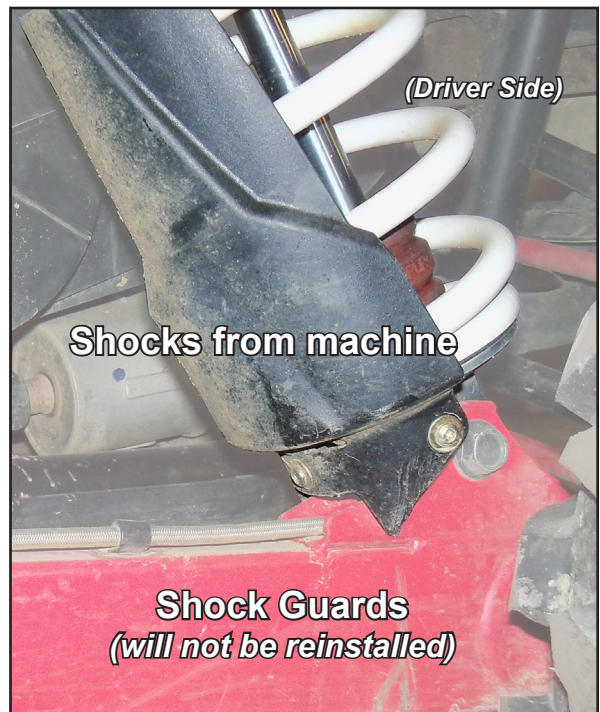
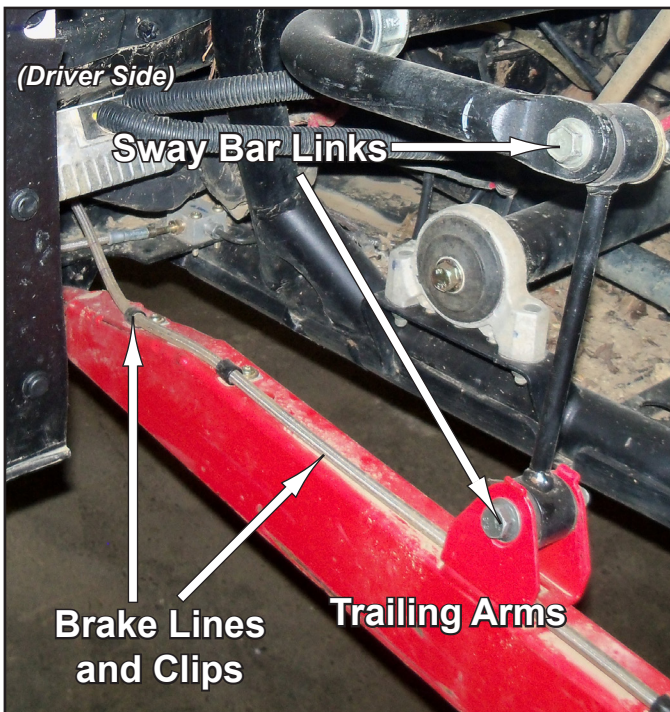
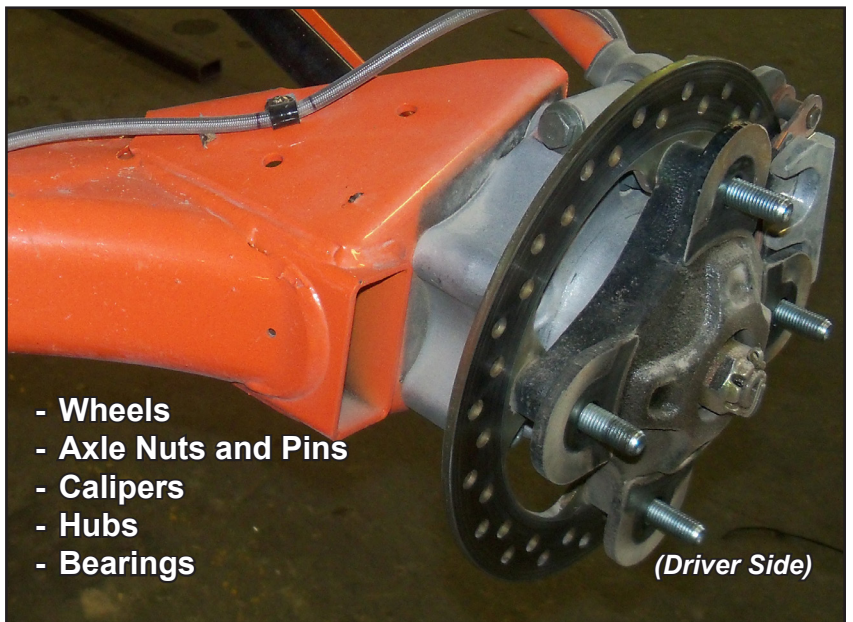
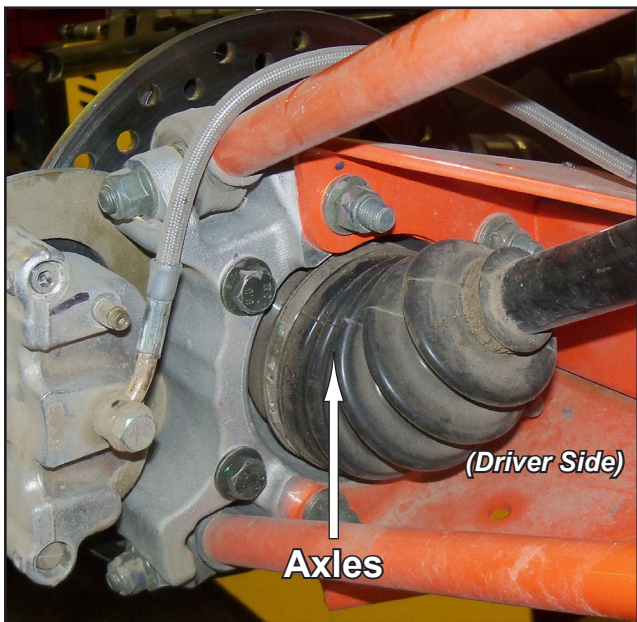
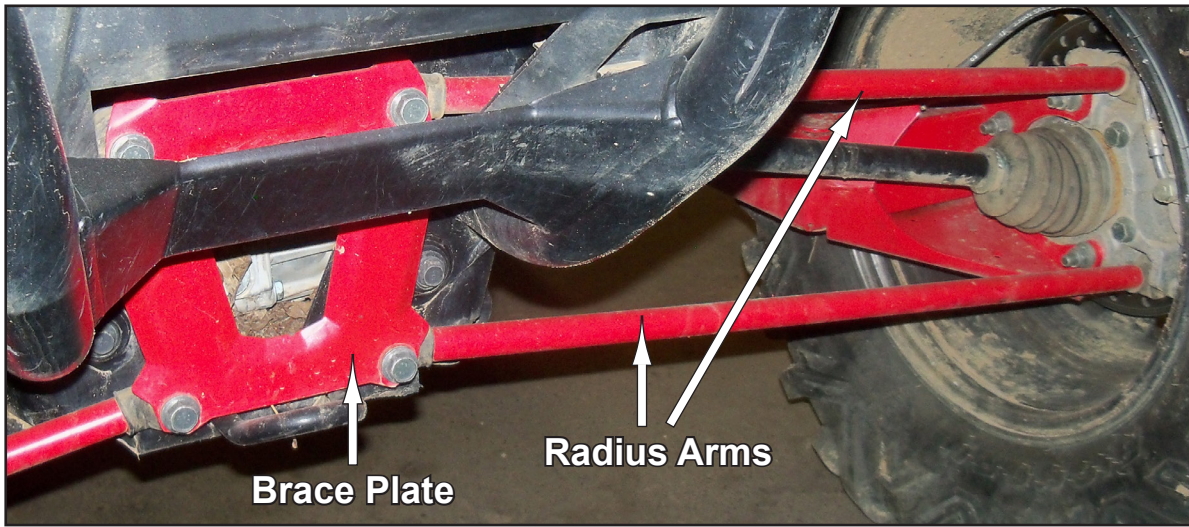

disregard if installing *LTK-P-RZRXP-CHC* or *LTK-P-RZRXP-CHC-002* kits

SuperATV strongly recommends using a spring compressor when removing Springs

Rear Springs Prep:

- Replace stock Bottom Springs with supplied SuperATV Spring p/n CS-16x3x350.



**Rear Bottom Spring
CS-16x3x350**



Rear:

- Secure Passenger Trailing Arm (K) to stock mounting location with stock hardware and supplied Trailing Arm Bushings.
- Install new Axle.
- Install Wheel Bearing to Passenger Trailing Arm (K) with stock hardware.
- Secure Shock to stock mounting location and Passenger Trailing Arm (K) with stock hardware.
- Repeat steps for opposite side.
- Tighten all hardware completely.

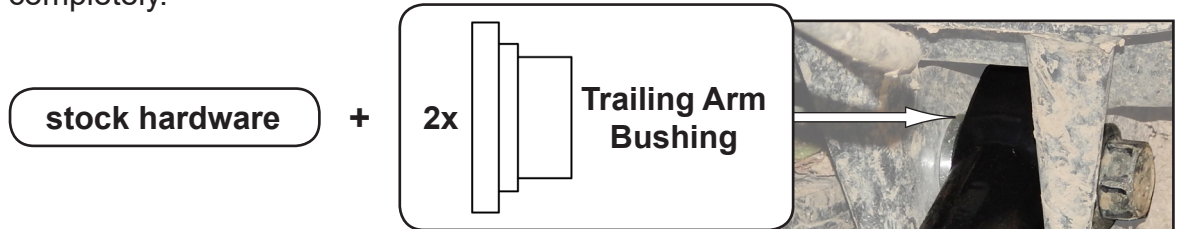

Rear continued:

- Secure Axles and Hubs to Wheel Bearings.
- Tighten all hardware completely.



Radius Arms Prep:

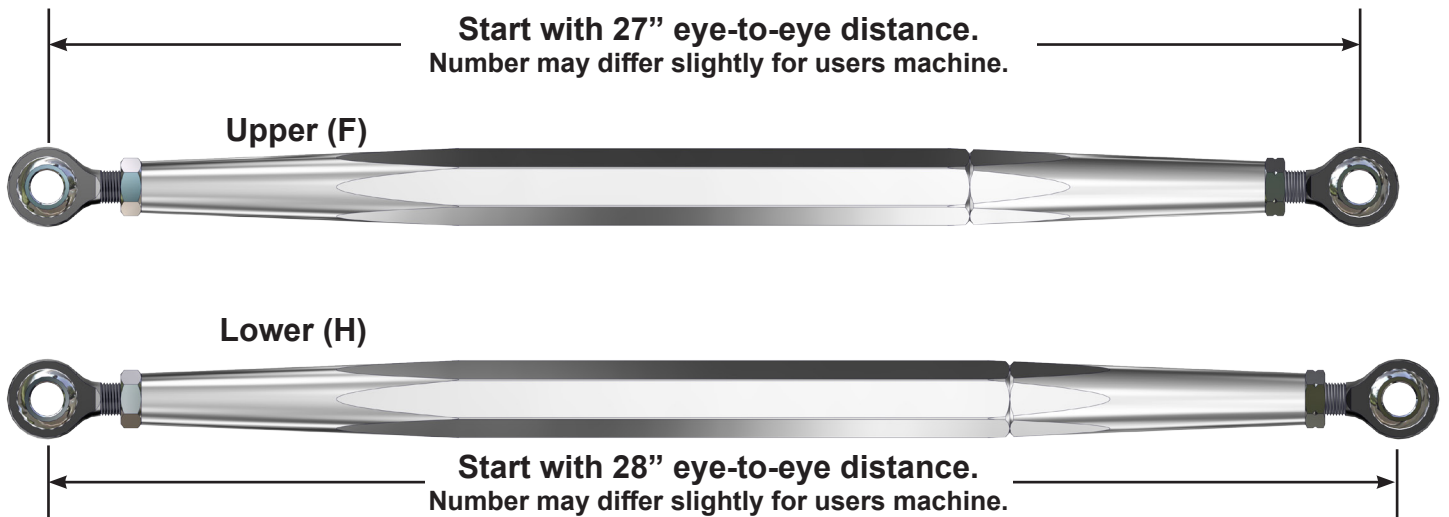

! See following page for Radius Arms installation options.

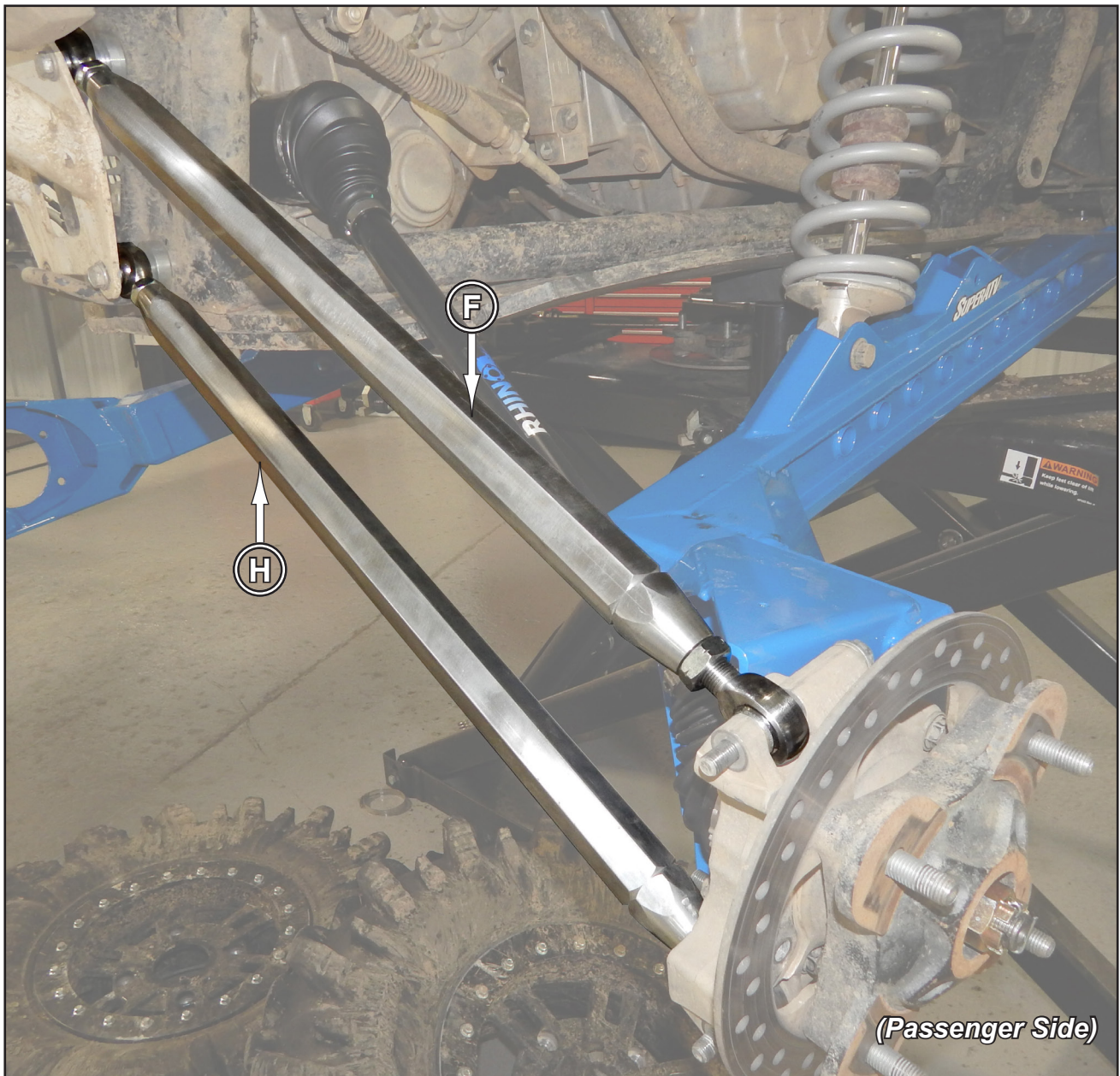

Radius Arms: *passenger side shown.*

- If machine has SuperATV RB-P-RZR1K Rear Bumper see "Install Option A".
- Machines without a Rear Bumper use "Install Option B".
- Use stock hardware when securing.
- Repeat for opposite side. Tighten stock hardware completely.

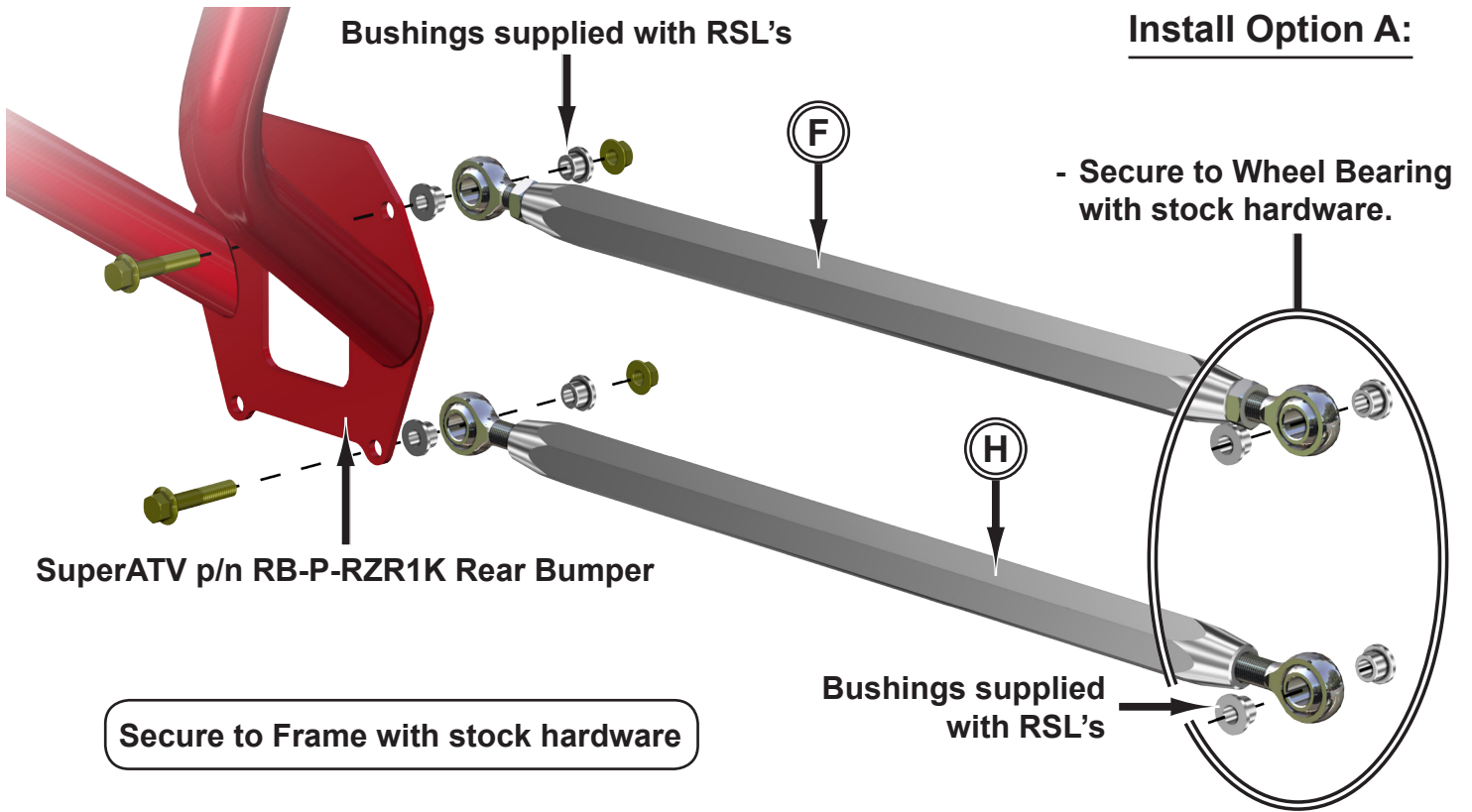

Install Option B:

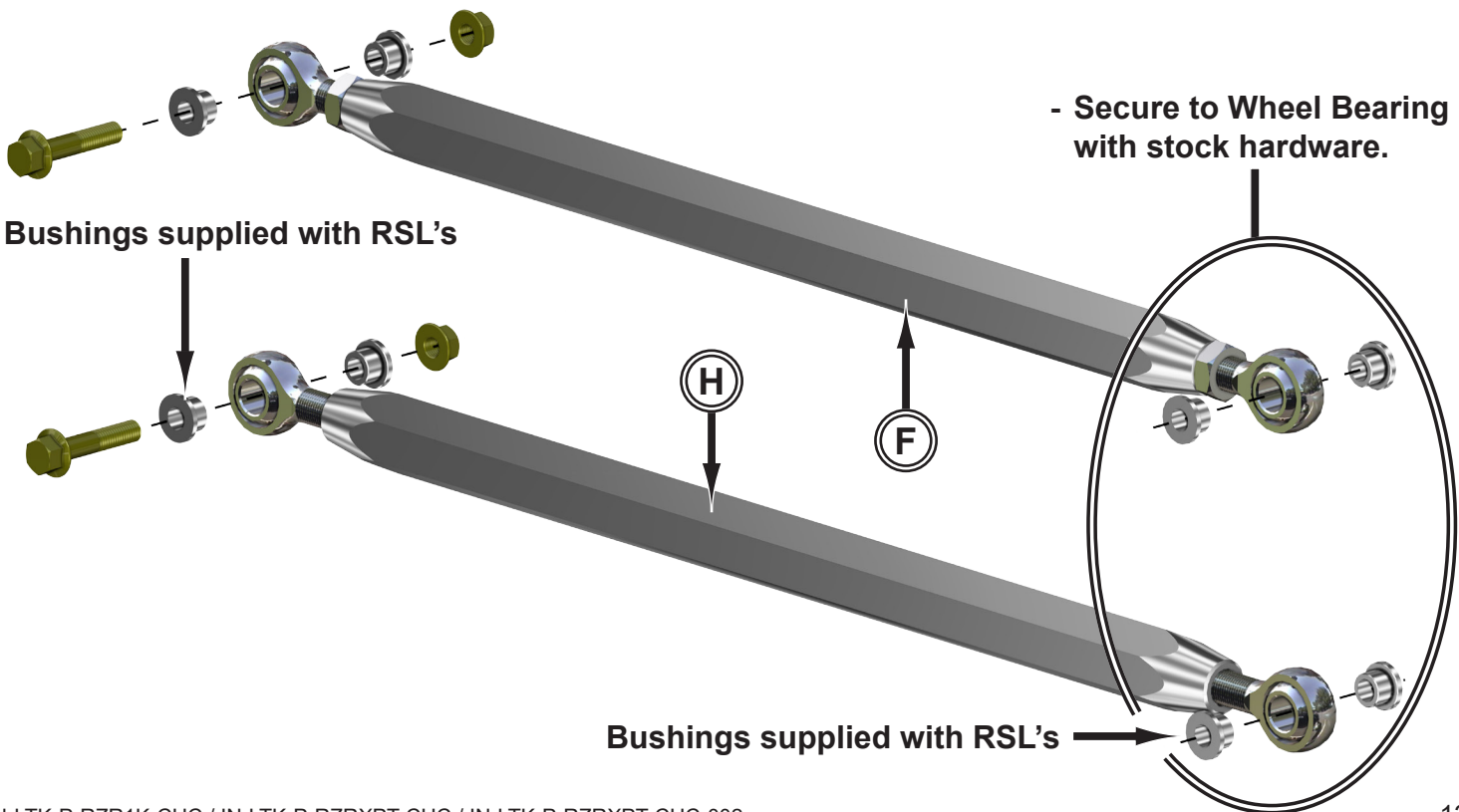

Radius Arms Adjustment:

- If Hubs and Axles do not rotate freely, equally adjust Radius Arms “out” in small increments.
- Tighten hardware completely.

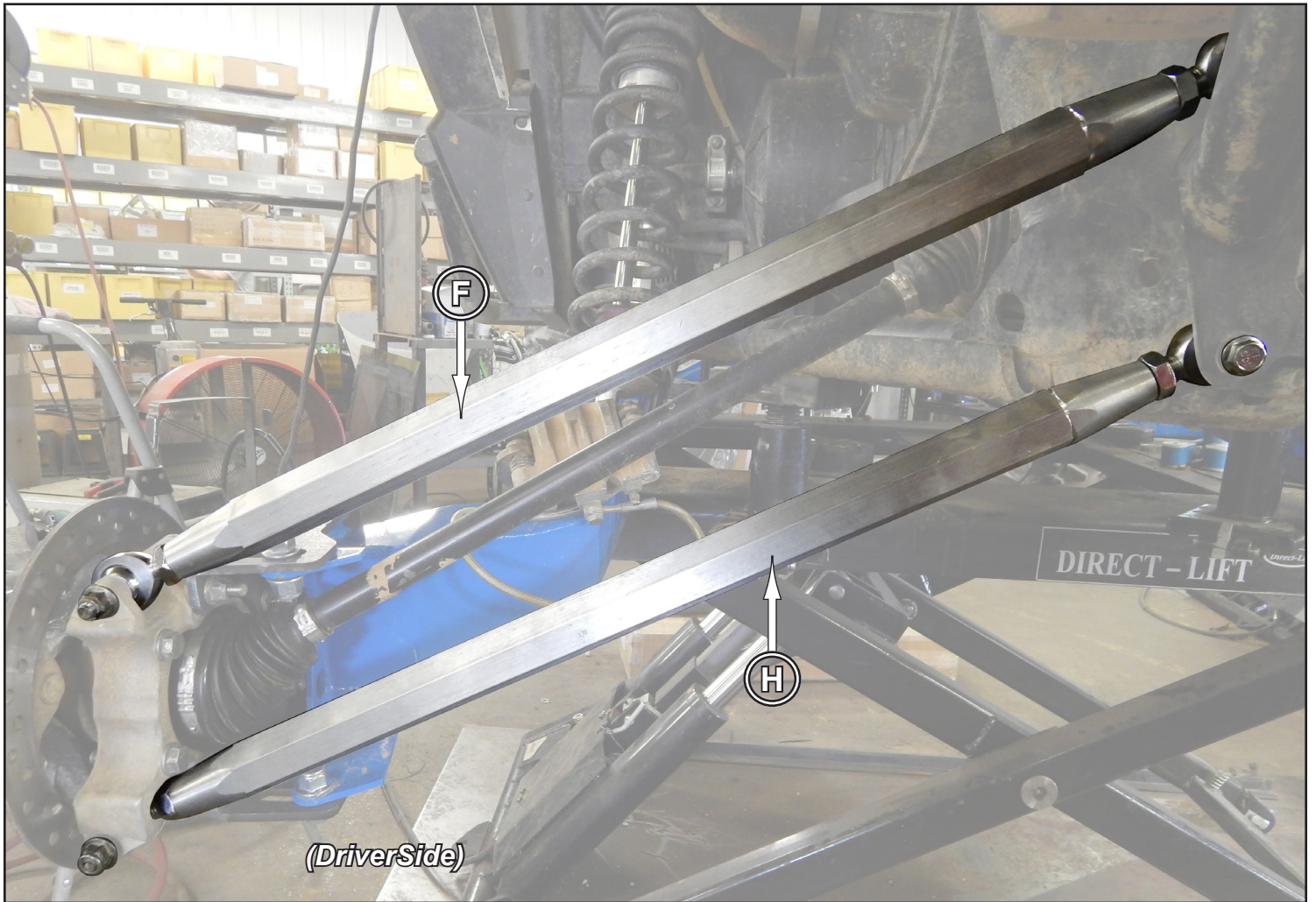

Rear Brake Line:

- Install provided Brake Lines and secure to Trailing Arms (K)(J).
- Ensure that no binding or rubbing can occur after installation.

6 each



Brake Line Clip and hardware

Rear Brake Lines have different style fittings at each end.



Approximately
90-1/2" Lg.

(Passenger Side)

K

(Passenger Side)

K

Rear continued:

- Secure Sway Bar Link (G) to Trailing Arm and Sway Bar with stock hardware and supplied Bushings.
- Repeat steps for opposite side.
- Tighten all hardware completely.

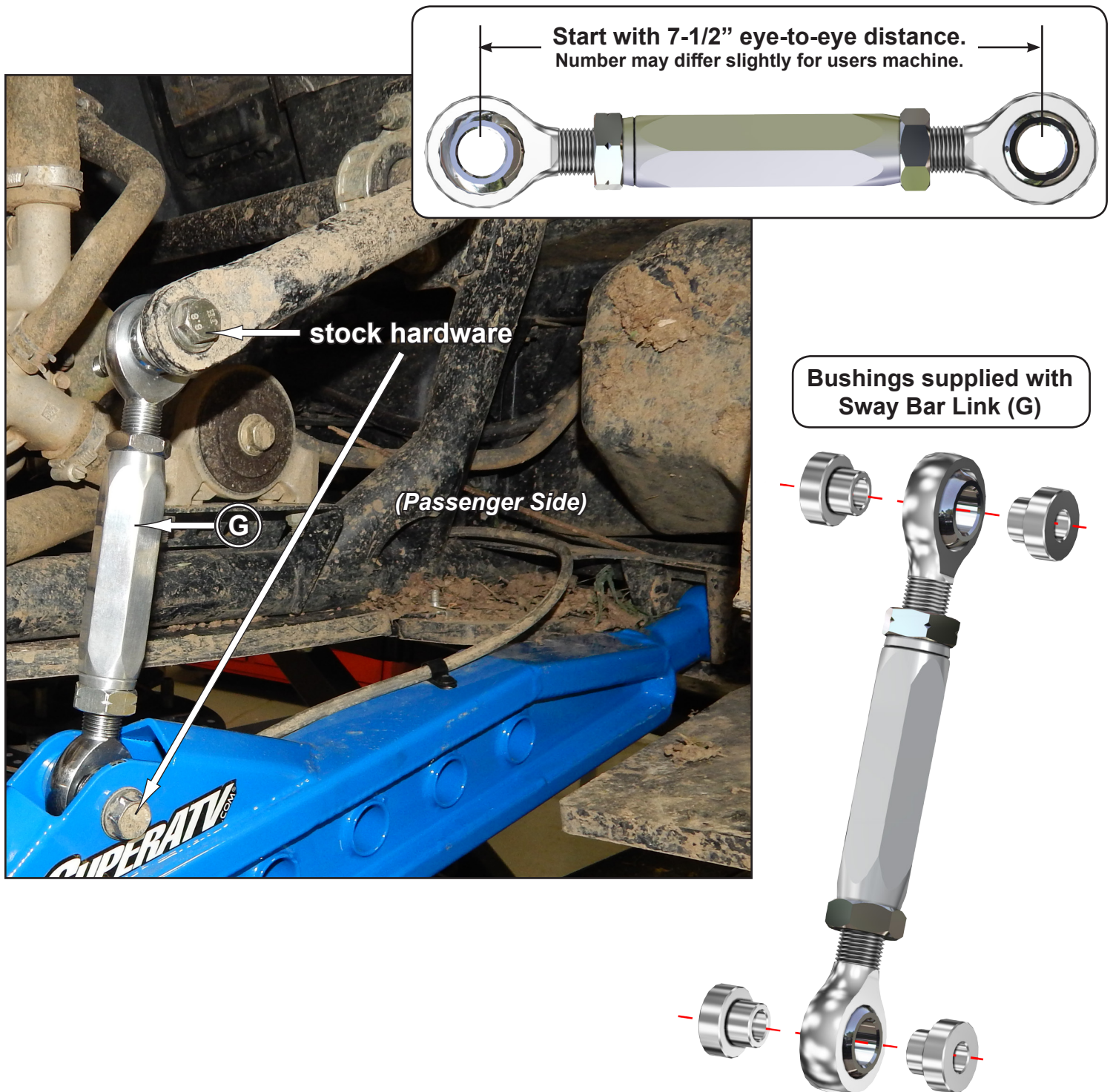

- Reinstall Tires and check Camber settings; see last page.
- Add Nuts to previously installed hardware and tighten completely. SuperATV recommends using Loc-Tite on Nuts.

Heavy Duty Tie Rod Kit



2014 Hardware x 2

Tie Rod Kit

2015+ Hardware

Large Boot

Small Boot



(stock Boots may be reused)



Wire Ties
 (2 x short and 2 x long)

Need help with your installation?



sales@superatv.com



www.superatv.com



1-855-743-3427



8:00am - 8:00pm EST M-Th
 8:00am - 7:00pm EST Friday
 9:00am - 2:00pm EST Saturday

Read instructions and view illustrations before beginning.

*Thank You
 For Choosing*



1. Remove stock Tie Rods from Spindles and Rack and Pinion.
2. Install Ball and Socket to Rack and Pinion. Use Loctite. See Fig. 1.
3. Remove, and keep, Jam Nut from Ball and Socket. See Fig. 1.
4. Install Boot, or reuse stock, as shown in Fig. 2. Use a lubricant to ease installation.
5. Reinstall Jam Nut and install Shaft to Ball and Socket. See Fig. 2.
6. Secure Rubber Boot with Wire Ties. See Fig. 2.

Kit includes hardware for 2014 and 2015+ models. Use stock Spindle hardware to determine which hardware kit to use. See page 3.

7. Secure Tie Rod End to Spindle with supplied hardware.
8. Repeat steps for opposite side.

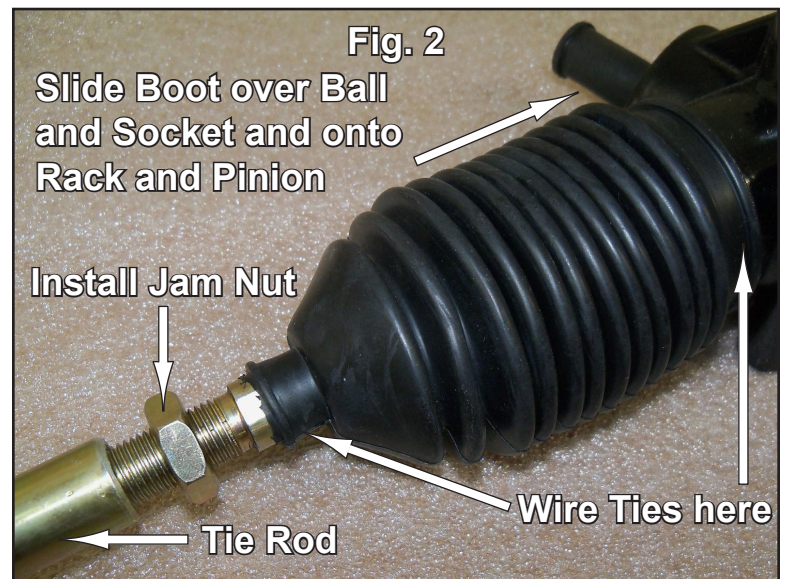
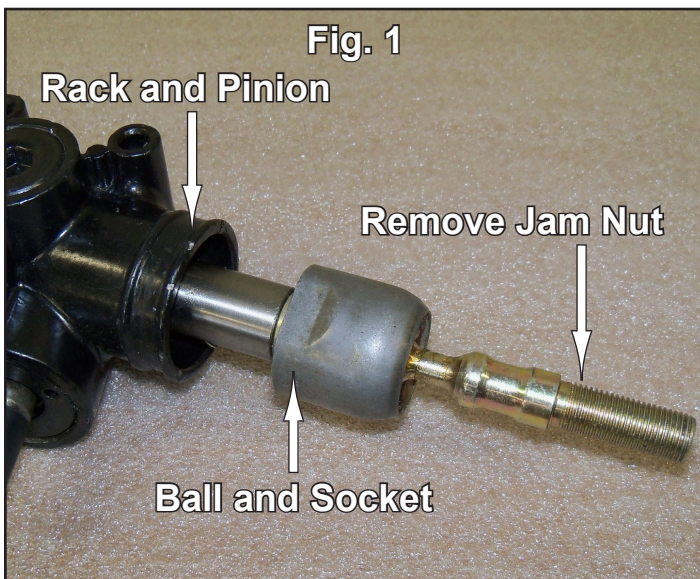

(Rack and Pinion shown off machine for clarity)

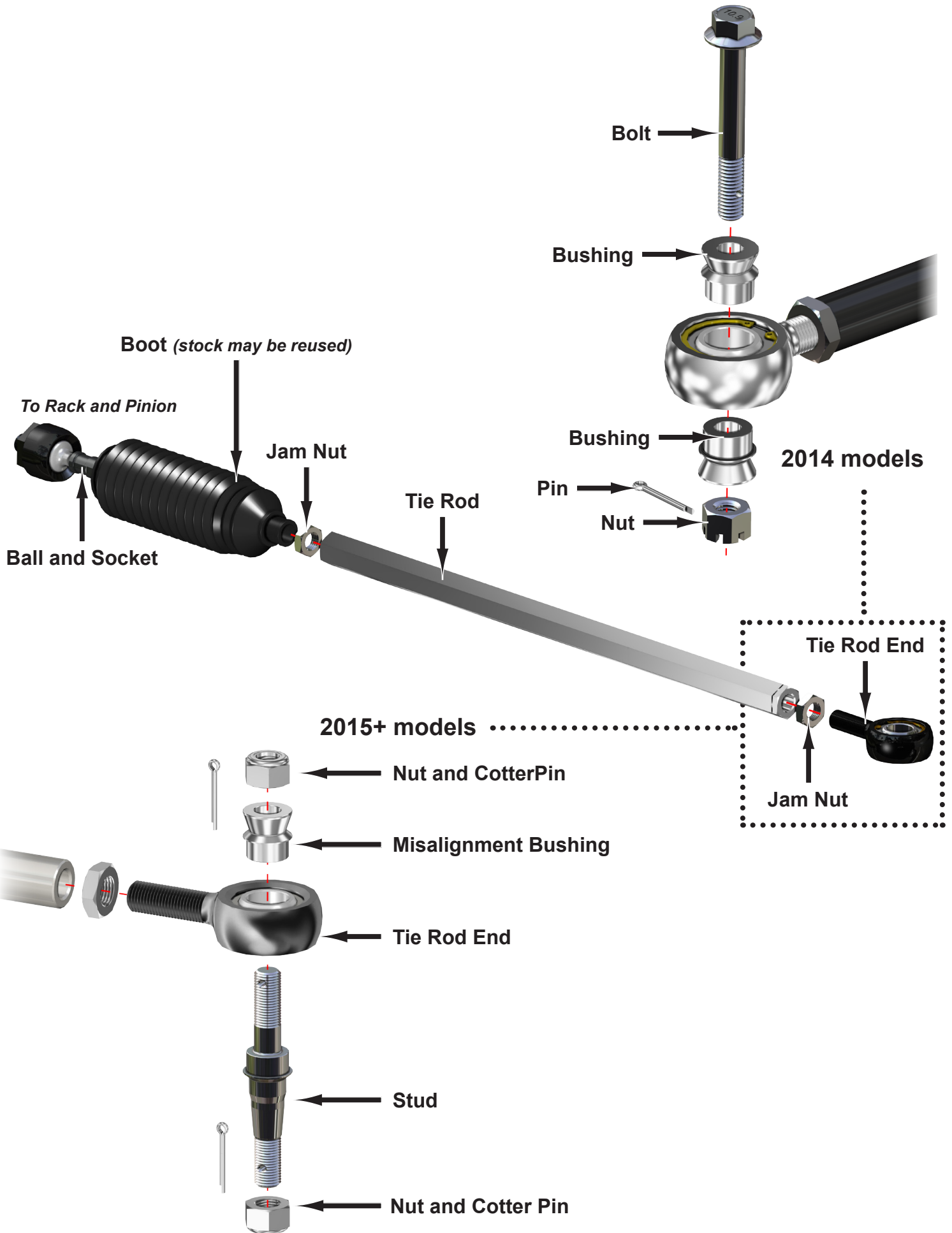

CUSTOMER NOTIFICATION AND DISCLAIMER LIABILITY

This product is a modification for utility task vehicles and all terrain vehicles. Use this product at your own risk.

Warranty and Liability Limitations. The Buyer hereby assumes all risks associated with the use and/or installation of this product. Buyer waives all liability claims against SuperATV® of any kind or nature, including, but not limited to, liability for penalties, fines, property damage, personal injury or death, to the fullest extent permitted by law. Buyer acknowledges and agrees that SuperATV® is not liable for any direct, indirect, incidental, consequential or special damages, including but not limited to, damage, loss of life, loss of property or equipment, loss of profits or revenue, injury, or claims from any individual or entity arising from the use of this product.

The warranty for this product, if any, may give you ("Buyer") specific legal rights, and Buyer may also have other rights which may vary from state to state. The installation of this product may void or otherwise adversely affect your factory warranty.

Consult your vehicle warranty before using this Product. Under no circumstances will SuperATV® be liable for the voidance of the Buyer's vehicle warranty. Buyer assumes all risk and responsibility if a manufacturer and/or dealer voids the Buyer's vehicle warranty due to use of this Product.

Safety and Laws. Operate your vehicle at all times in a safe manner. You must abide by all local, state, and federal laws, including but not limited to vehicle safety, traffic laws, and ordinances. It is your responsibility to know the laws and how they apply to you. The installation of this product may violate certain local, state, and federal laws. Be advised that laws vary depending on town, city, county, state, etc. Use of this product on public streets, roads, or highways may be in violation law. The Buyer is solely and exclusively legally and personally responsible for any violation of the law by the installation or use of this product. In no case will SuperATV® be held liable if Buyer violates the law or uses the product in an unsafe manner.

The Buyer is responsible to fully understand the capability and limitations of his/her vehicle according to manufacturer specifications, warnings and instructions and agrees to hold SuperATV® harmless from any damage resulting from failure to adhere to such specifications, warnings and/ or instructions. The Buyer is also responsible to obey all applicable federal, state, and local laws when operating his/her vehicle while using this product, and the Buyer agrees to hold SuperATV® harmless from any violation thereof.

Installation. The installation of this product on your vehicle indicates that you have had the opportunity to inquire about applicable local, state, and federal laws and ordinances and that you have read and understand, and accept all of the terms of, this Disclaimer.

SuperATV® shall not be responsible for the proper installation, use, and service of this product. Rather, the Buyer shall be solely responsible for the installation of the product and any damage that may be done to the vehicle or vehicle components as a result of modifications made by the Buyer.

INSTALLATION INSTRUCTIONS
Ball Joint Notes

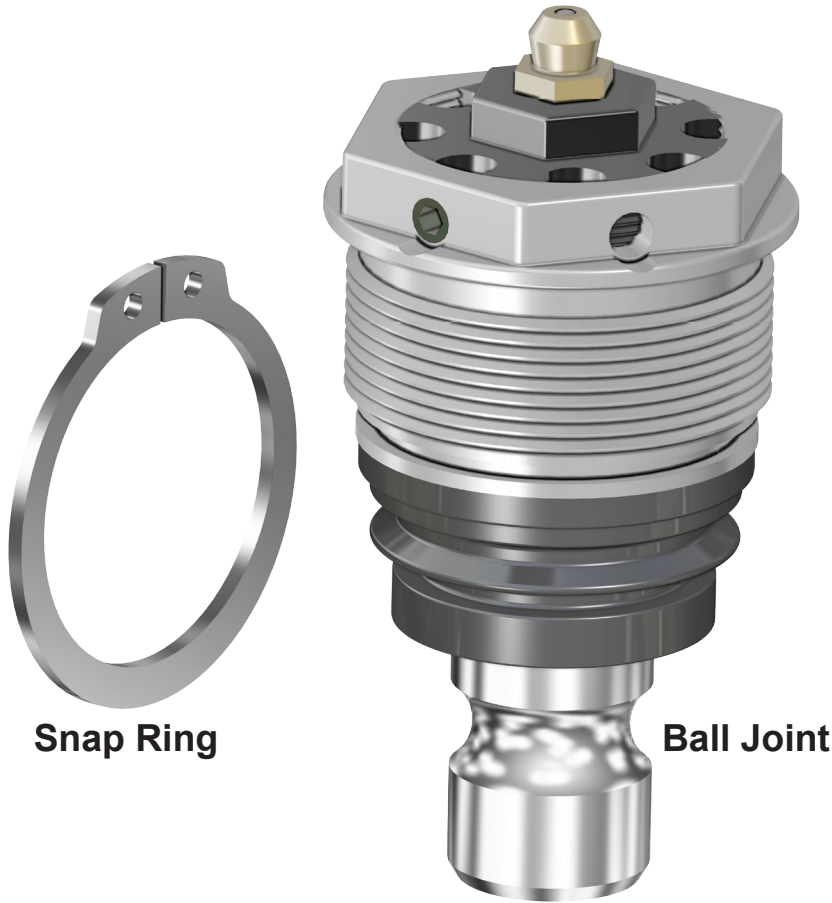

Snap Ring

Ball Joint

Liability Statement

SuperATV's[®] products are designed to best fit user's ATV/UTV under stock conditions. Adding, modifying, or fabricating any factory or aftermarket parts will void any warranty provided by SuperATV[®] and is not recommended. SuperATV's[®] products could interfere with other aftermarket accessories. If user has aftermarket products on machine, contact SuperATV[®] to verify that they will work together.

Although SuperATV[®] has thousands of satisfied customers, user should be aware that installing lift kits, long travel, or suspension kits, tires, etc. will change the ride of machine and may increase maintenance and part wear. Operating any off-road machine while, or after, consuming alcohol and/or drugs increases risk of bodily harm or death. No warranty or representation is made as to this product's ability to protect user from severe injury or death. SuperATV[®] urges operators and occupants to wear a helmet and appropriate riding gear at all times.

By purchasing and installing SuperATV[®] products, user agrees that should damages occur, SuperATV[®] will not be held responsible for loss of time, use, labor fees, replacement parts, or freight charges. SuperATV[®], nor any 3rd party, will not be held responsible for any direct, indirect, incidental, special, or consequential damages that result from any product purchased from SuperATV[®]. The total liability of seller to user for all damages, losses, and causes of action, if any, shall not exceed the total purchase price paid for the product that gave rise to the claim.

SuperATV[®] will warranty only parts provided by SuperATV[®]. Any damage or problems with OEM housings, bearings, seals, or other manufacturers' products will not be covered by SuperATV[®]. SuperATV[®] parts and products are not warranted if item was not installed properly, misused, or modified.

Installing, adding, modifying, or fabricating any factory or aftermarket product to your ATV/UTV may violate certain local, state, and federal laws. Be advised that laws vary depending on town, city, county, state, etc. Use of certain products on public streets, roads, or highways may be in violation law. The Buyer is solely and exclusively legally and personally responsible for any violation of the law by the installation or use of the product. You must abide by all local, state, and federal laws, including but not limited to vehicle safety, traffic laws, and ordinances. It is your responsibility to know the laws and how they apply to you.

The Buyer is responsible to fully understand the capability and limitations of his/her vehicle according to manufacturer specifications, warnings and instructions and agrees to hold SuperATV[®] harmless from any damage resulting from failure to adhere to such specifications, warnings and/ or instructions. The Buyer is also responsible to obey all applicable federal, state, and local laws and ordinances when operating his/her vehicle while using this product, and the Buyer agrees to hold SuperATV[®] harmless from any violation thereof.

Need help with your installation?



sales@superatv.com



www.superatv.com



1-855-743-3427



8:00am - 8:00pm EST M-Th
 8:00am - 7:00pm EST Friday
 9:00am - 2:00pm EST Saturday

Read instructions and view illustrations before beginning.

Thank You

For Choosing



- Ball Joint must be installed so that Screw can be removed.

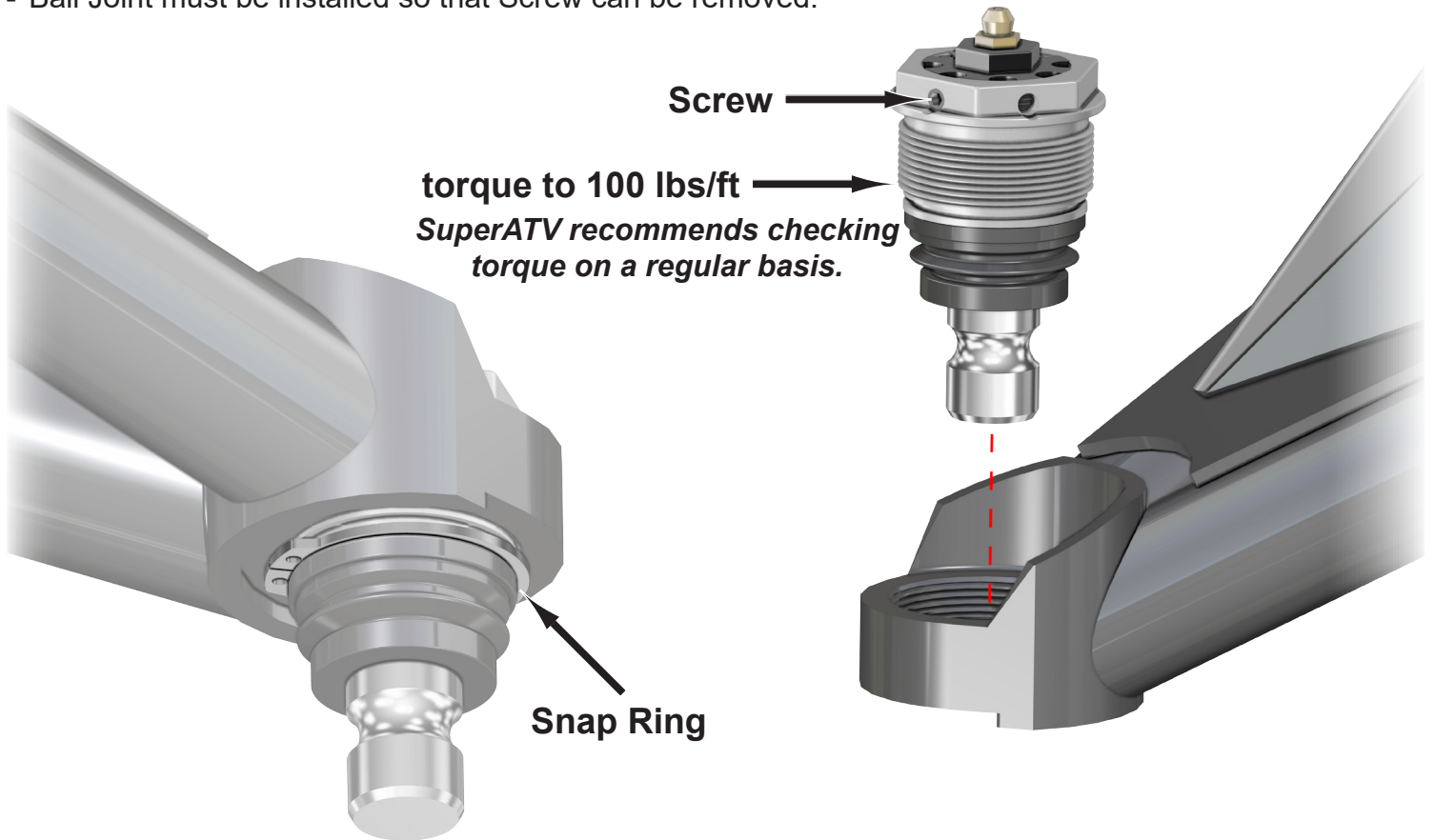

- Secure Ball Joint with provided Snap Ring.

- Adjustments can be made with Ball Joint installed on A-Arm.
- Loosen Screw and rotate Threaded Cap; left loosen - right tighten.
- Tighten Screw.

! DO NOT USE ZERK FITTING TO TIGHTEN OR LOOSEN.

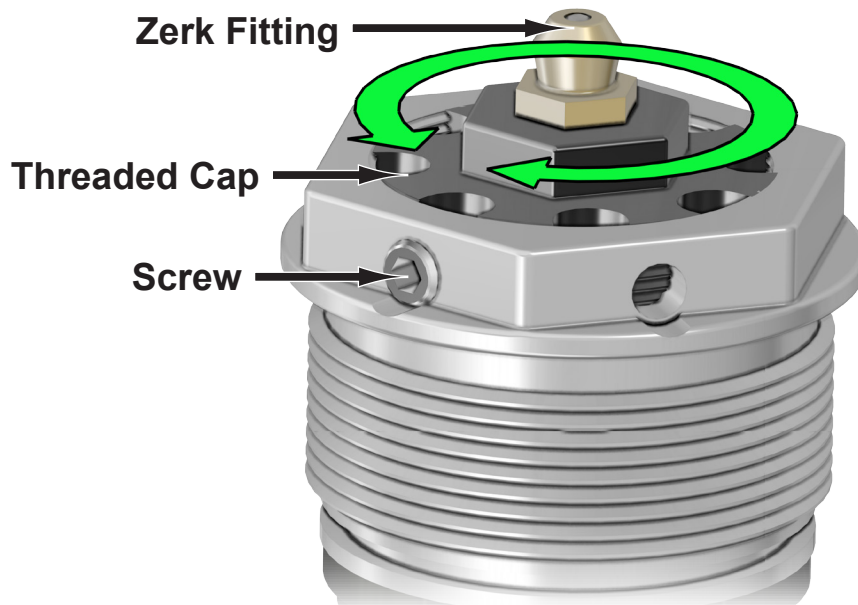

CAMBER

- Tires must have equal air pressure before making adjustments.
- Adjustments to be made after all suspension components have been completely assembled.
- Tires must not be in contact with ground when making adjustments.
- Perform adjustments in small increments.

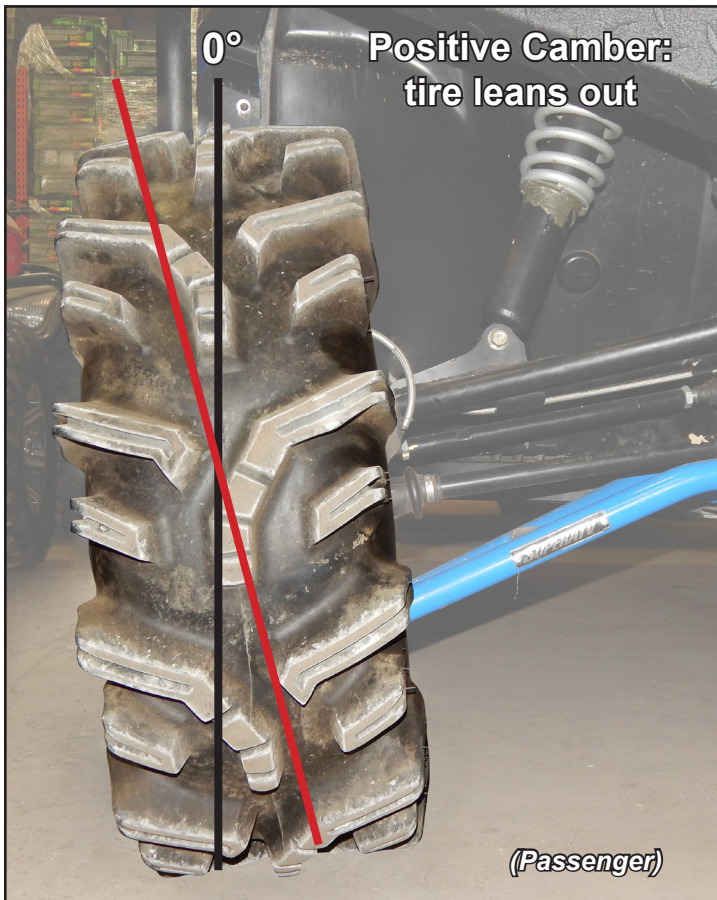

Adjusting Camber:

- Remove A-Arms from Frame and turn Pivot Blocks to adjust camber. Reinstall Arms.
- Lower machine and settle suspension components by rolling machine back and forth several feet at a time.
- Check settings and make small adjustments as needed.
- Each time an adjustment is made, machine must be rolled back and forth to settle suspension components.
- Once desired setting is achieved, tighten hardware completely. Loc-tite on Nuts is recommended.

A NEGATIVE CAMBER SETTING OF 1° to 2° IS RECOMMENDED.

LOWER:

Too much positive camber: adjust Pivot Blocks **OUT**.

Too much negative camber: adjust Pivot Blocks **IN**.

note: 2 full turns is 1°

UPPER A-ARMS:

Too much positive camber: adjust Pivot Blocks **IN**.

Too much negative camber: adjust Pivot Blocks **OUT**.

note: 2 full turns is 1°

