

INSTALLATION INSTRUCTIONS
Full Doors: for Can-Am Defender

Item	Description
A	Driver Door
B	Passenger Door

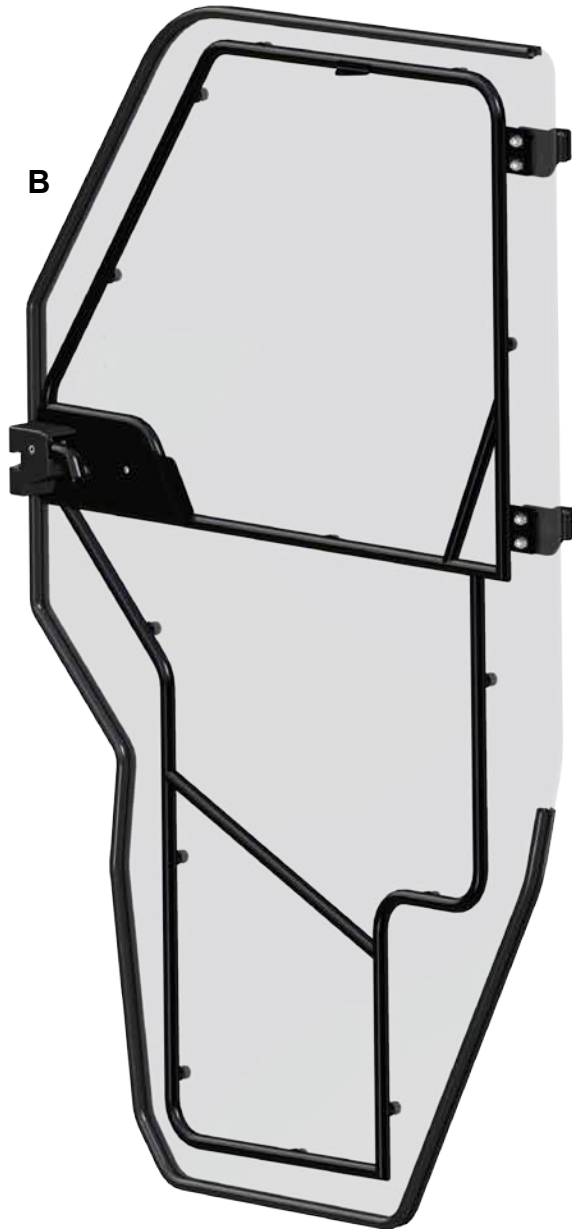
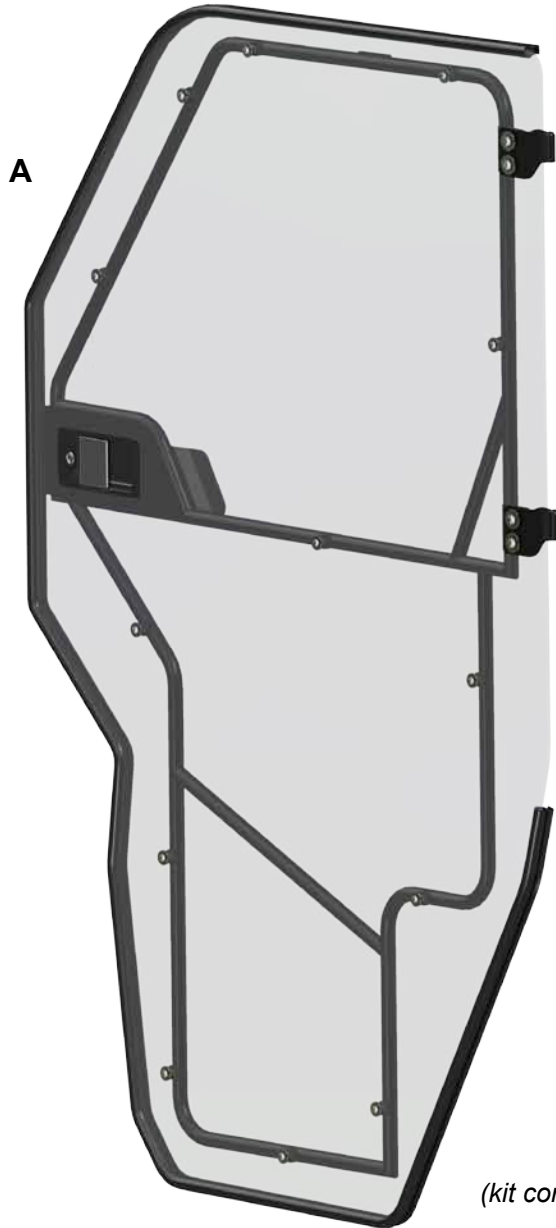

(kit contents continue on following pages)

Need help with your installation?

 sales@superatv.com
 www.superatv.com

 1-855-743-3427
  8:00am - 9:00pm EST M-Th
 8:00am - 7:00pm EST Friday
 9:00am - 2:00pm EST Saturday

Read instructions and view illustrations before beginning.

Thank You
For Choosing
SUPERATV.COM[®]



KEYS ARE LOCATED UNDER ORANGE TAPE. DO NOT DISCARD.



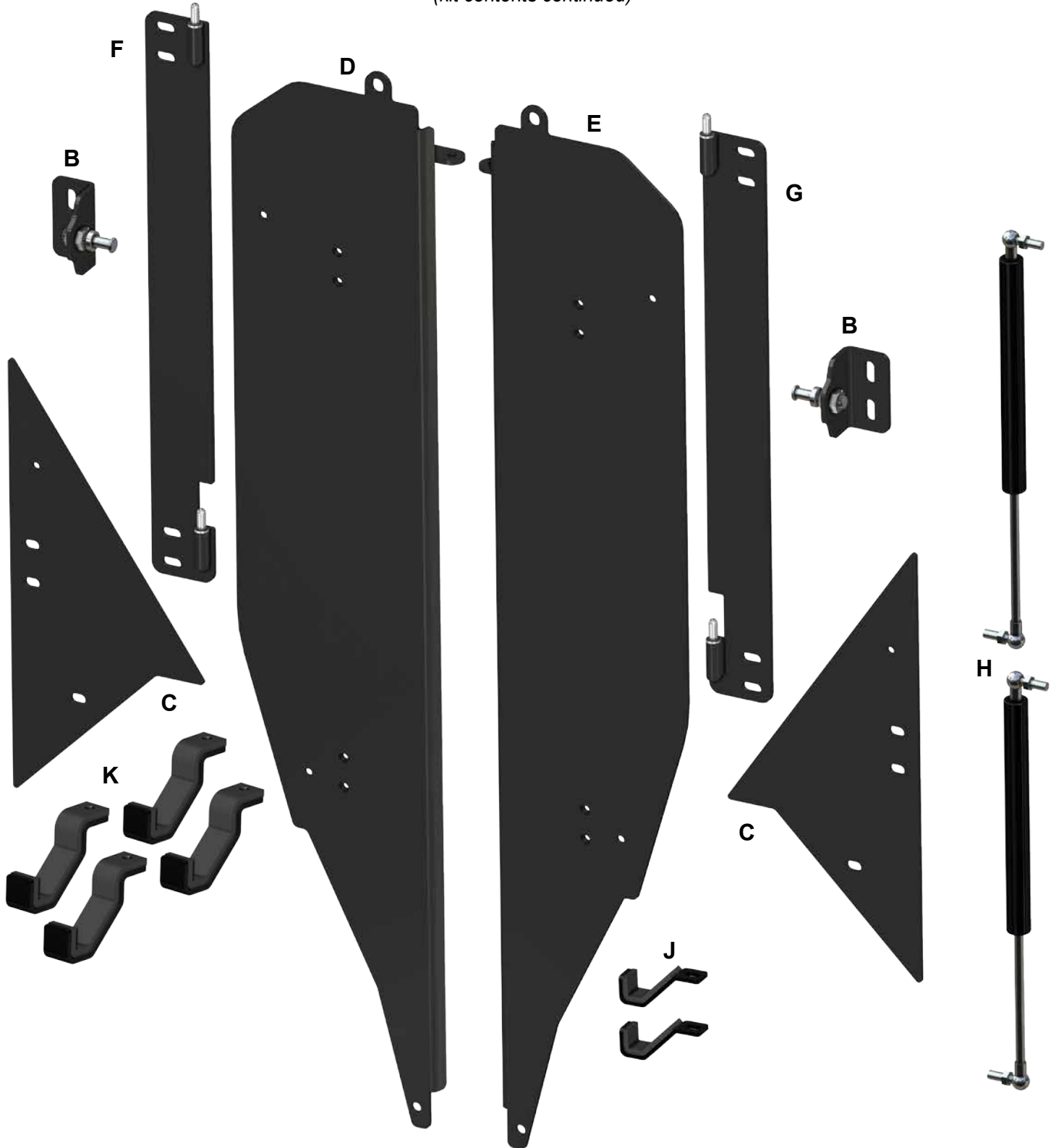

(kit contents continued)



Item	Description	Qty	Item	Description	Qty
B	Striker	2	G	Driver Hinge Assembly	1
C	Pillar Bracket	2	H	Gas Strut	2
D	Passenger Hinge Mount	1	J	Small Clamp	2
E	Driver Hinge Mount	1	K	Large Clamp	4
F	Passenger Hinge Assembly	1			

(kit contents continued)

4x  M5-.80 x 20mm Lg. FHCS

6x  M6-1.0 x 20mm Lg. BHCS

8x  M8-1.25 x 20mm Lg. BHCS

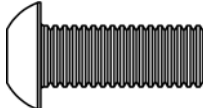
4x  M8-1.25 x 25mm Lg. BHCS

2x  M8-1.25 x 35mm Lg. BHCS

4x  M5-.80 Nylock Nut

6x  M6-1.0 Nylock Nut

2x  M8-1.25 "U" Nut

8x  M8 Acorn Nut

6x  M6 Washer

8x  M8-1.25 Nylock Nut

14x  M8 Washer

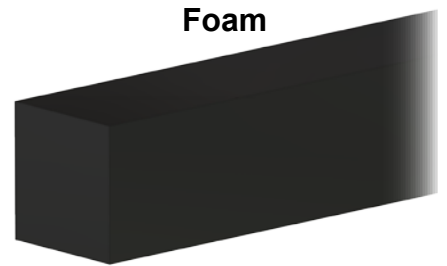

Cleaning:

- Do not use window cleaning fluids (Windex, 409, etc) or any solvents (gasoline, denatured alcohol, acetone, etc).
 - Never use abrasive cleaners, abrasive pads, or gritty cloths.
 - Never use razor blades, scrapers, squeegees, brushes, etc.
1. Thoroughly rinse to float off dirt and mud.
 2. Using a soft cloth, or microfiber cloth, clean with warm water and a gentle detergent. Baby shampoo or hand washing soap are recommended.
 3. To prevent water spots, use a chamois to blot dry.

Removal: keep all components removed from machine.

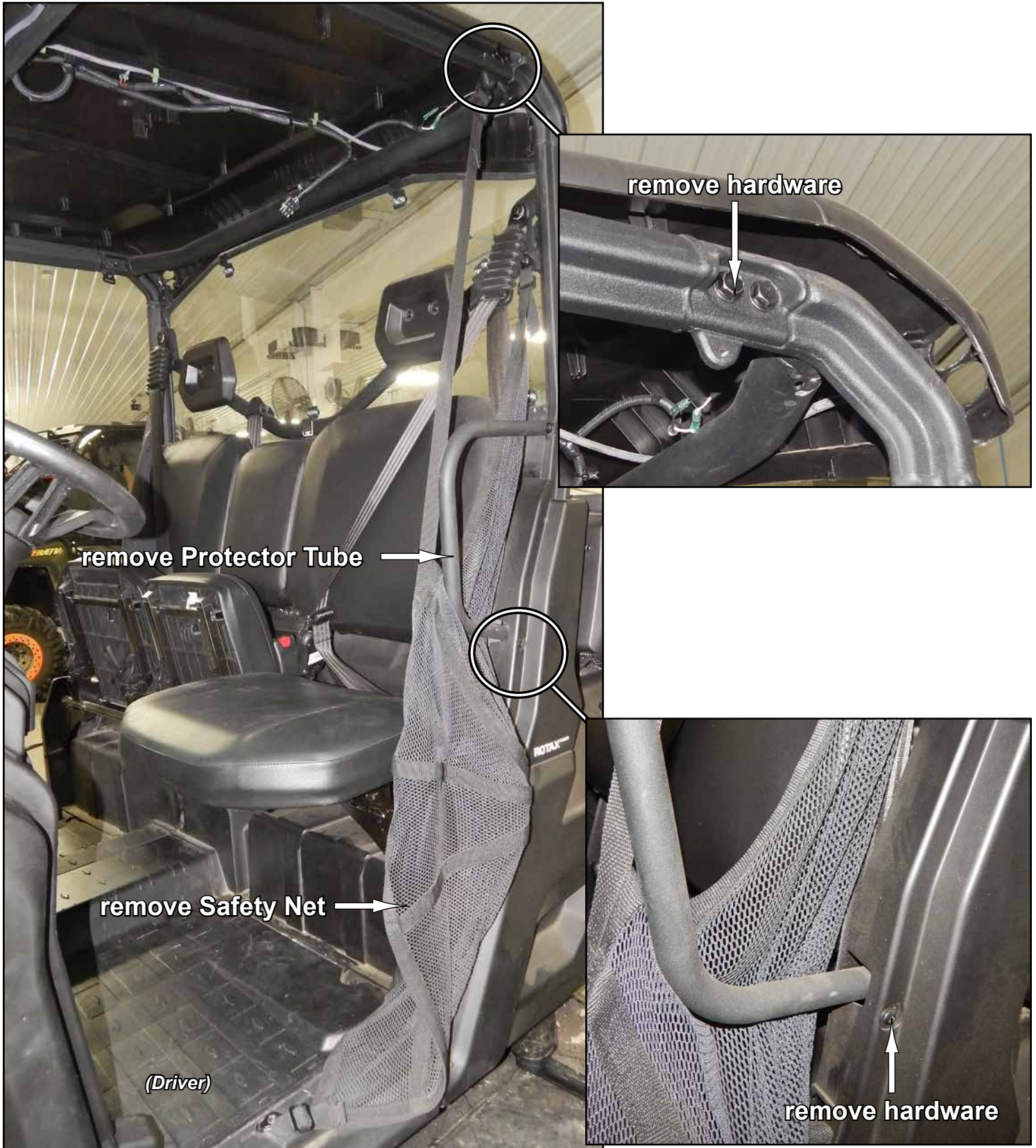

Driver Door Installation: do not tighten hardware completely unless noted.

- Install Driver Hinge Mount (E) to Frame with stock hardware. Tighten hardware.
- Install Driver Hinge Assembly (G) to Driver Hinge Mount (E) with hardware shown.

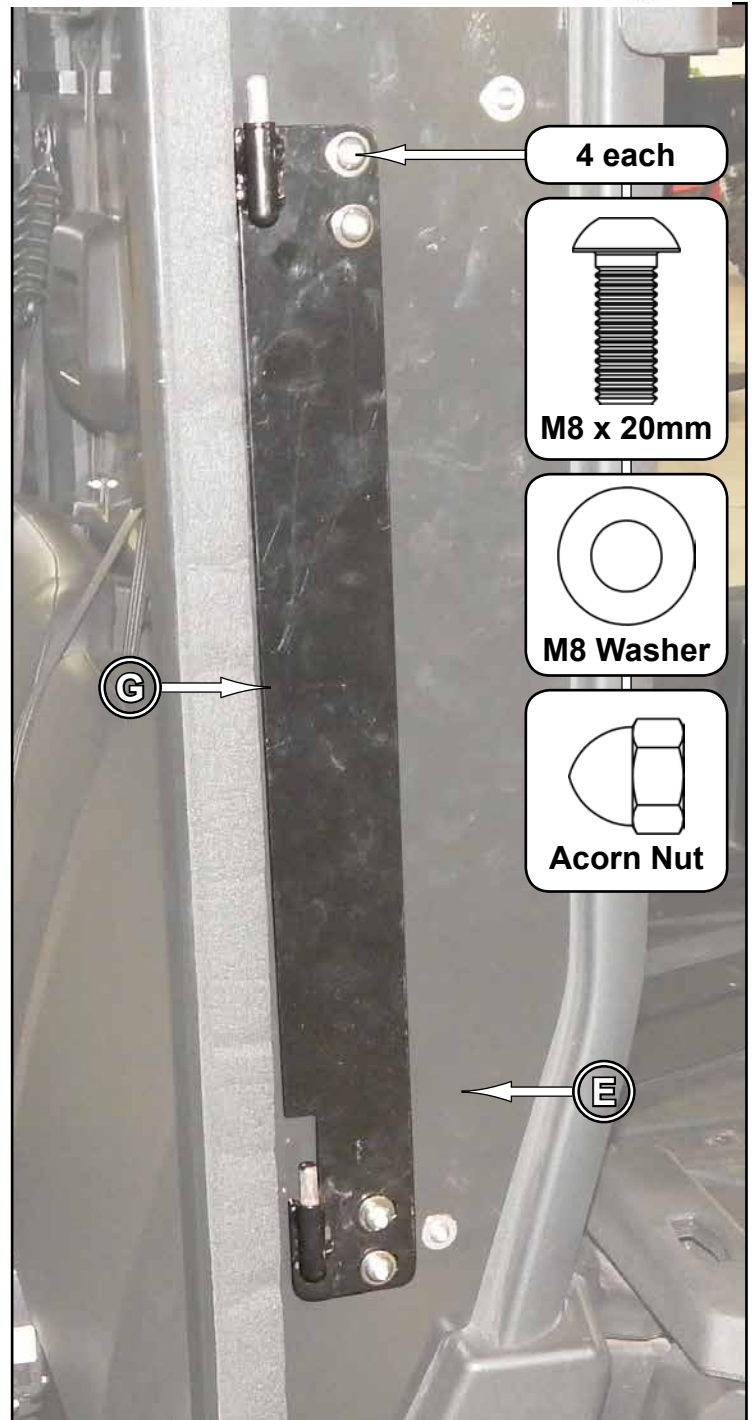
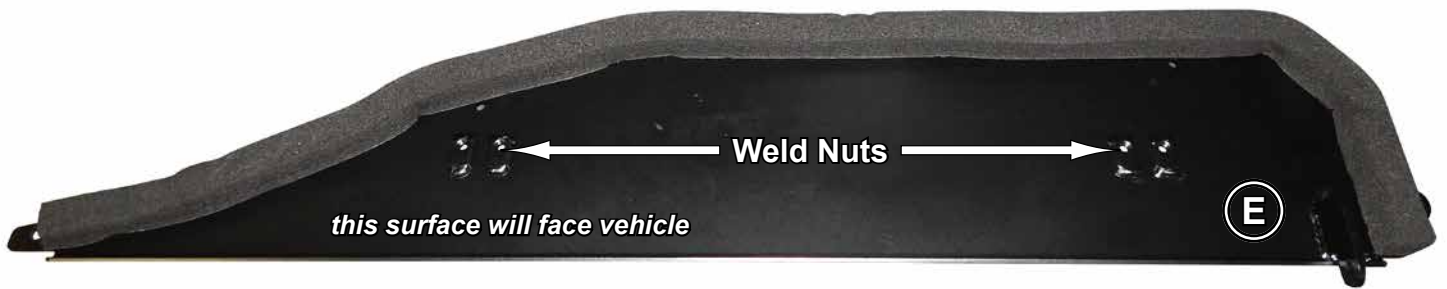

Driver Door Installation continued: do not tighten hardware completely unless noted.

- Install Large Clamps (K) to Driver Hinge Mount (E) with hardware shown. Tighten hardware.
- Install Acorn Nuts onto previously installed hardware.

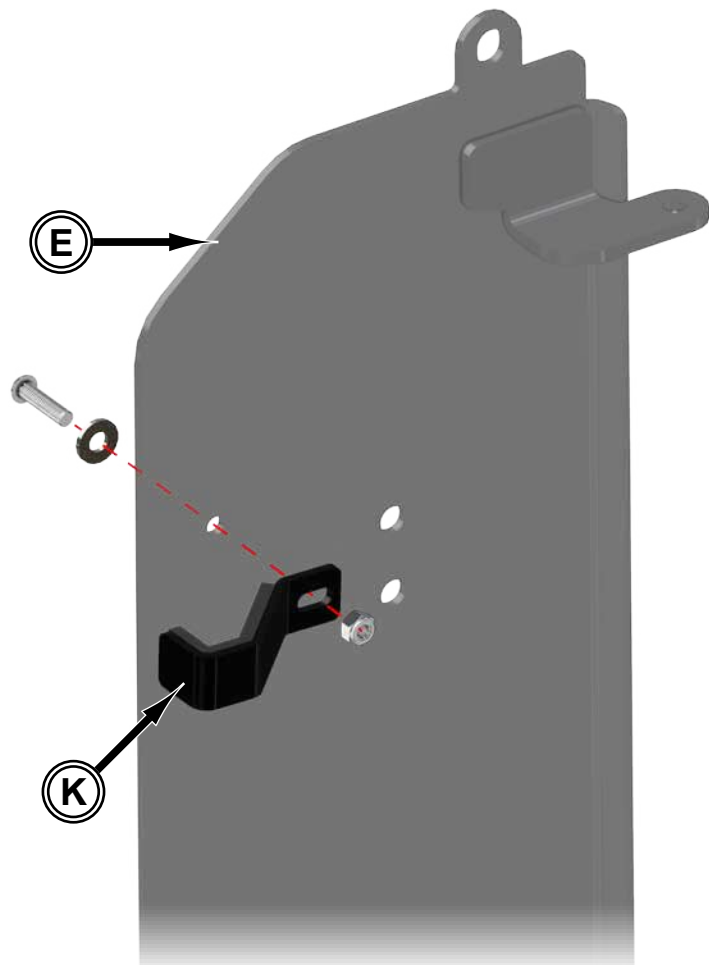
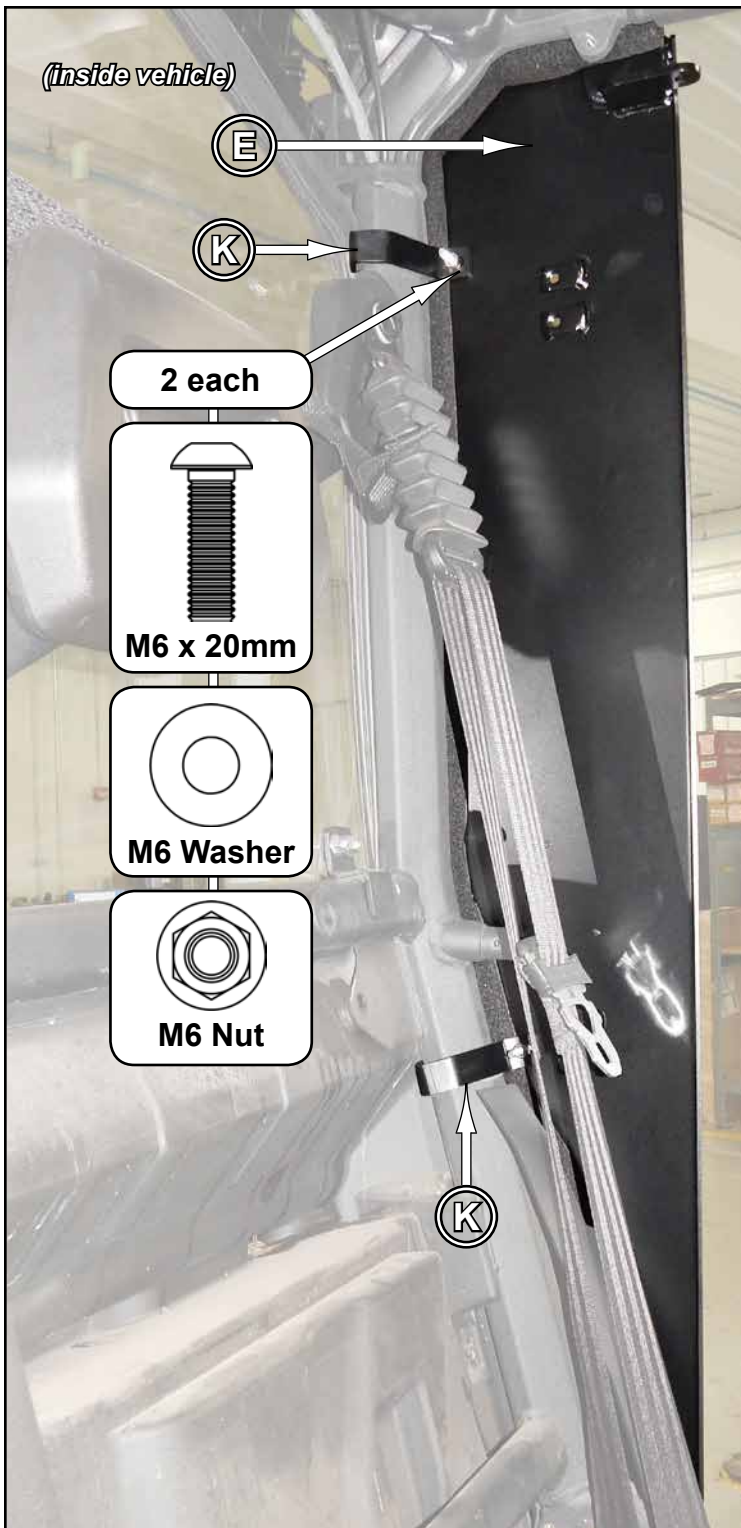

Driver Door Installation continued: do not tighten hardware completely unless noted.

- Install provided "U" Joint to Pillar.

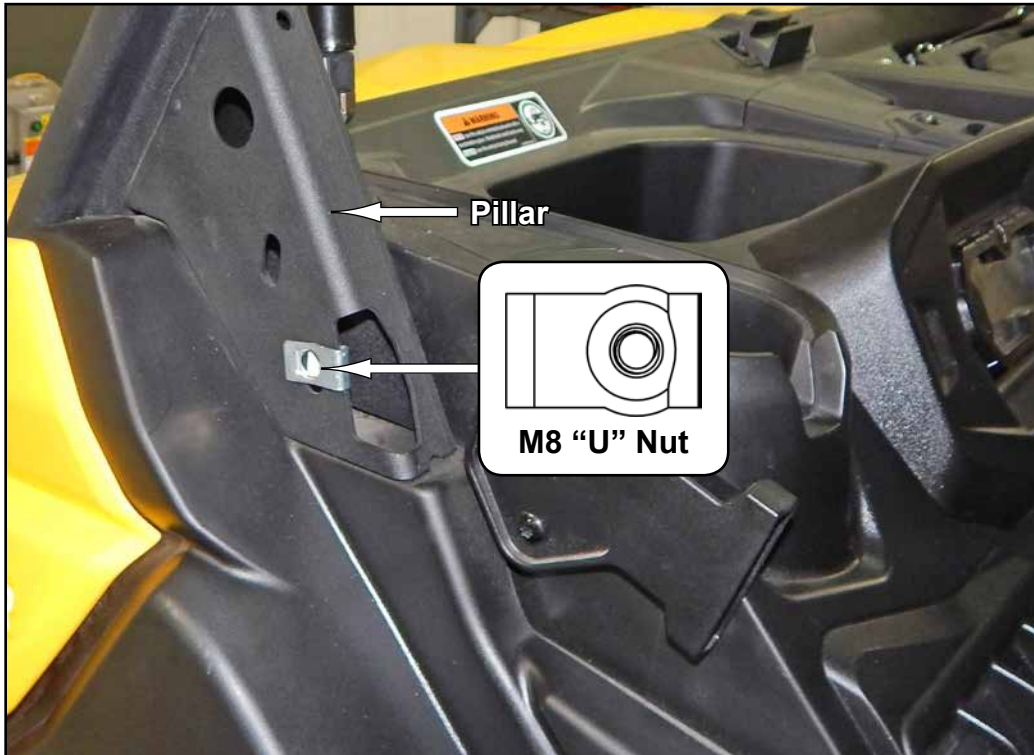

- Secure Pillar Bracket (C) to "U" Nut with hardware shown. Tighten hardware.
- Install Small Clamp (J) to Pillar Bracket (C) and Frame. Tighten hardware.



Driver Door Installation continued: do not tighten hardware completely unless noted.

- Install Striker (B) to Pillar Bracket (C) with hardware shown.

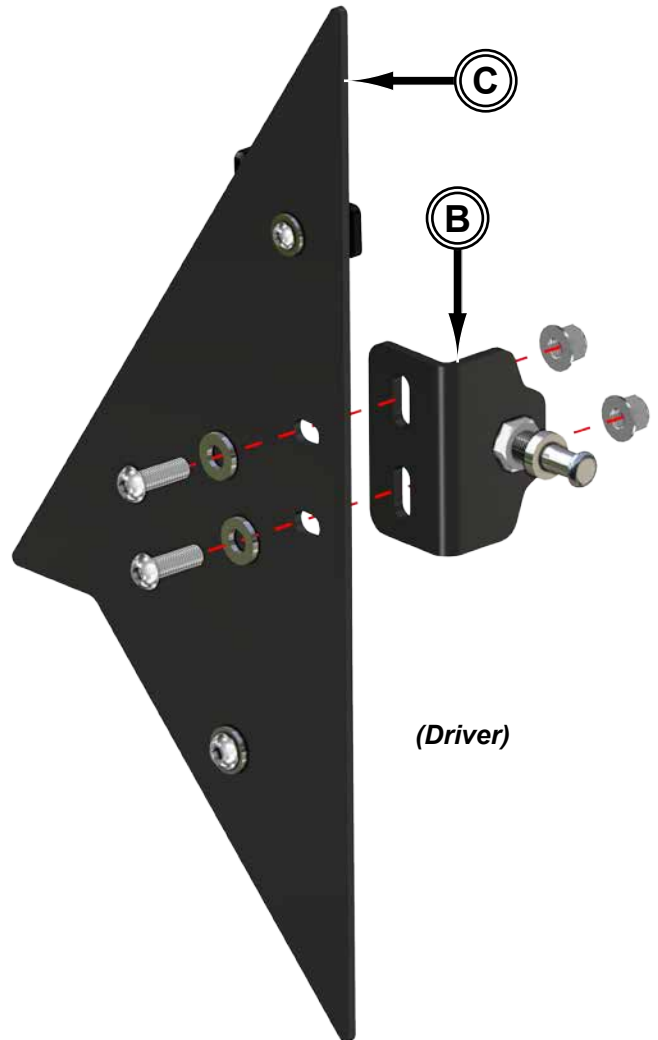
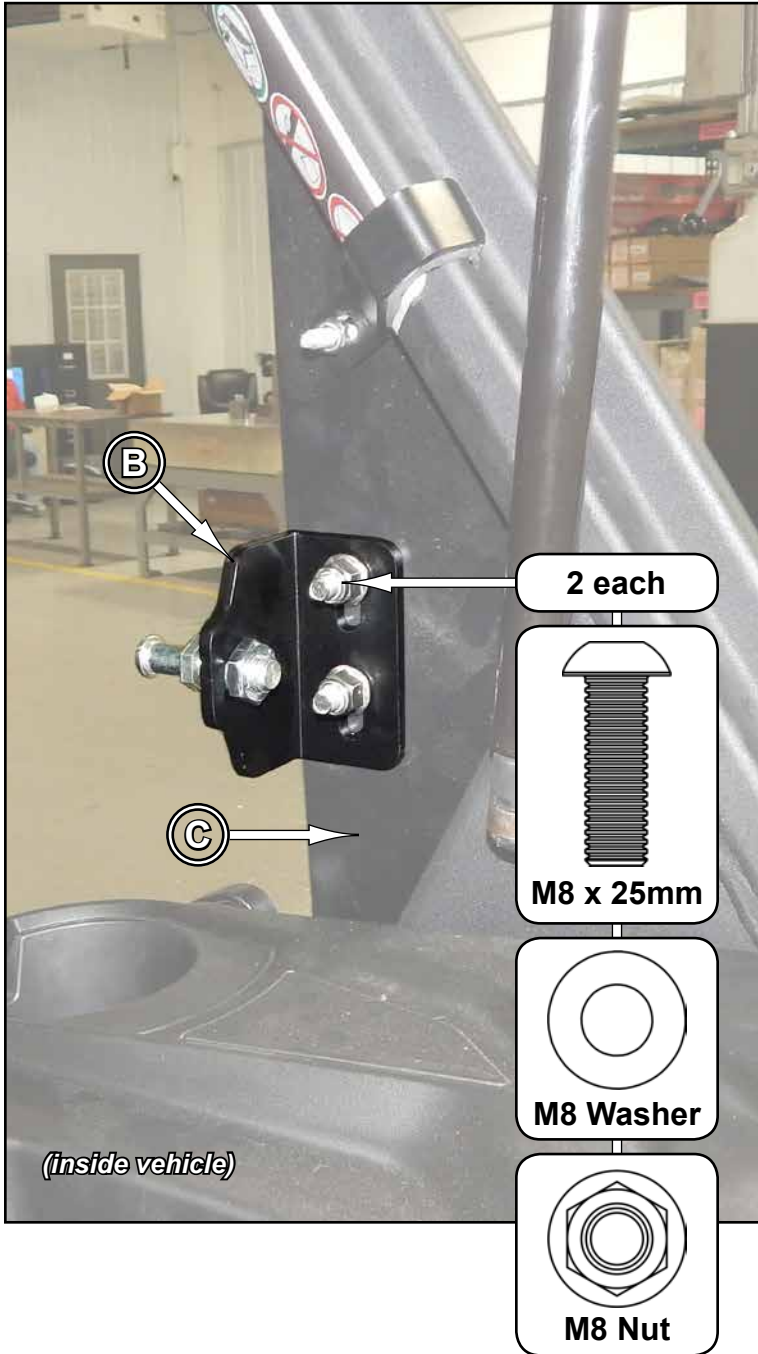

Driver Door Installation continued: do not tighten hardware completely unless noted.

- Install Driver Door (A) onto Driver Hinge Assembly (G).

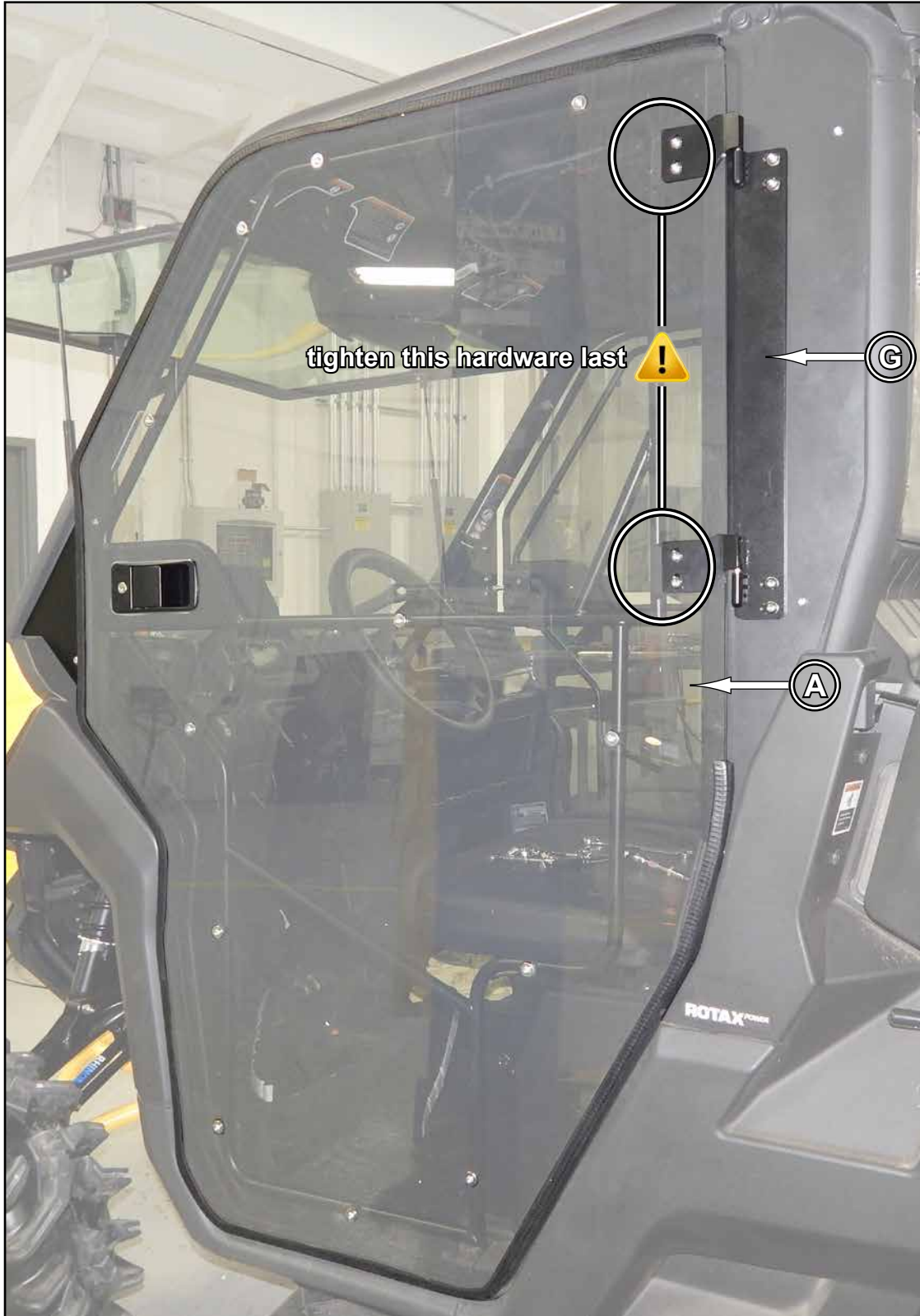

- Close Door, engage Latch / Striker Pin, and align Door to machine.
- Tighten all hardware completely.

Driver Door Installation continued: do not tighten hardware completely unless noted.

- Open Driver Door (A) and install Gas Strut (H) to Driver Door (A) and Driver Hinge Mount (E).
- Secure with hardware shown. Tighten hardware.

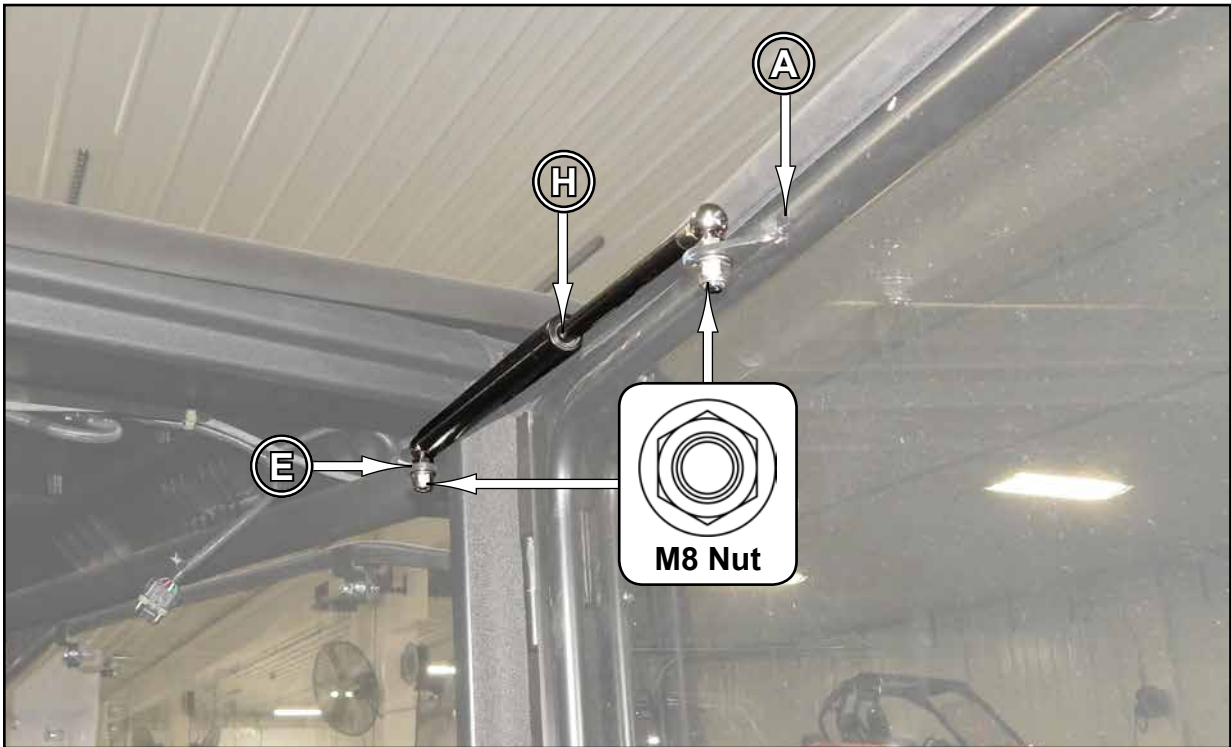

- Remove installed Mounts on Mirrors. Use 8mm wrench. Discard Mount and hardware.

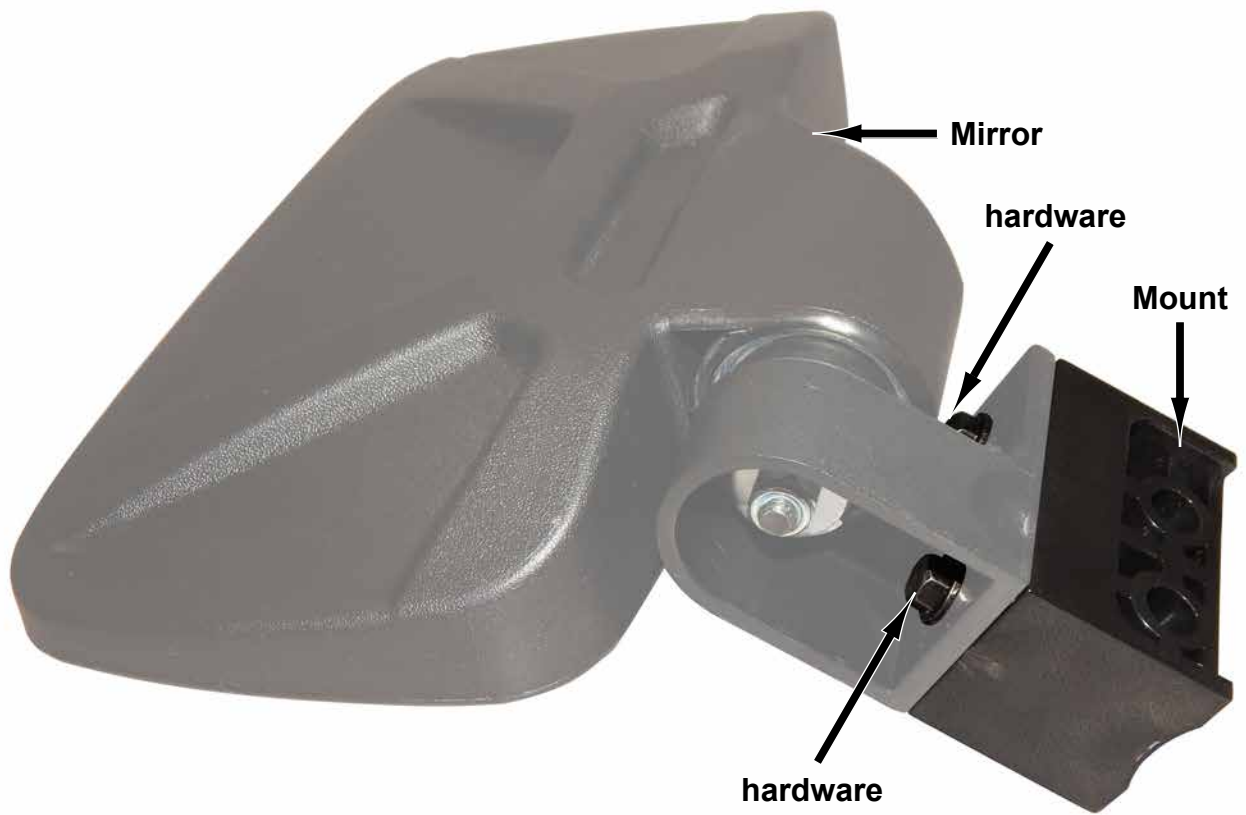

- Install Mirror to Driver Door (A) with hardware shown. Tighten hardware.

