

**INSTALLATION INSTRUCTIONS**  
**Plug and Play Turn Signal Kit:**  
**for Can-Am Defender**

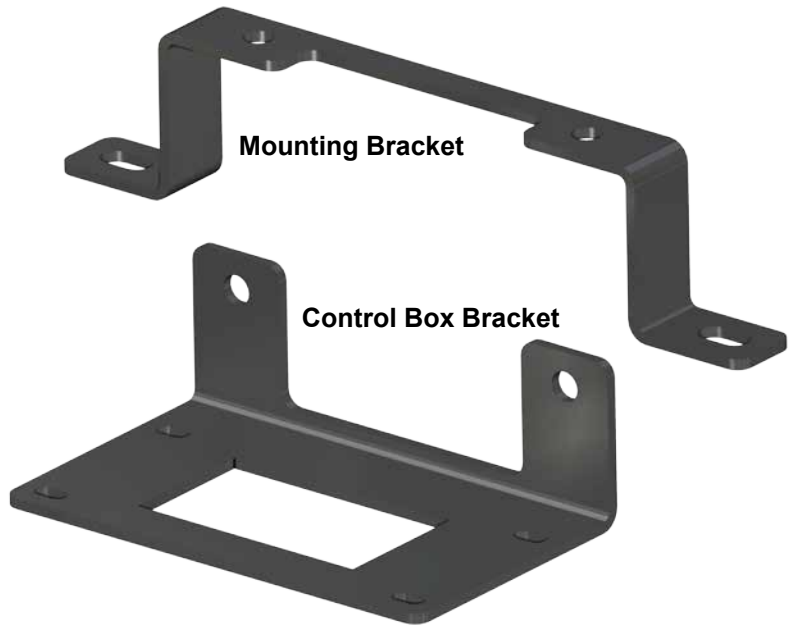

**Horn Kit**



**Mounting Bracket**

**Control Box Bracket**

*(disregard any remaining hardware)*

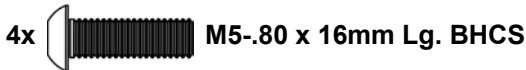
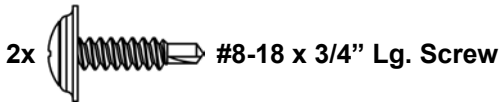
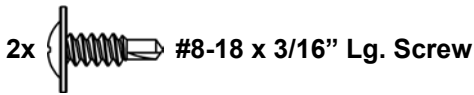

**Hazard Light Switch**



**Horn Switch**



**Turn Signal Switch**



**Wire Ties**

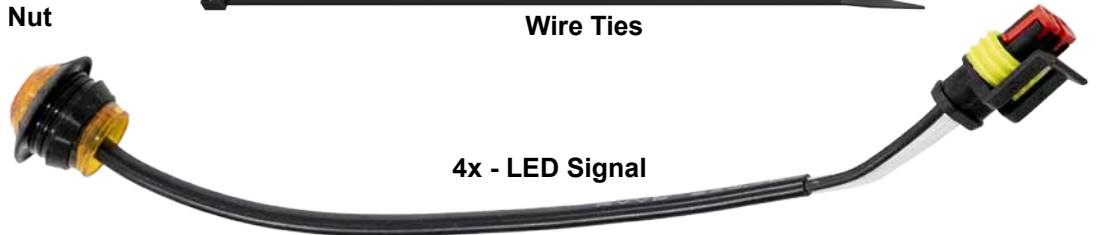

**4x - LED Signal**

*Components may be installed in locations other than where shown. Always verify wire harness length.*

**Need help with your installation?**

 [sales@superatv.com](mailto:sales@superatv.com)
 [www.superatv.com](http://www.superatv.com)

 1-855-743-3427
  8:00am - 9:00pm EST M-Th  
 8:00am - 7:00pm EST Friday  
 9:00am - 2:00pm EST Saturday

**Read instructions and view illustrations before beginning.**

*Thank You*  
*For Choosing*  
**SUPERATV**.COM<sup>®</sup>

**Always consult labels on Wiring Harnesses when making connections.**



**use provided dielectric grease on all connections**

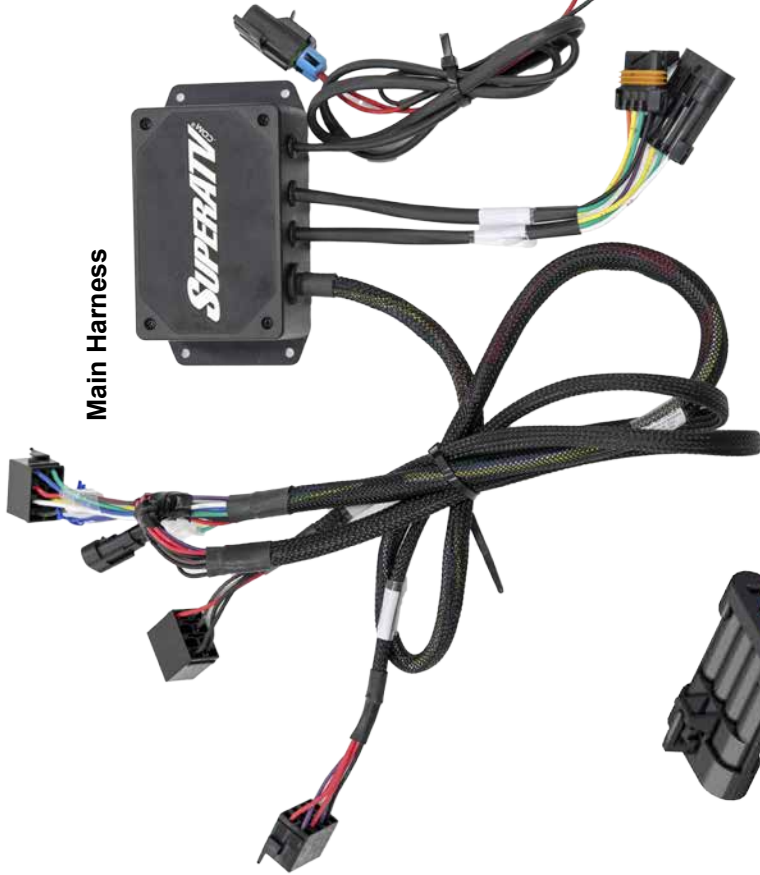

**Main Harness**

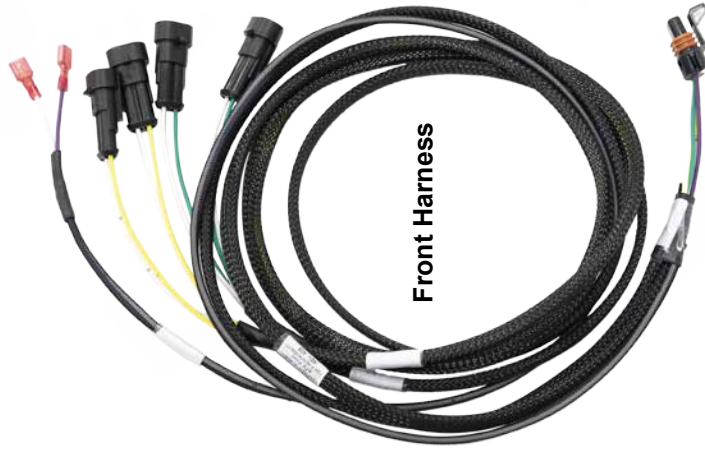

**Front Harness**



**Rear Harness**

- Remove Front Bulkhead Cover.



- Remove Battery Cover.



- Remove Floor Cover.



- Secure Control Box to Bracket with provided M5 hardware.

Control Box Bracket

Control Box

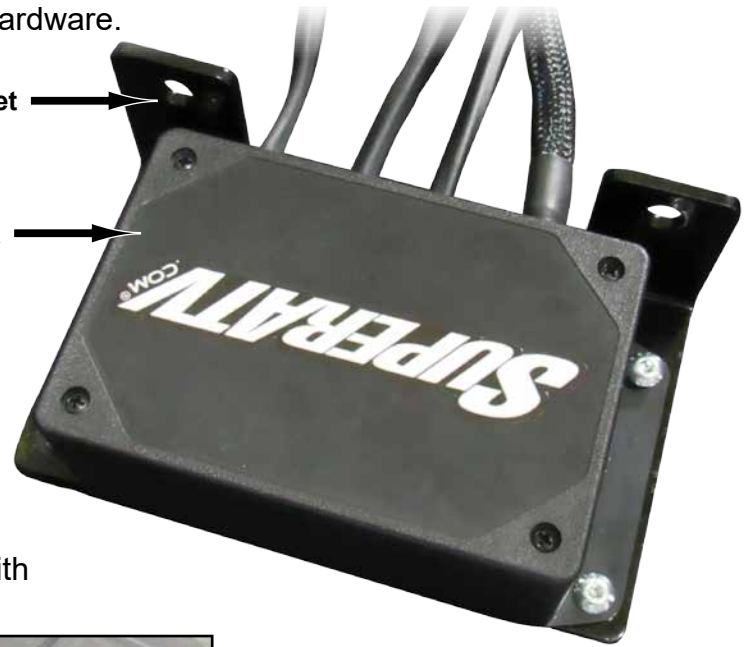

- Join Control Box Bracket and Mounting Bracket with provided M8 hardware; do not tighten completely.

provided M8 hardware

Mounting Bracket



## Wiring Harness:

- Route Harness to Front and Rear of vehicle.

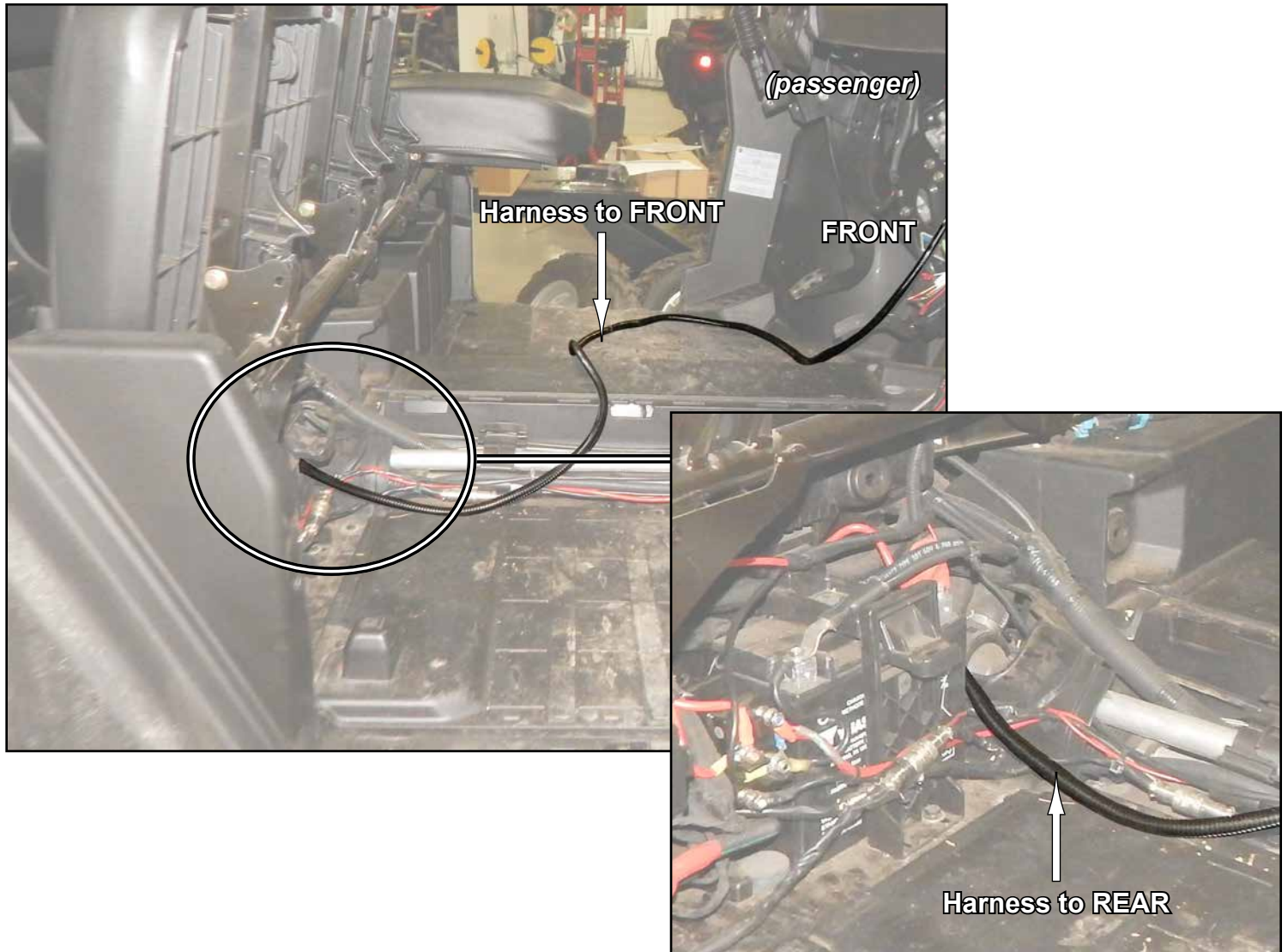

## Power Connections:



connect 12V and Ground wires from  
Harness to Accessory Power Block

*(driver footwell looking under Dash)*

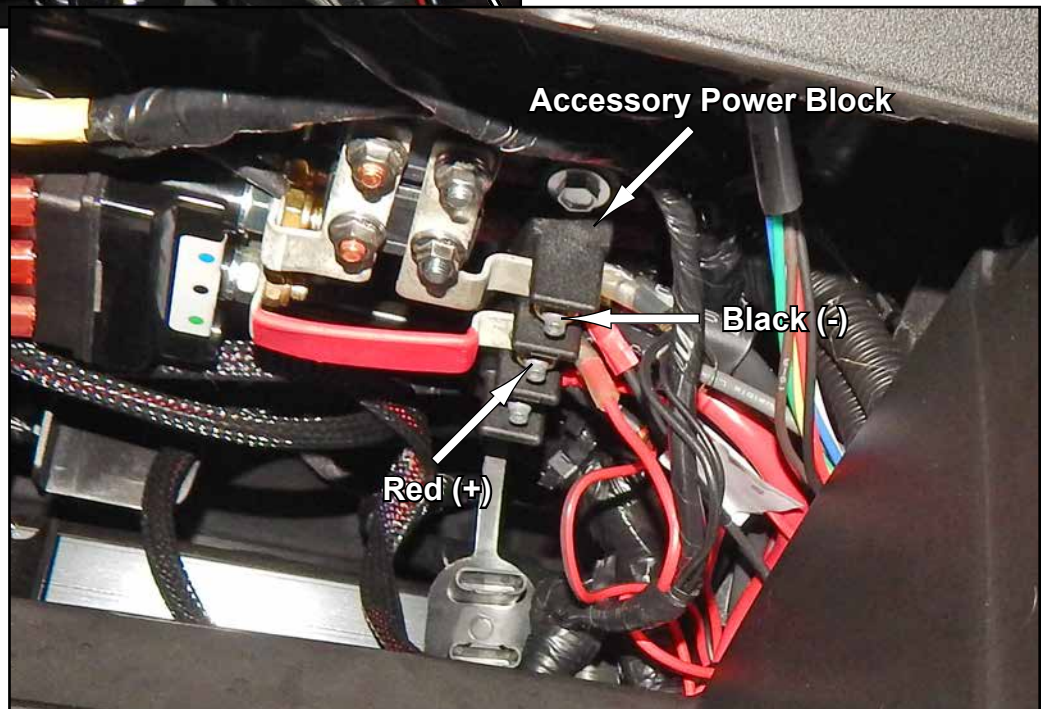

## Horn:

- User may install Horn in location different than shown.
- Location must be protected from mud, debris, and water.
- Illustration is SuperATV's choice.



- Connect Harness and install Horn.
- Secure with Nut provided in Horn Kit.



**Before drilling any holes, check behind area to be drilled for any interference.**

### **LED Signal:**

- Drill a Ø3/4" hole in body and install LED Signal. Repeat for remaining LED Signals.
- Plug LED Signals into corresponding inputs on Front Harness.
- Secure all Wires as needed.

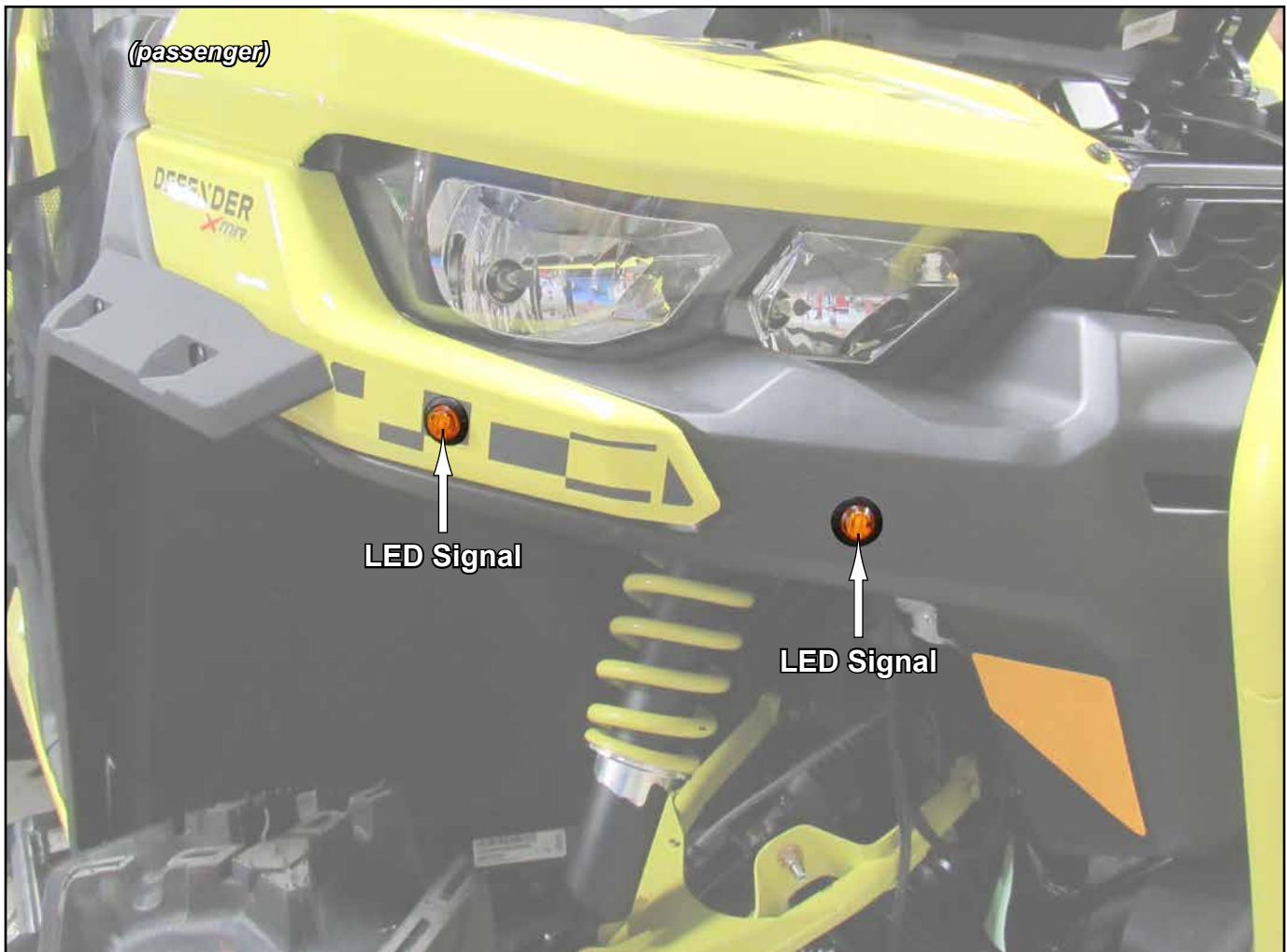

**If Light is hard to insert separate as shown.**

- Separate LED from Gasket.
- Install Gasket into hole.
- Install LED into Gasket.

**Gasket**

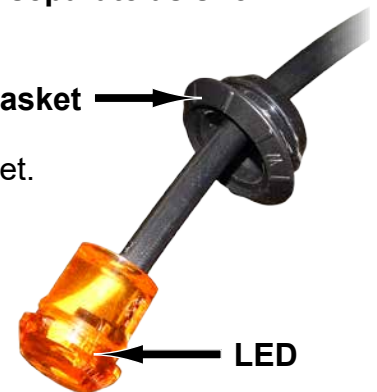

**LED**



- Remove Tail Lights.



## Rear Harnesses:

- Raise Cargo Bed and unplug stock harness in location shown.

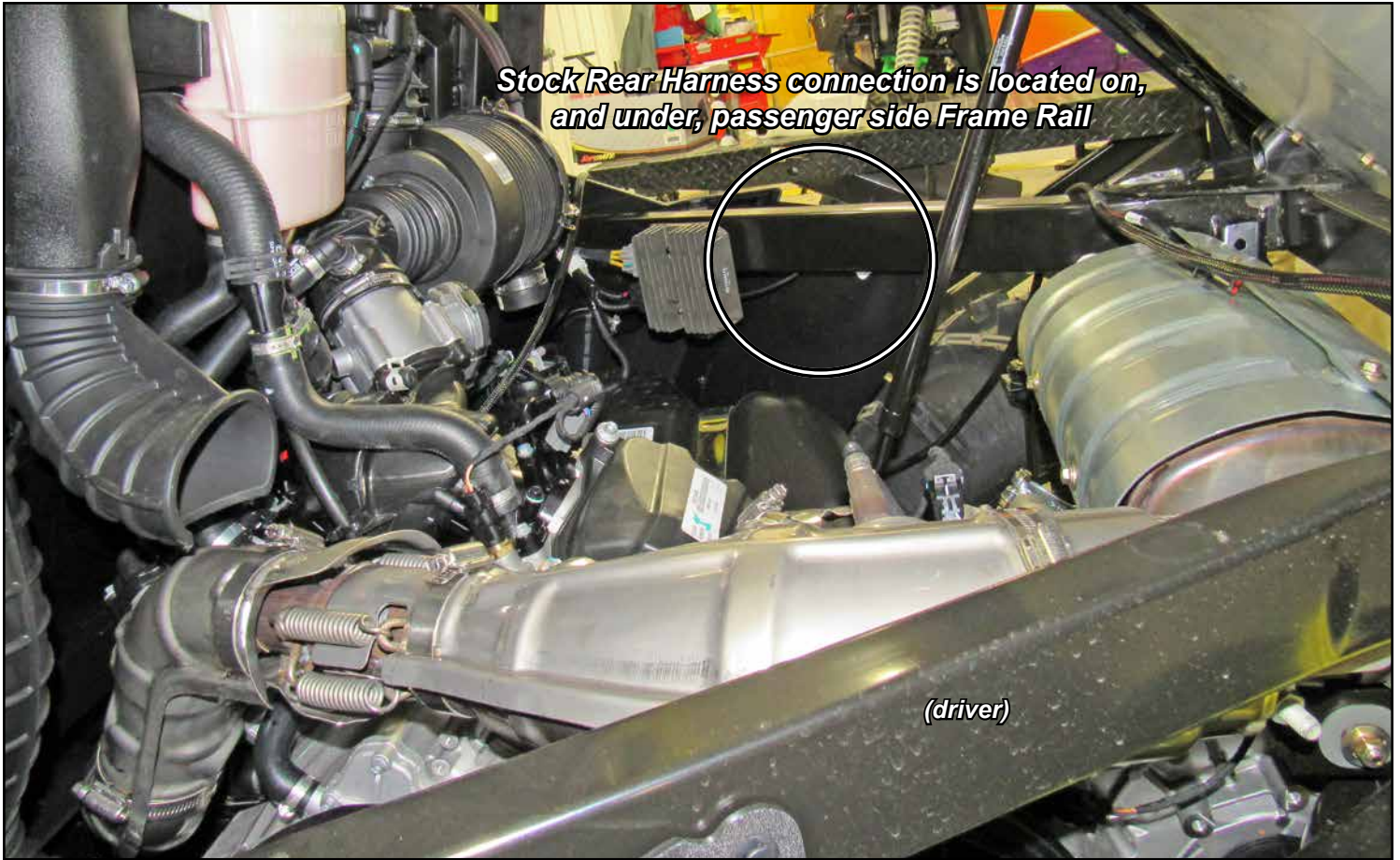

- Connect Rear Harness to stock Harness, as shown, and route to Tail Lights.
- Secure all Wires as needed.



## Switch Orientation

TERMINAL 7 AND ARROW MUST BE ORIENTED AS SHOWN

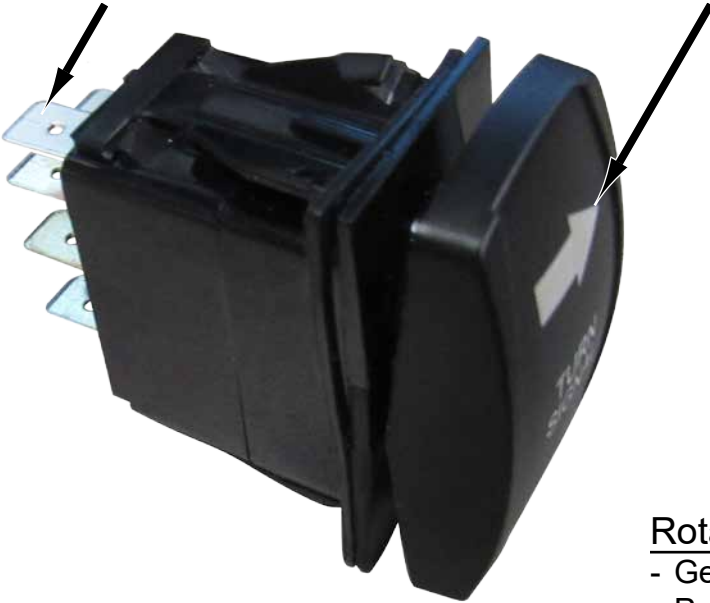

### Rotate Actuator 180°

- Gently pry one side up.
- Pry opposite up and remove Actuator.
- Rotate and snap Actuator into place.



**Before drilling any holes, check behind area to be drilled for any interference.**

**Switch Mounting:**

- User may install Switches in locations different than shown.
- Verify that Wire Harness will reach Switches before mounting.

**SuperATV recommends testing Switches before permanently mounting.**



**if no stock locations are available, use provided template and cut slots for Switch mounting**

- Install Mounting Bracket to Frame with provided M8 hardware; tighten completely.

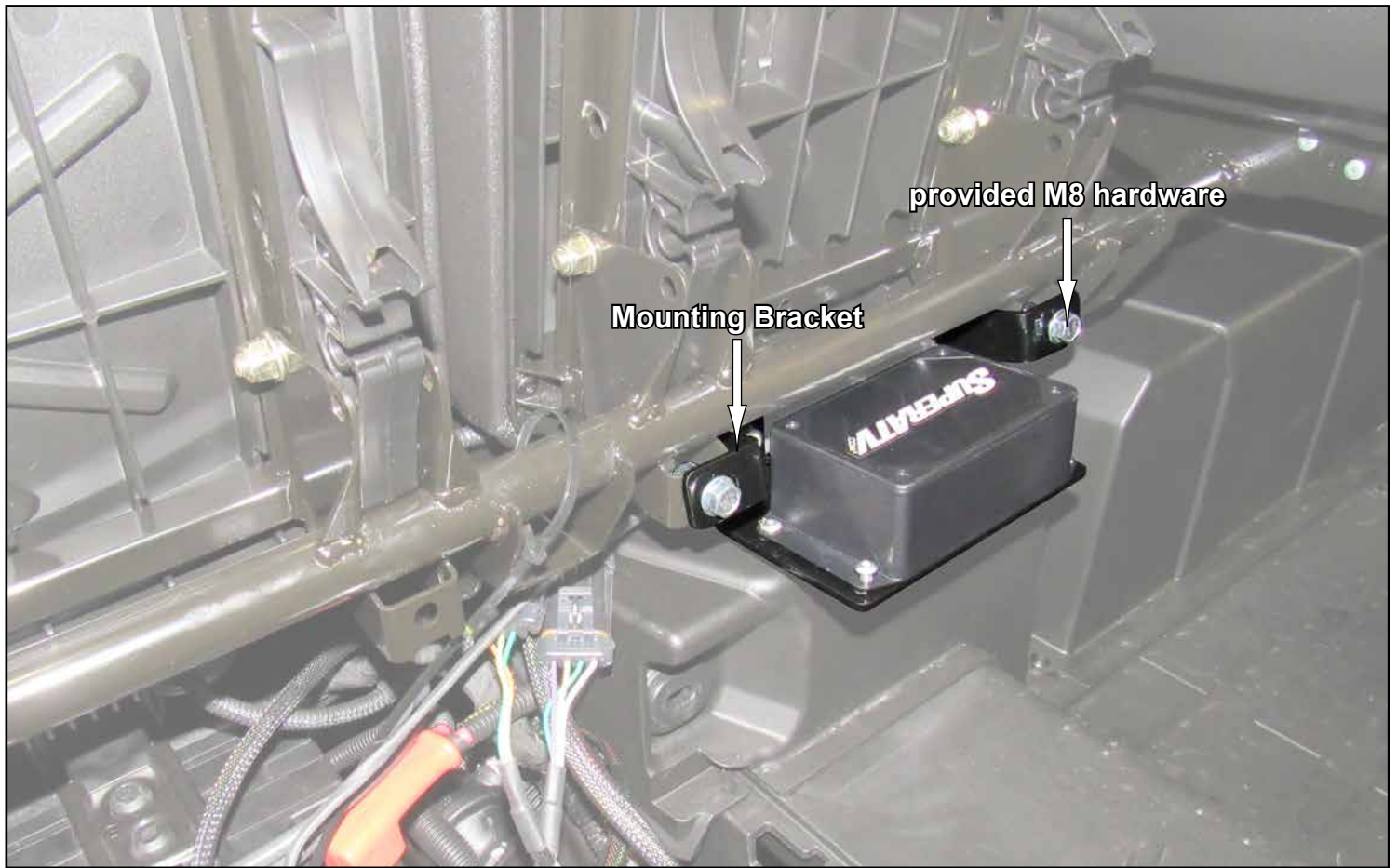

- Reinstall stock components.

- Rear Harness has a connection for License Plate lighting. Connect License Plate Harness and route as needed.



### Switch Templates



#### CUSTOMER NOTIFICATION AND DISCLAIMER LIABILITY

**This product is a modification for utility task vehicles and all terrain vehicles. Use this product at your own risk.**

**Warranty and Liability Limitations.** The Buyer hereby assumes all risks associated with the use and/or installation of this product. Buyer waives all liability claims against SuperATV® of any kind or nature, including, but not limited to, liability for penalties, fines, property damage, personal injury or death, to the fullest extent permitted by law. Buyer acknowledges and agrees that SuperATV® is not liable for any direct, indirect, incidental, consequential or special damages, including but not limited to, damage, loss of life, loss of property or equipment, loss of profits or revenue, injury, or claims from any individual or entity arising from the use of this product.

The warranty for this product, if any, may give you ("Buyer") specific legal rights, and Buyer may also have other rights which may vary from state to state. The installation of this product may void or otherwise adversely affect your factory warranty.

Consult your vehicle warranty before using this Product. Under no circumstances will SuperATV® be liable for the voidance of the Buyer's vehicle warranty. Buyer assumes all risk and responsibility if a manufacturer and/or dealer voids the Buyer's vehicle warranty due to use of this Product.

**Safety and Laws.** Operate your vehicle at all times in a safe manner. You must abide by all local, state, and federal laws, including but not limited to vehicle safety, traffic laws, and ordinances. It is your responsibility to know the laws and how they apply to you. The installation of this product may violate certain local, state, and federal laws. Be advised that laws vary depending on town, city, county, state, etc. Use of this product on public streets, roads, or highways may be in violation law. The Buyer is solely and exclusively legally and personally responsible for any violation of the law by the installation or use of this product. In no case will SuperATV® be held liable if Buyer violates the law or uses the product in an unsafe manner.

The Buyer is responsible to fully understand the capability and limitations of his/her vehicle according to manufacturer specifications, warnings and instructions and agrees to hold SuperATV® harmless from any damage resulting from failure to adhere to such specifications, warnings and/ or instructions. The Buyer is also responsible to obey all applicable federal, state, and local laws when operating his/her vehicle while using this product, and the Buyer agrees to hold SuperATV® harmless from any violation thereof.

**Installation.** The installation of this product on your vehicle indicates that you have had the opportunity to inquire about applicable local, state, and federal laws and ordinances and that you have read and understand, and accept all of the terms of, this Disclaimer.

SuperATV® shall not be responsible for the proper installation, use, and service of this product. Rather, the Buyer shall be solely responsible for the installation of the product and any damage that may be done to the vehicle or vehicle components as a result of modifications made by the Buyer.