

**INSTALLATION INSTRUCTIONS**  
**Roof:** for Polaris Ranger Crew<sup>®</sup> XP 900

Item	Description
A	Front Plate
B	Rear Plate
C	Middle Plate
D	Rear
E	Front
F	Right Panel
G	Center Panel
H	Left Panel

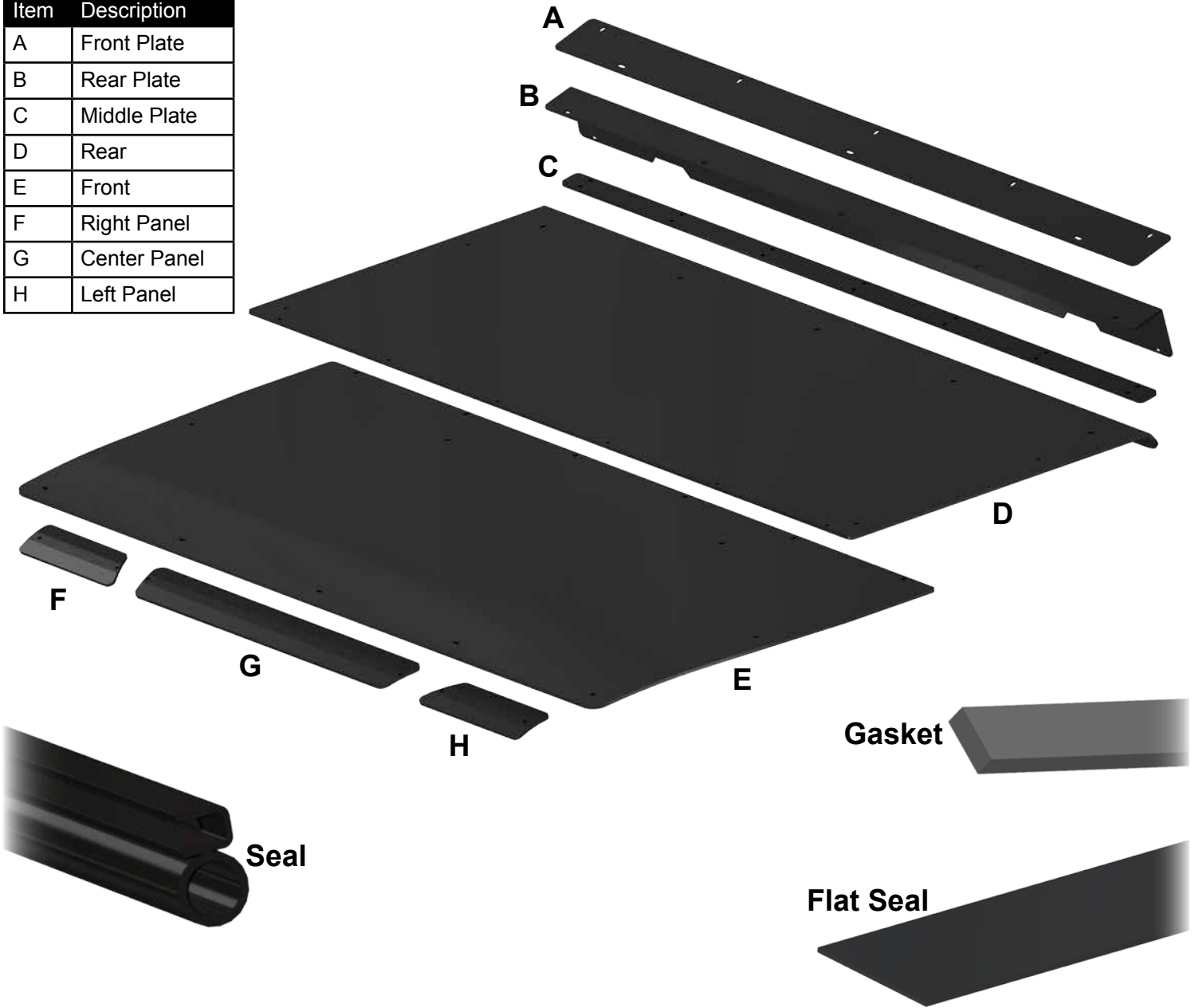

*(Kit Contents continue on following pages)*

**Need help with your installation?**

 [sales@superatv.com](mailto:sales@superatv.com)
 [www.superatv.com](http://www.superatv.com)

 1-855-743-3427
  8:00am - 9:00pm EST M-Th  
 8:00am - 7:00pm EST Friday  
 9:00am - 2:00pm EST Saturday

**Read instructions and view illustrations before beginning.**

*Thank You*  
*For Choosing*  
**SUPERATV**.COM<sup>®</sup>

(Kit Contents continued)

2x  M5-.80 x 20mm Lg. BHCS

12x  M6 Acorn Nut

21x  M6-1.0 x 20mm Lg. BHCS

2x  M5 Flat Washer

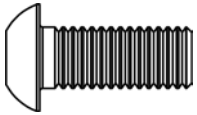
2x  M8-1.25 x 20mm Lg. BHCS

18x  M6 Lock Washer

25x  M6-1.0 x 25mm Lg. BHCS

8x  M6 Flat Washer

2x  M5-.80 Nylock Nut

2x  M8 Flat Washer

28x  M6-1.0 Nylock Nut

2x  M8-1.25 Nylock Nut

37x  M6 Sealing Washer

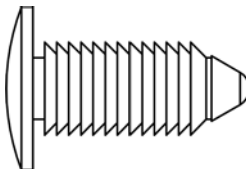
4x  Ø10 x 27.5mm Lg. Shank

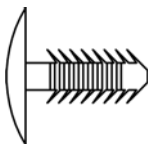

**Rubber must face Roof when installing M6 Sealing Washer**

3x  Ø1/4" x 5/8" Lg. Shank

*Use hand tools only when assembling.*

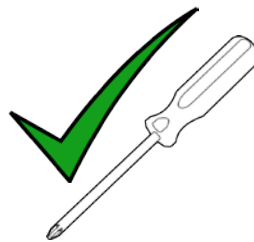

**Do not use power tools.**

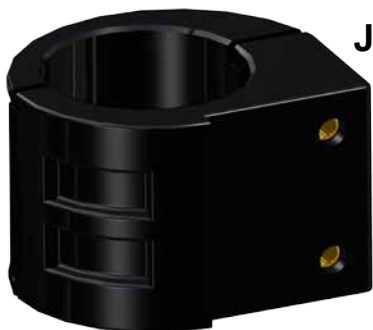

**Clamps are pre-assembled.  
Separate and set aside.**



Item	Description	Qty
J	Clamp	2
K	Bracket	6
L	Middle Mount Bracket	2

(Disregard any remaining components)

**Cleaning:**

- Do not use window cleaning fluids (Windex, 409, etc) or any solvents (gasoline, denatured alcohol, acetone, etc).
  - Never use abrasive cleaners, abrasive pads, or gritty cloths.
  - Never use razor blades, scrapers, squeegees, brushes, etc.
1. Thoroughly rinse Roof to float off dirt and mud.
  2. Using a soft cloth, or microfiber cloth, clean Roof with warm water and a gentle detergent. Baby shampoo or hand washing soap are recommended.
  3. To prevent water spots, use a chamois to blot Roof dry.

**Seal and Gasket installation:** *set aside when completed.*

- Install provided Flat Seal to Front Plate (A), Rear Plate (B), and Middle Plate (C).

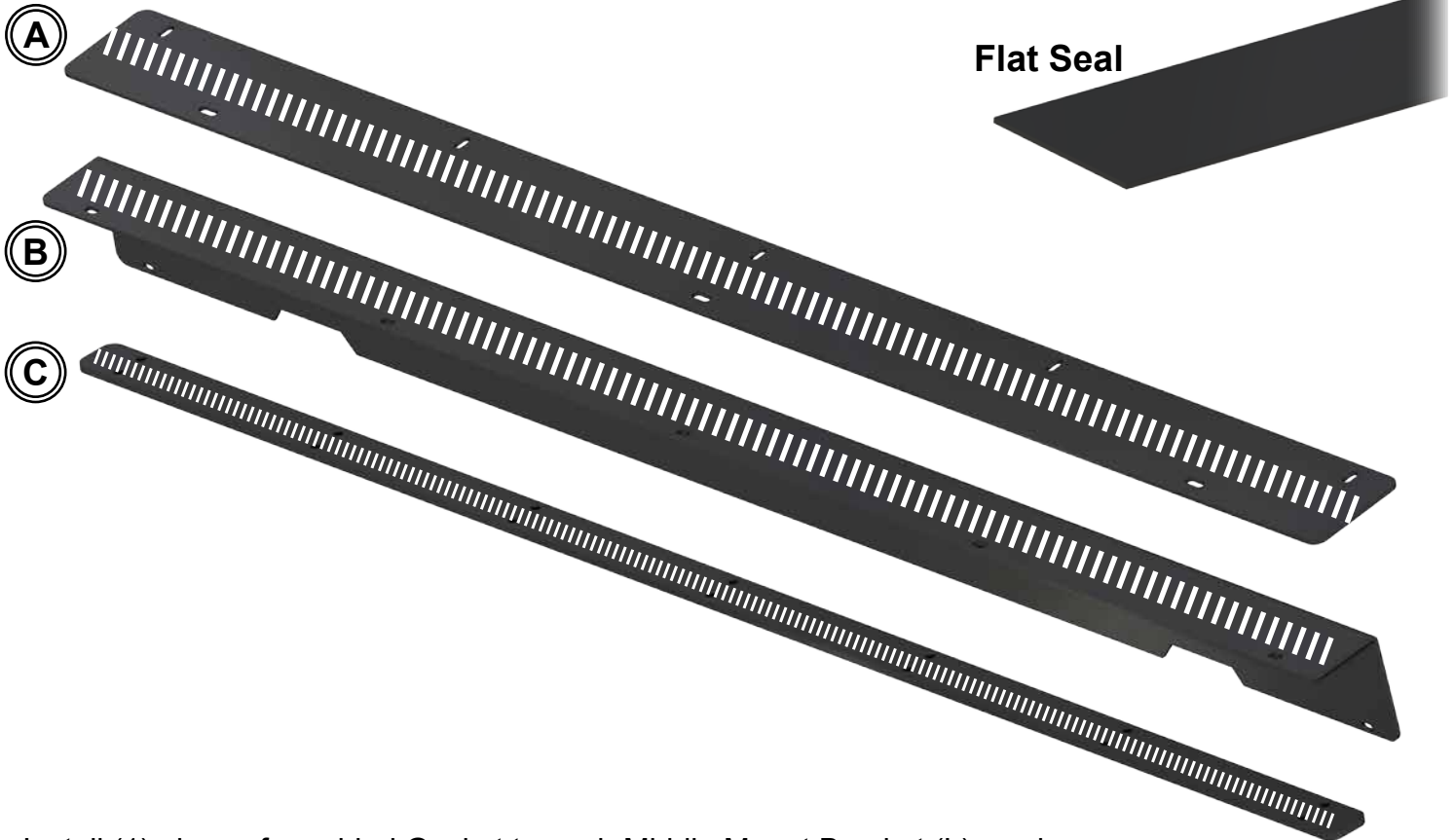

- Install (1) piece of provided Gasket to each Middle Mount Bracket (L) as shown.

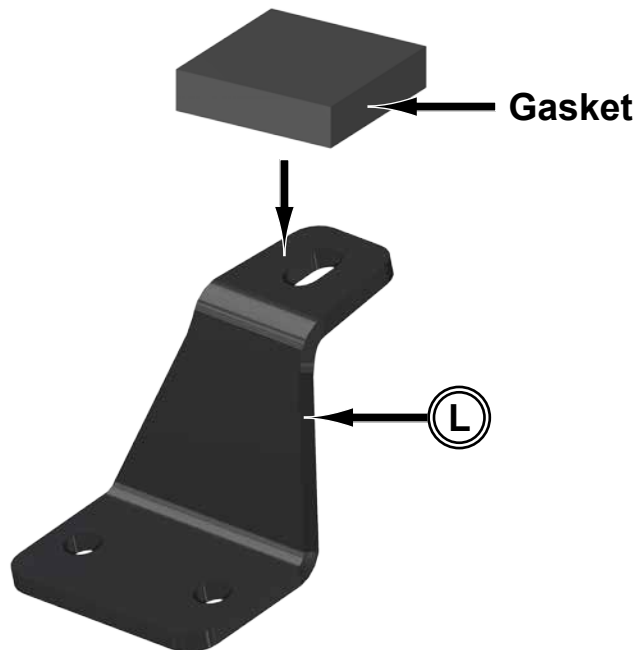

**Panel prep:** *set aside when completed.*

- Place Panel onto Frame and align with stock hole.
- Mark and drill new hole. Hole should be large enough for Ø6mm bolt.
- Repeat for all Panels.
- **NOTE:** *Center Panel location on Frame will not have a stock hole to locate.*

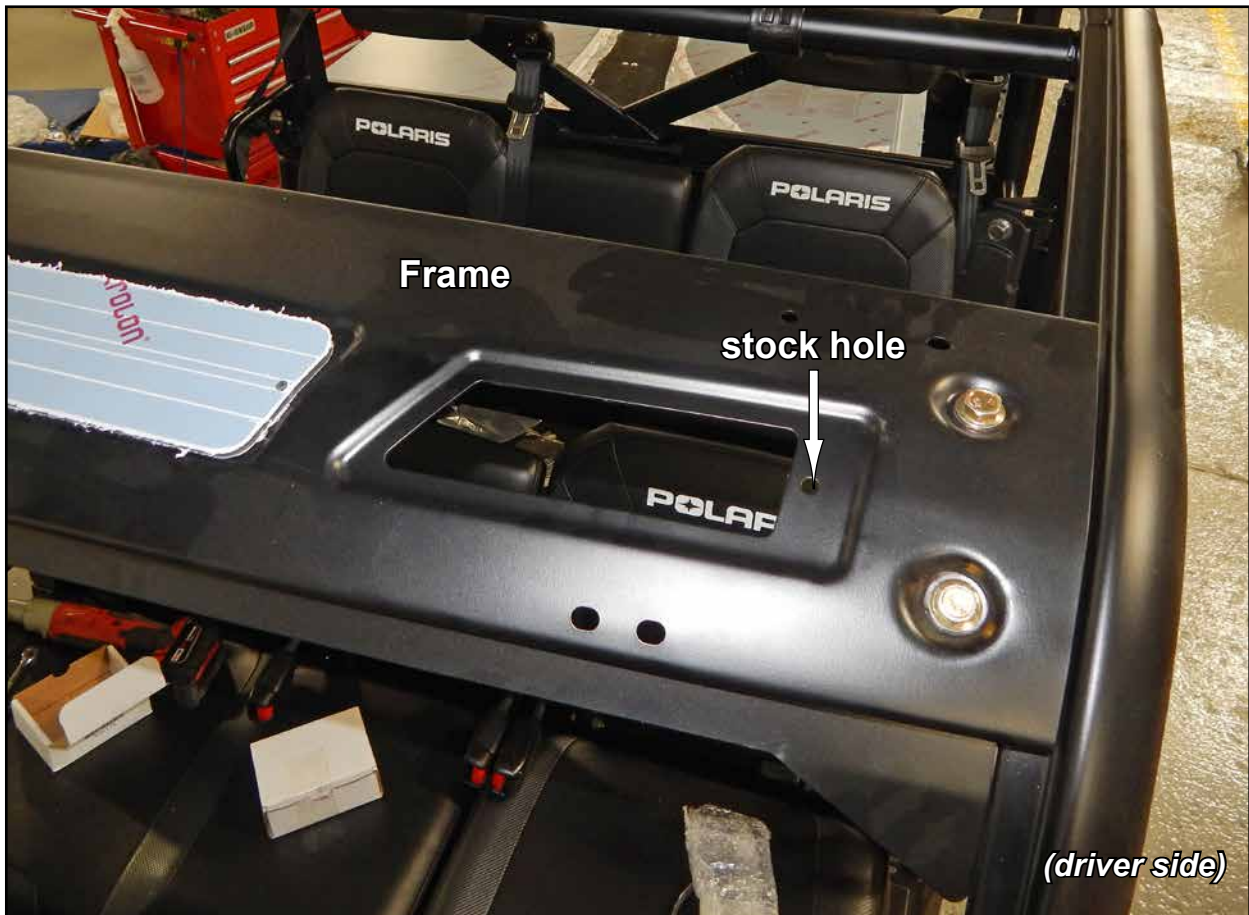
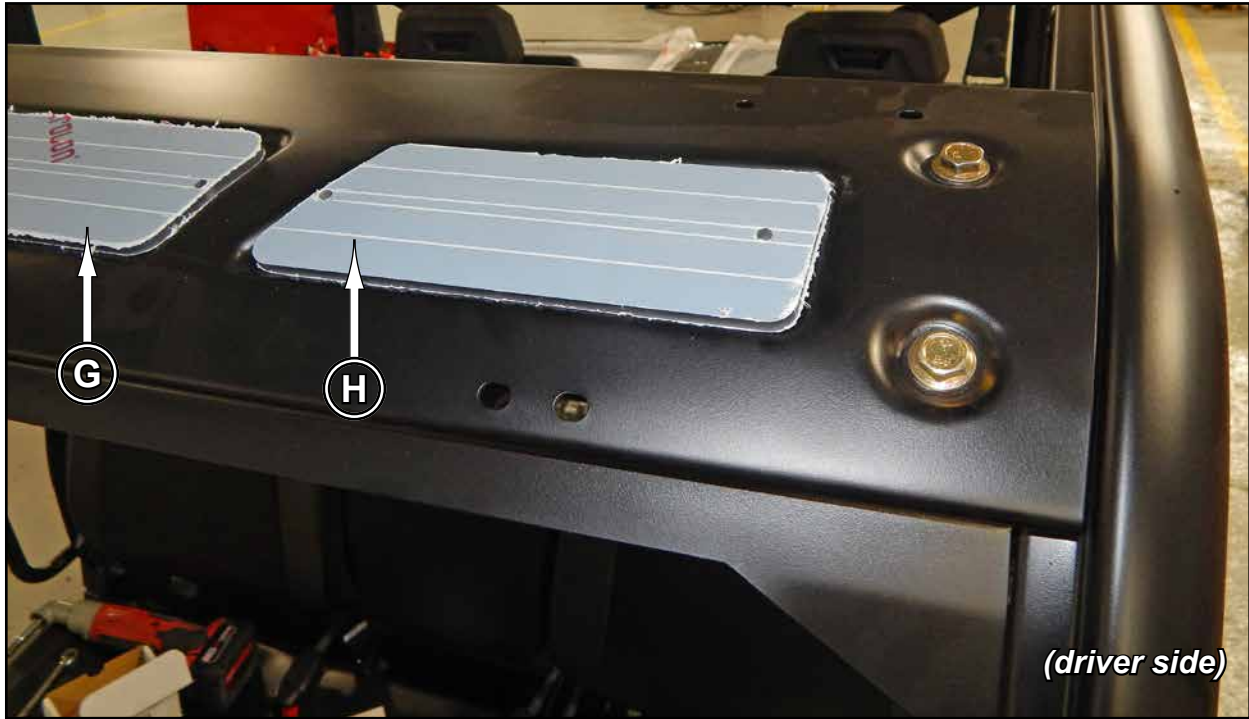

Use hardware shown when installing.

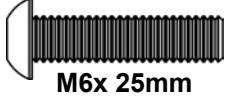

**Panel installation:** *set aside when completed.*

- Install provided Gasket around edges of all cutouts.
- Install Panels with hardware shown.

Gasket

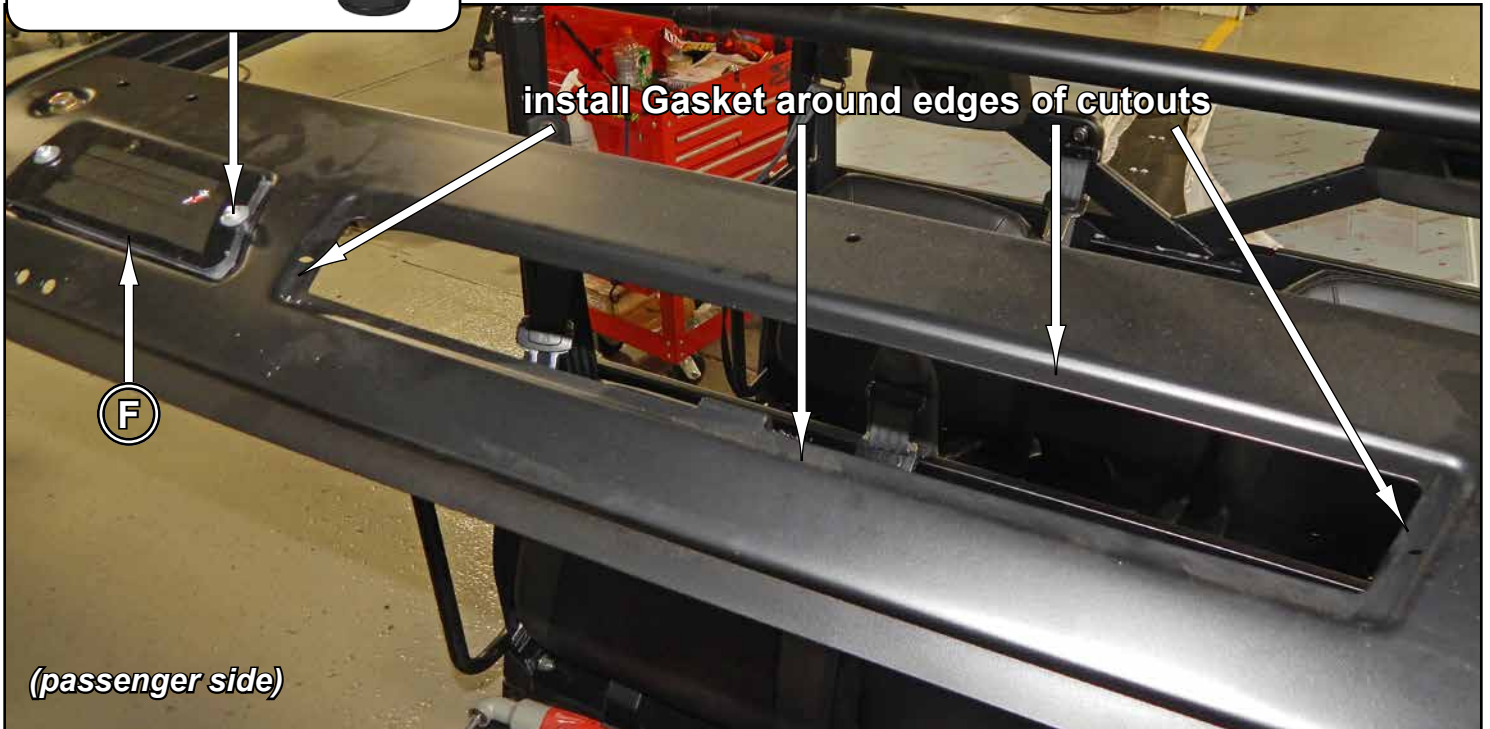

- Plug holes in Frame with provided Shanks. Not all models will use supplied quantities.

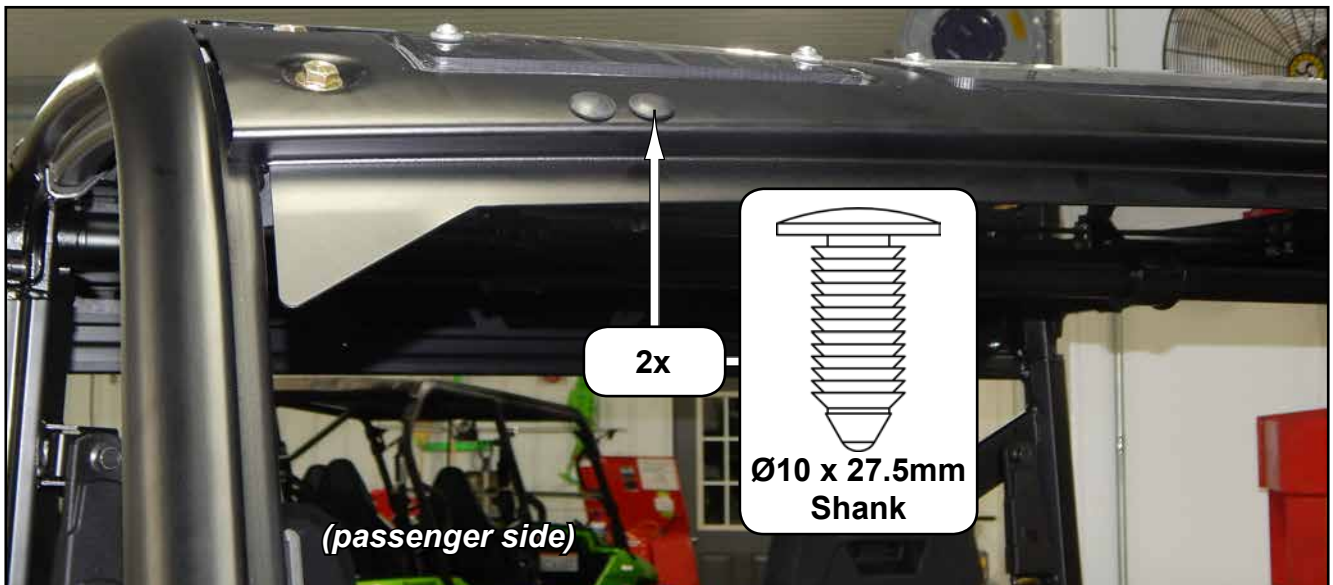

**When installing components, do not tighten any hardware completely unless noted.**

- Install Clamps (J) to Center Bar of machine with hardware shown.

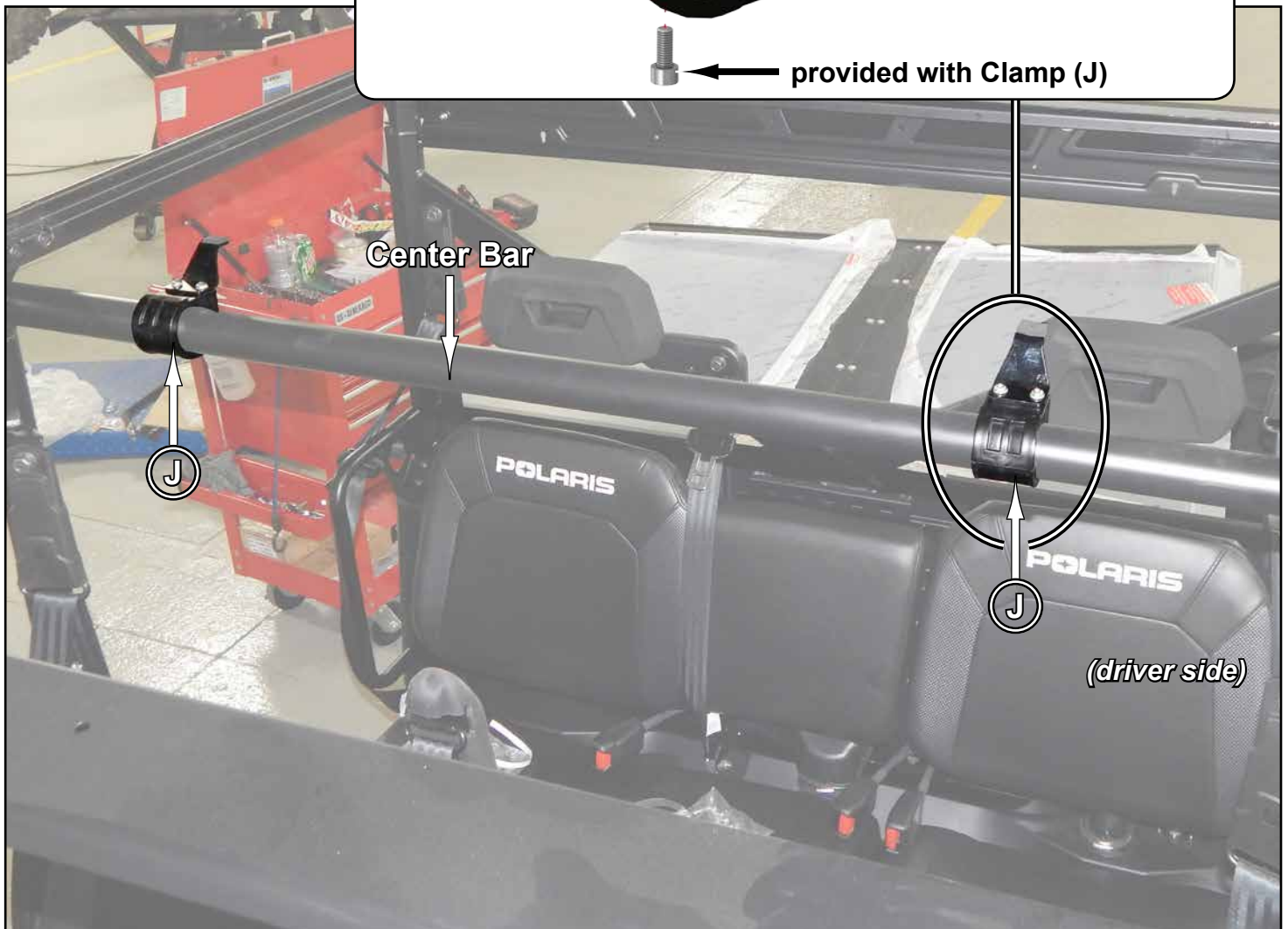
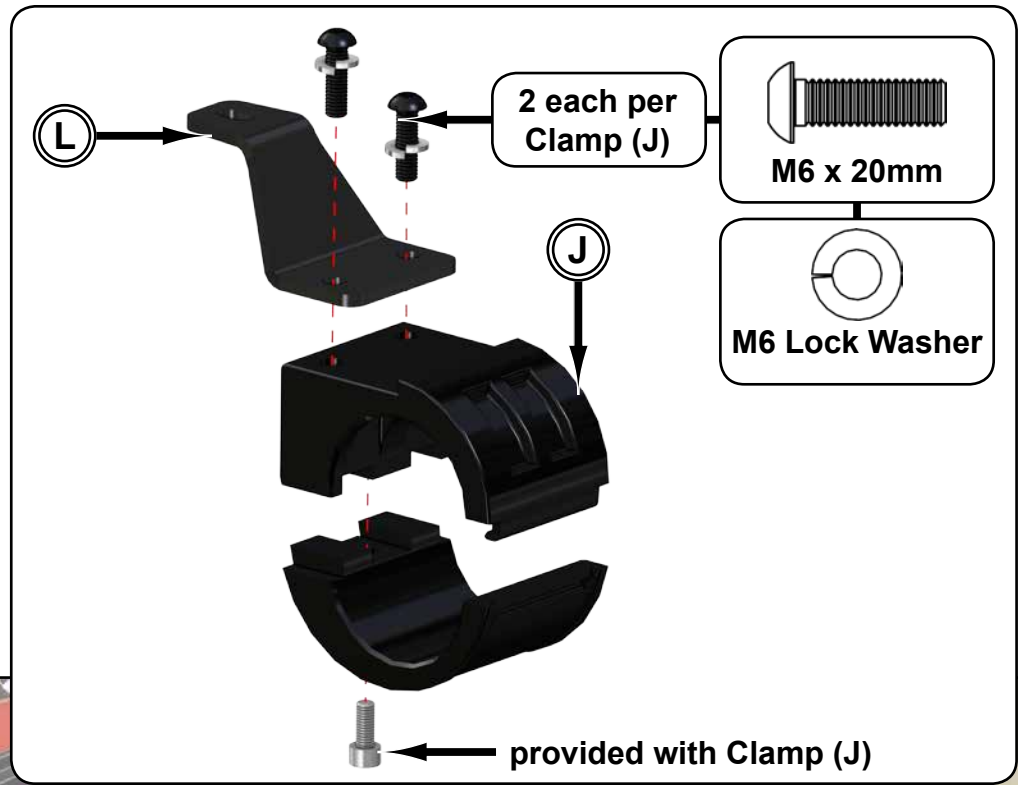

- Install Rear Plate (B) to machine with hardware shown.



**(B)** *(passenger side)*

2 each

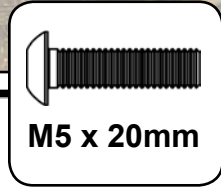

M5 x 20mm



M5 Washer



M5 Nut



M8 Nut

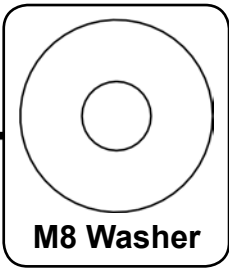

M8 Washer

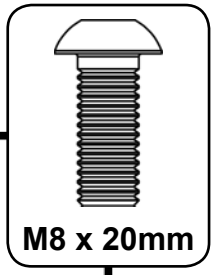

M8 x 20mm

2 each

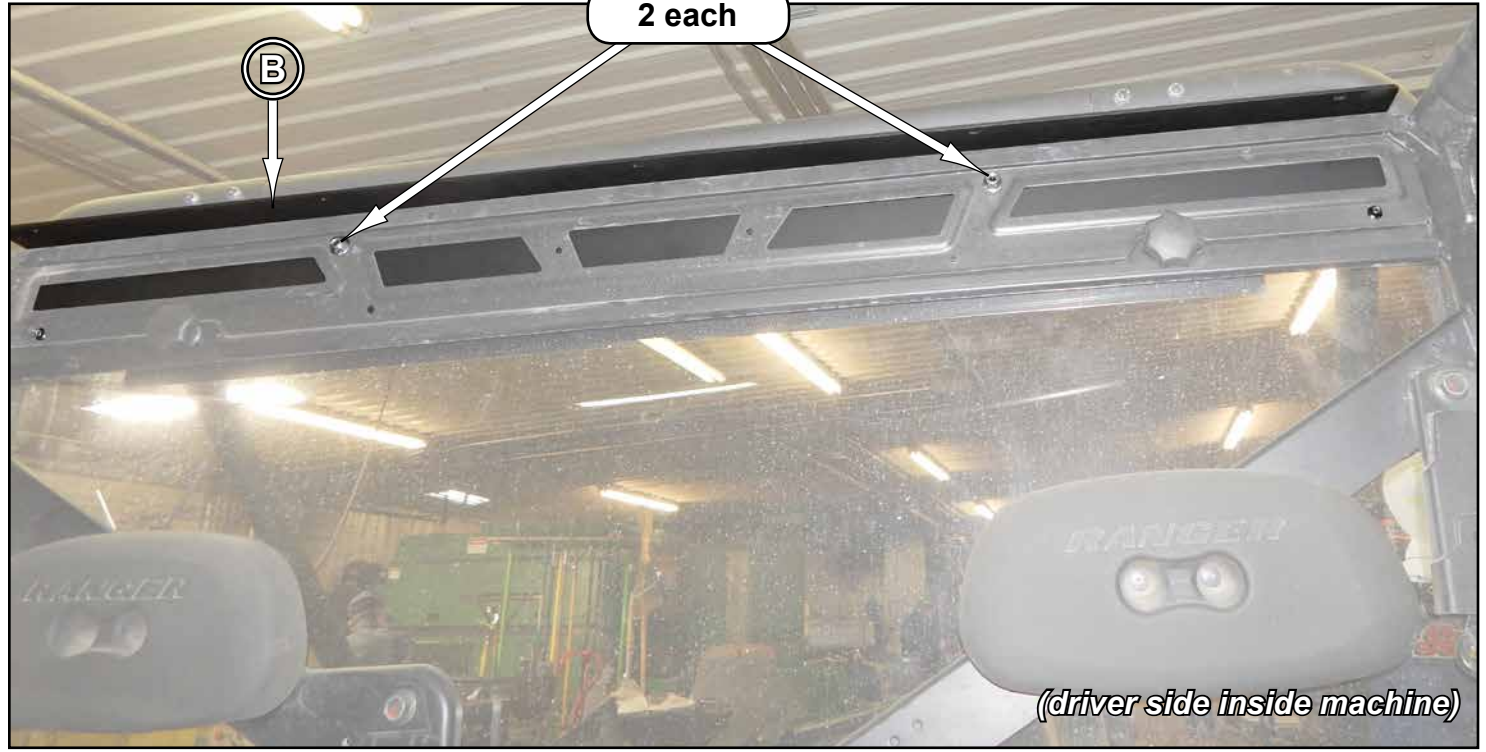

**(B)**

*(driver side inside machine)*

- Install Front (E) and Rear (D) to Middle Plate (C).

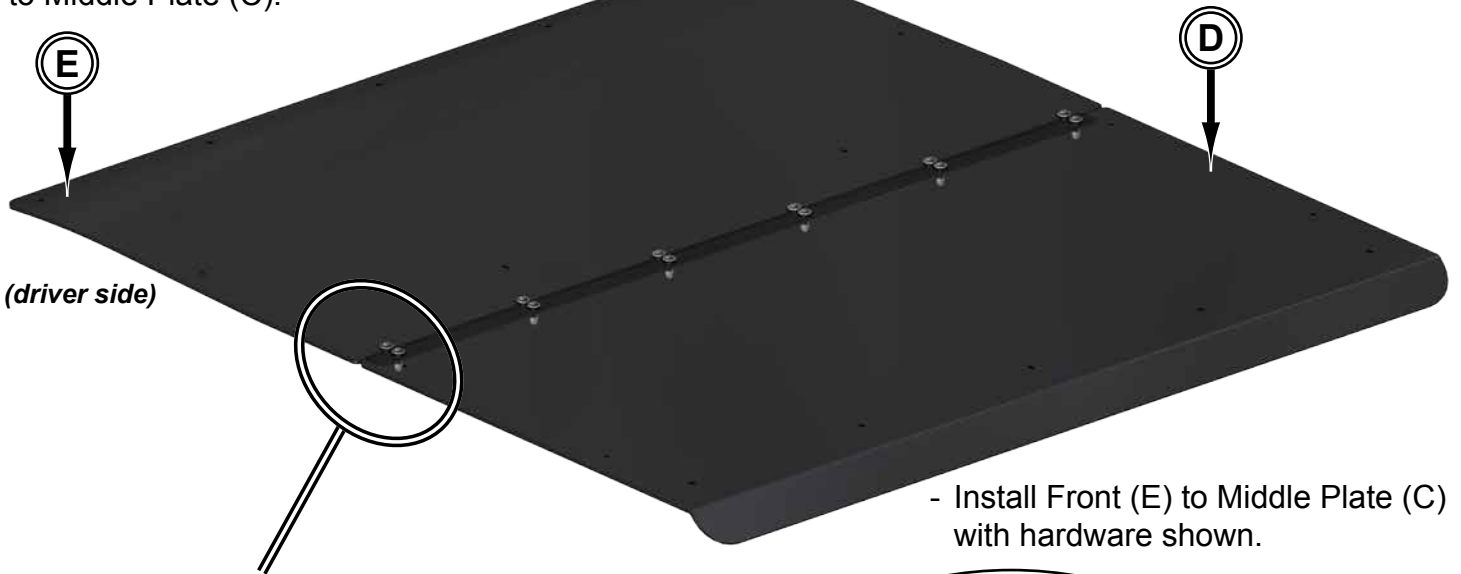

Use hardware shown when installing.

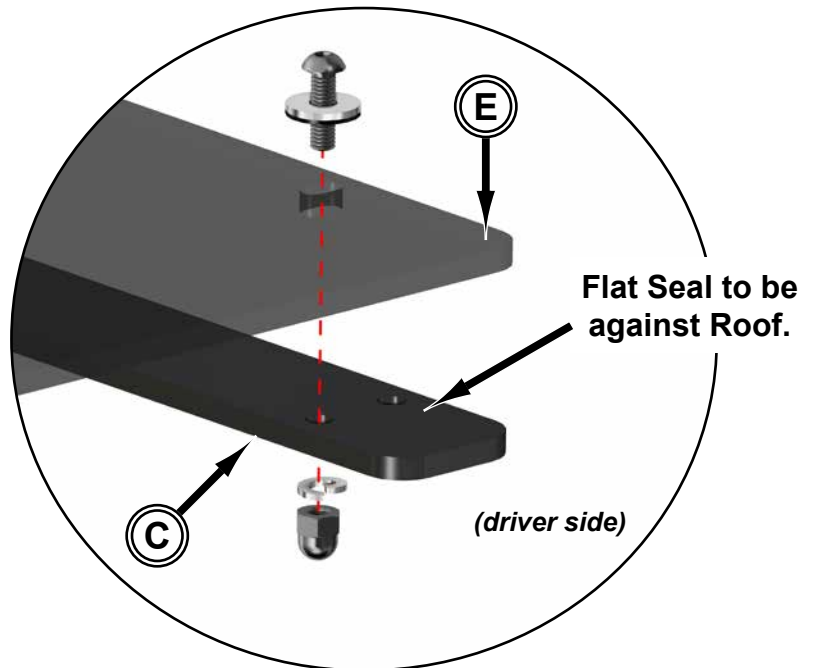
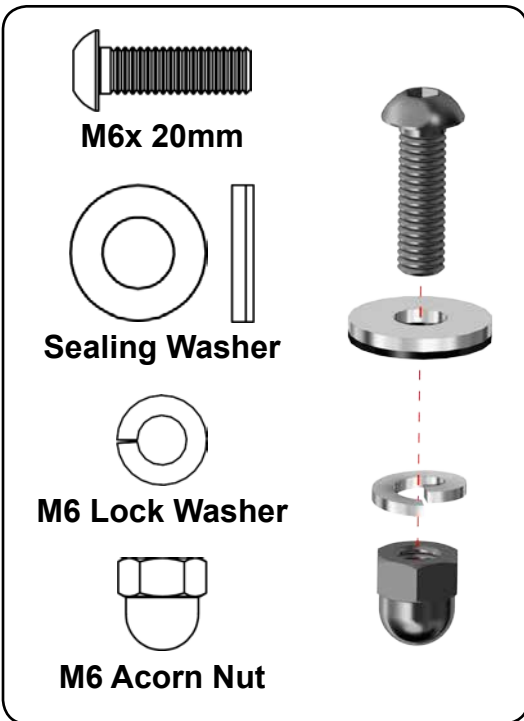

- Install Rear (D) to Middle Plate (C) with hardware shown.

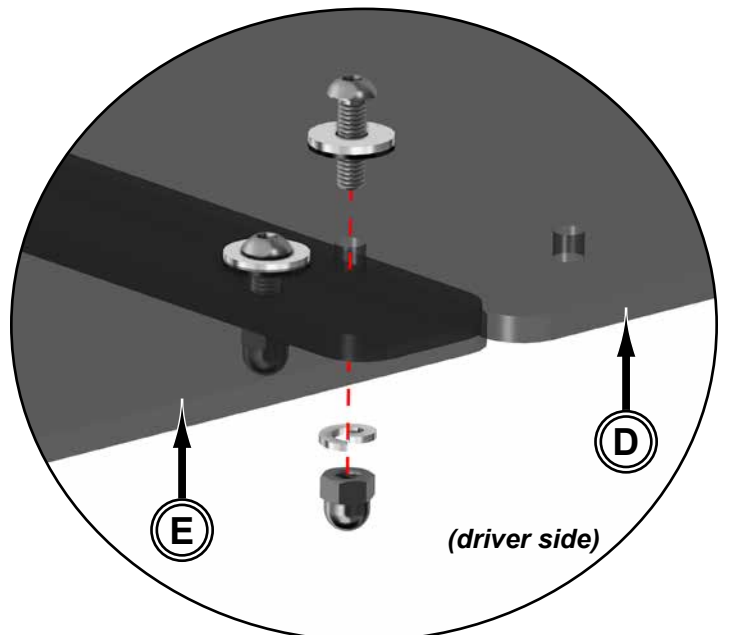

**Tighten hardware completely**



- Install one continuous piece of Seal down sides of Front (E) and Rear (D) as shown.

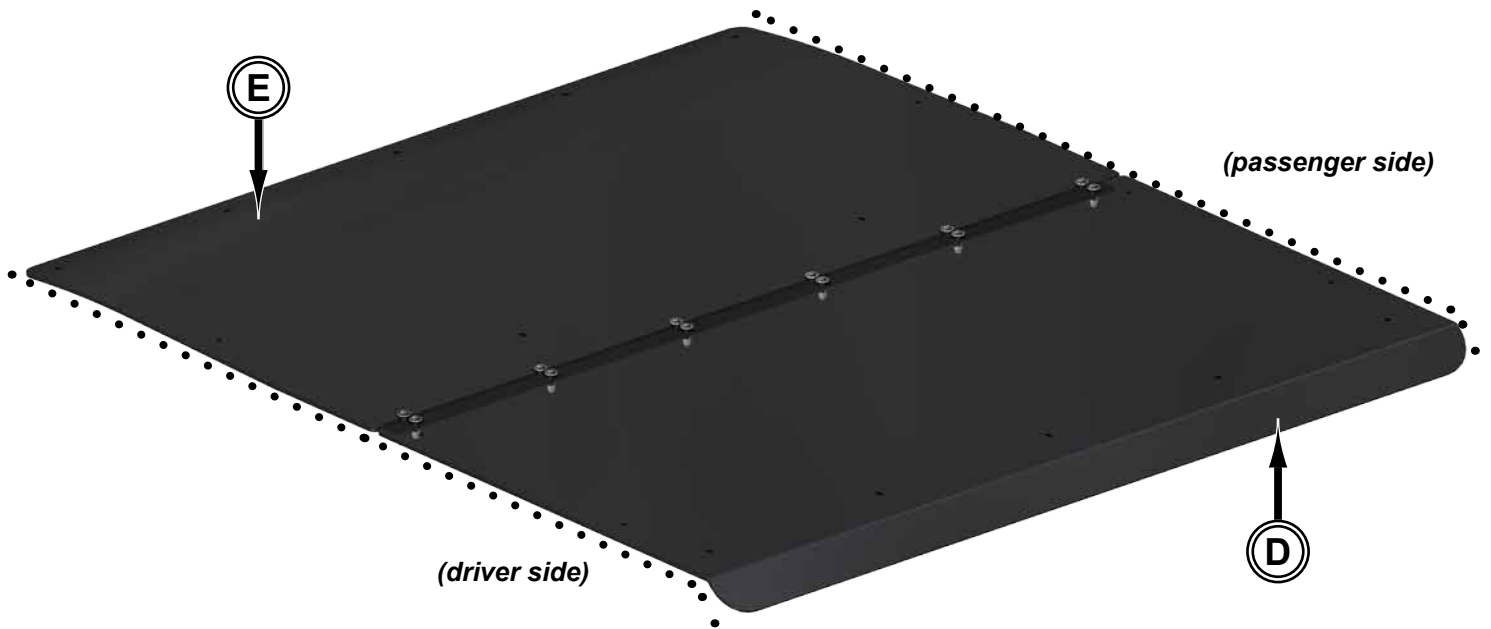

***Soak Seal in hot water before cutting or installing to increase flexibility.***

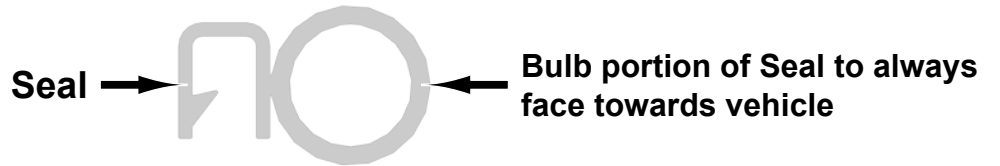

- Place Roof onto machine.

- Secure Roof and Front Plate (A) to machine.

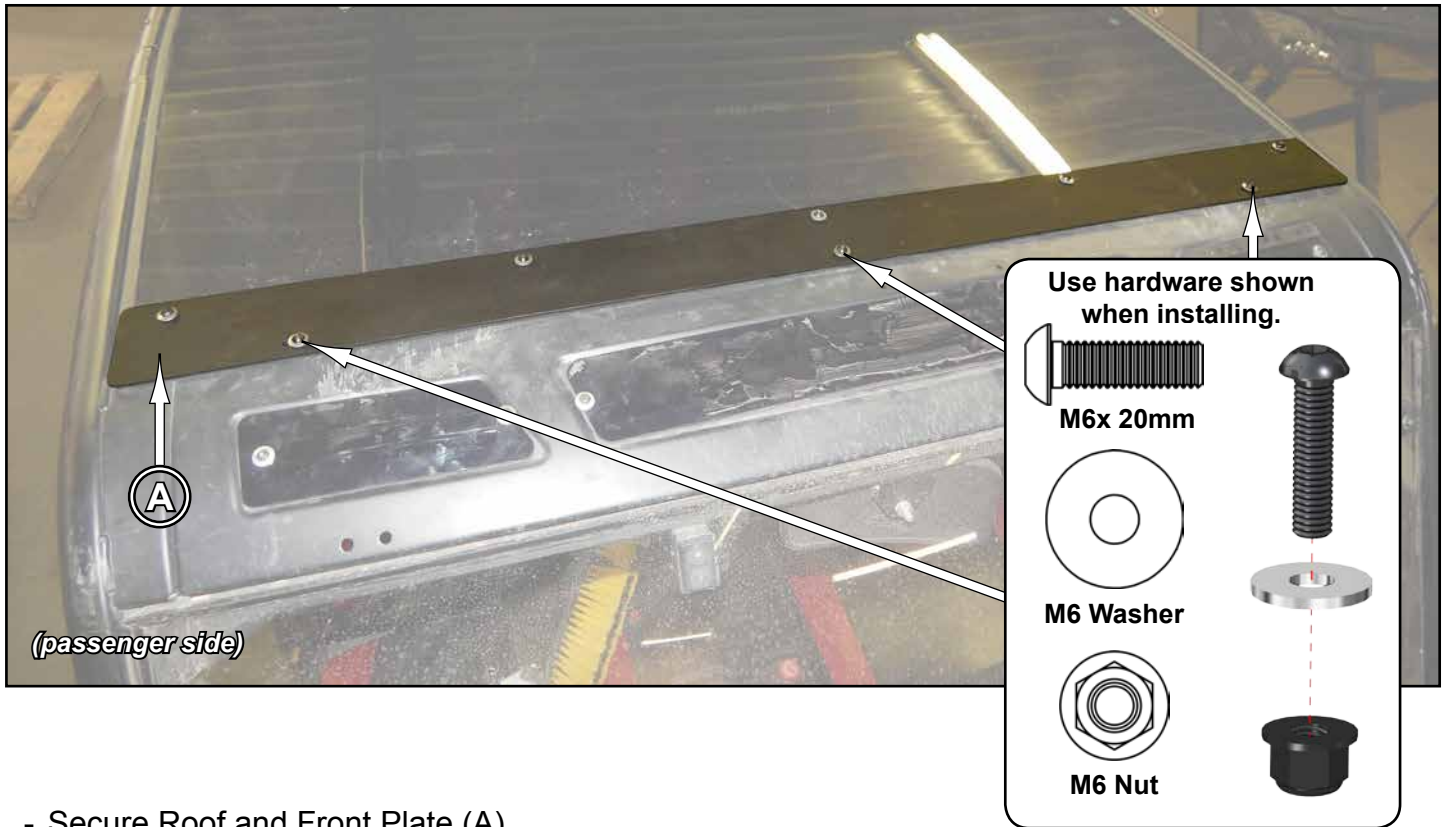

- Secure Roof and Front Plate (A).

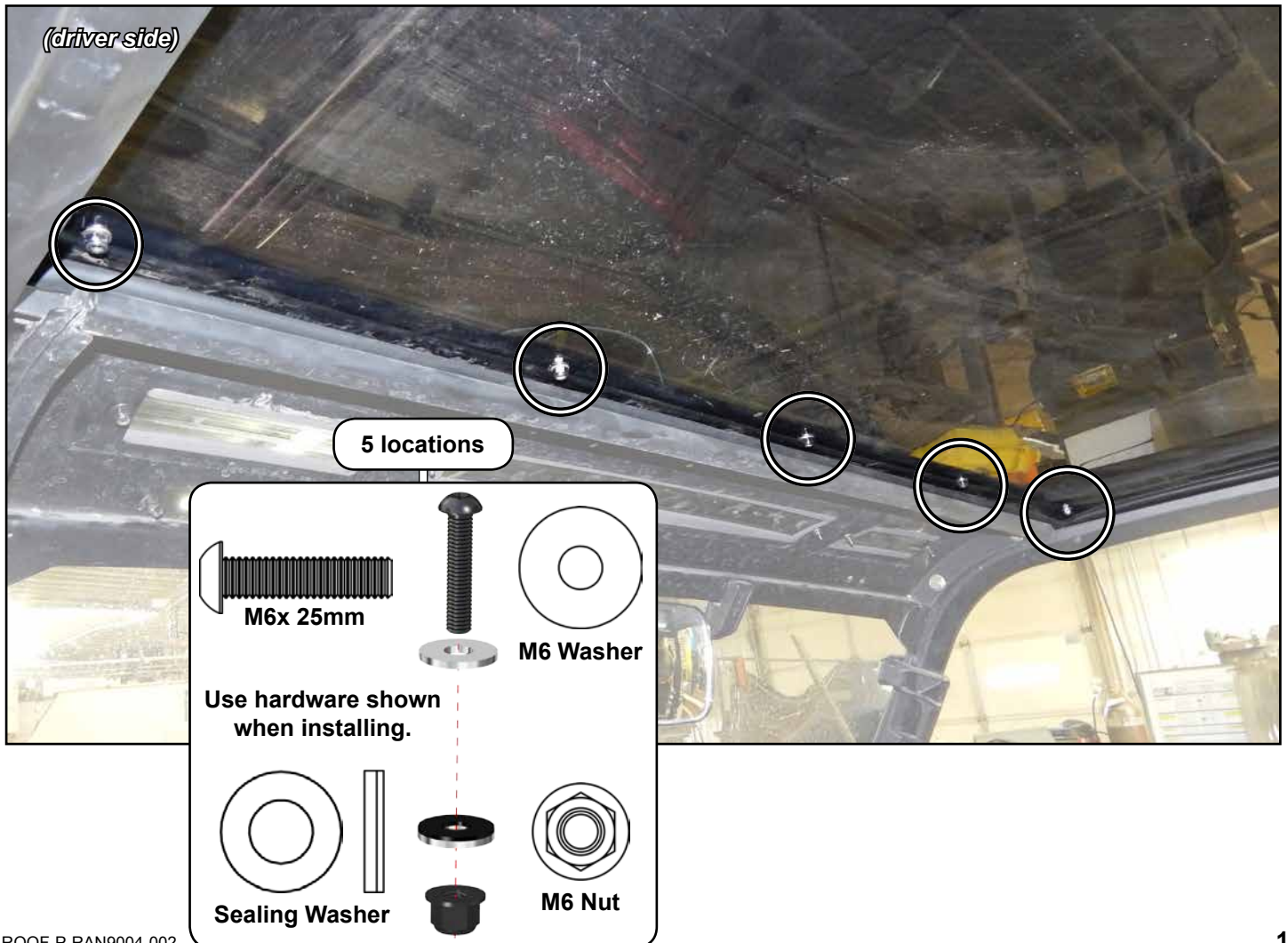

- Secure Roof to Middle Mount Brackets (L) and Rear Plate (B).

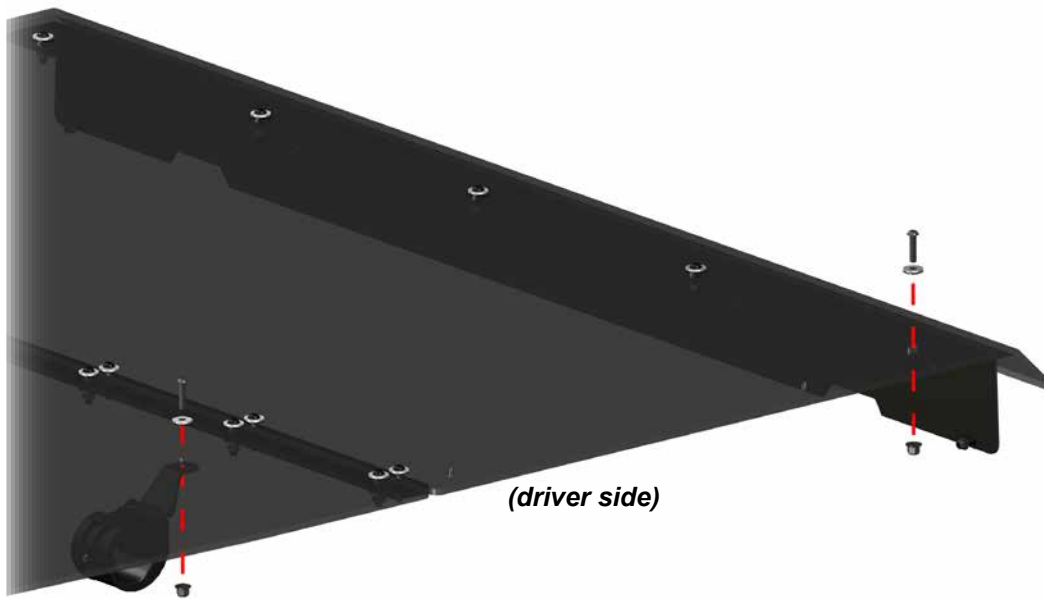

Use hardware shown when installing.

M6x 25mm

Sealing Washer

M6 Nut

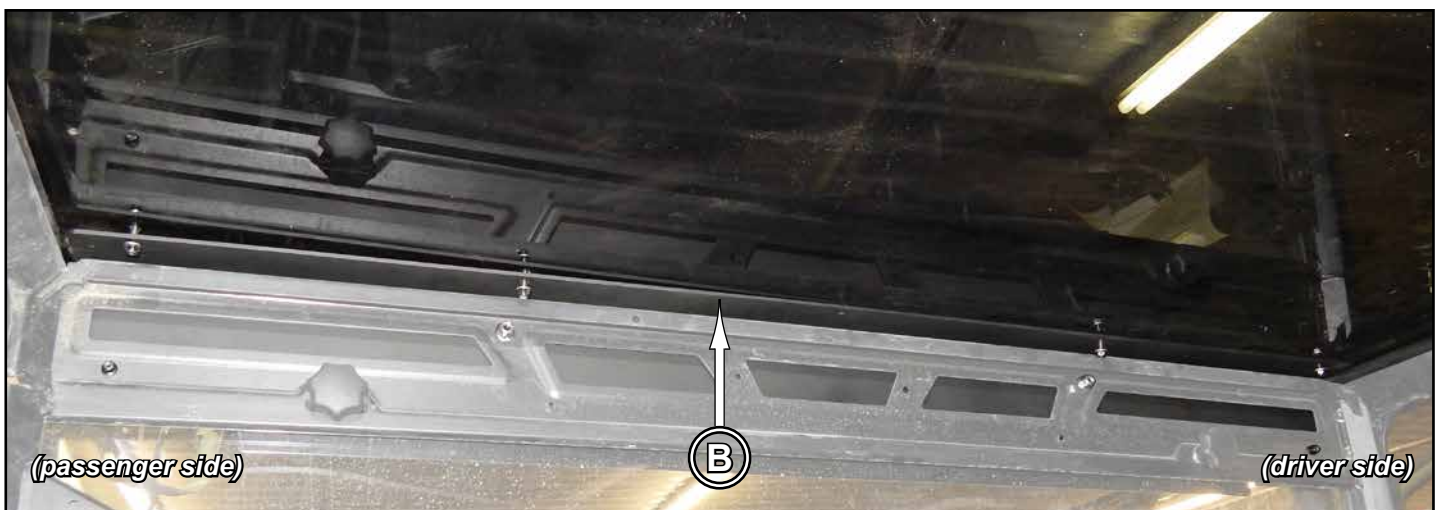

- Install Brackets (K) to Roof with hardware shown.

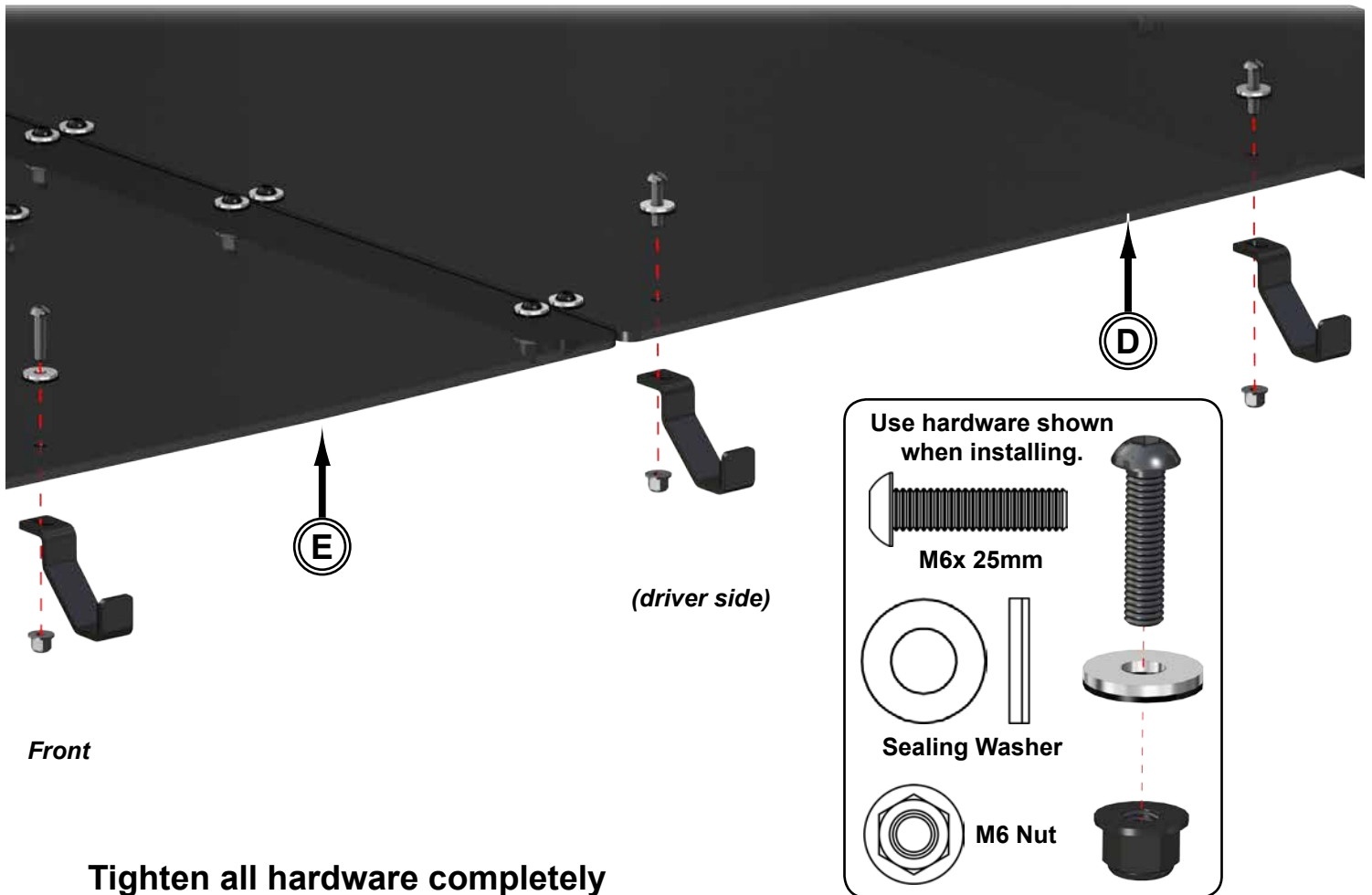
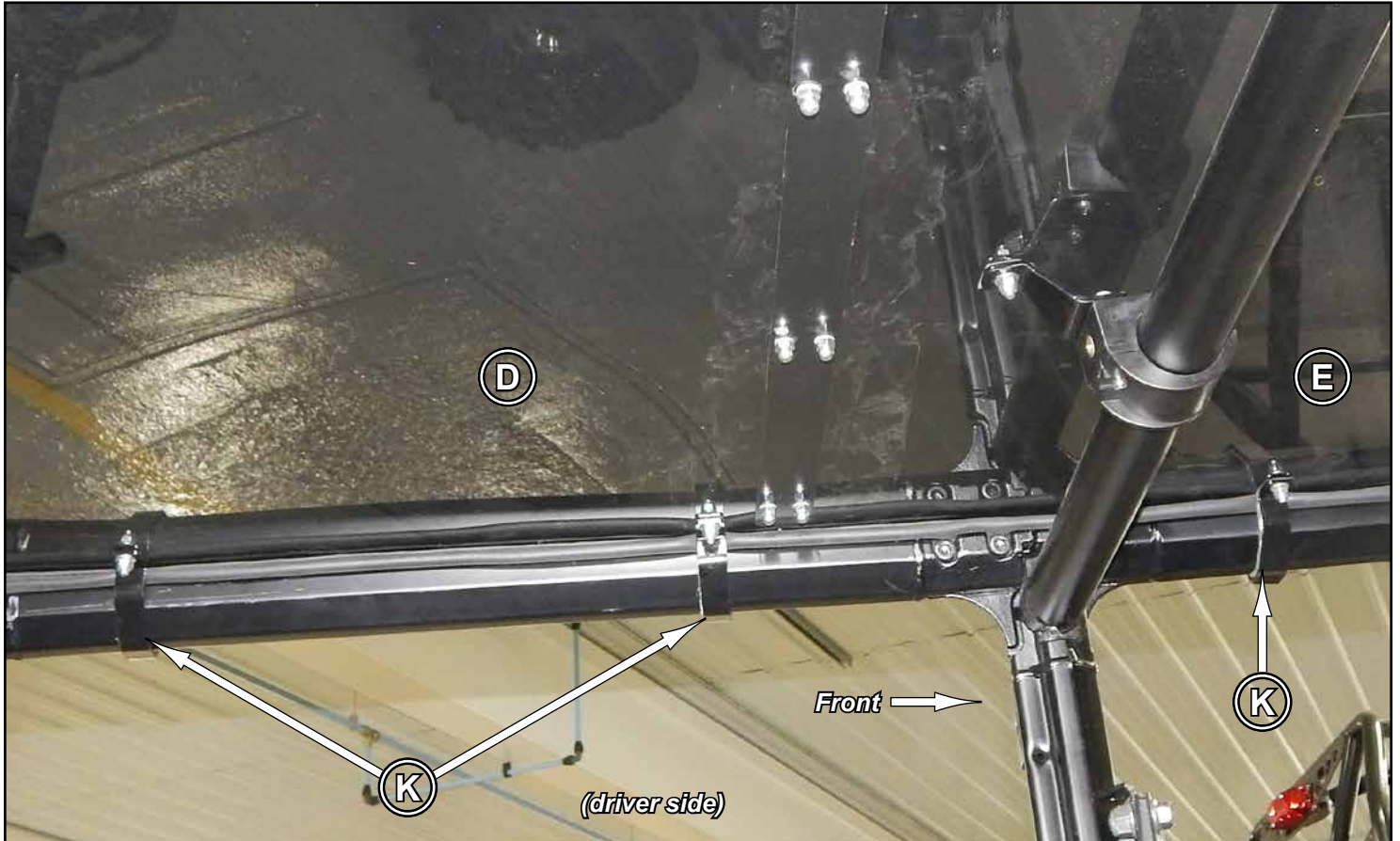

**Tighten all hardware completely**

**Liability Statement**

SuperATV's® products are designed to best fit user's ATV/UTV under stock conditions. Adding, modifying, or fabricating any factory or aftermarket parts will void any warranty provided by SuperATV® and is not recommended. SuperATV's® products could interfere with other aftermarket accessories. If user has aftermarket products on machine, contact SuperATV® to verify that they will work together.

Although SuperATV® has thousands of satisfied customers, user should be aware that installing lift kits, long travel, or suspension kits, tires, etc. will change the ride of machine and may increase maintenance and part wear. Operating any off-road machine while, or after, consuming alcohol and/or drugs increases risk of bodily harm or death. No warranty or representation is made as to this product's ability to protect user from severe injury or death. SuperATV® urges operators and occupants to wear a helmet and appropriate riding gear at all times.

By purchasing and installing SuperATV® products, user agrees that should damages occur, SuperATV® will not be held responsible for loss of time, use, labor fees, replacement parts, or freight charges. SuperATV®, nor any 3rd party, will not be held responsible for any direct, indirect, incidental, special, or consequential damages that result from any product purchased from SuperATV®. The total liability of seller to user for all damages, losses, and causes of action, if any, shall not exceed the total purchase price paid for the product that gave rise to the claim.

SuperATV® will warranty only parts provided by SuperATV®. Any damage or problems with OEM housings, bearings, seals, or other manufacturers' products will not be covered by SuperATV®. SuperATV® parts and products are not warrantied if item was not installed properly, misused, or modified.

Installing, adding, modifying, or fabricating any factory or aftermarket product to your ATV/UTV may violate certain local, state, and federal laws. Be advised that laws vary depending on town, city, county, state, etc. Use of certain products on public streets, roads, or highways may be in violation law. The Buyer is solely and exclusively legally and personally responsible for any violation of the law by the installation or use of the product. You must abide by all local, state, and federal laws, including but not limited to vehicle safety, traffic laws, and ordinances. It is your responsibility to know the laws and how they apply to you.

The Buyer is responsible to fully understand the capability and limitations of his/her vehicle according to manufacturer specifications, warnings and instructions and agrees to hold SuperATV® harmless from any damage resulting from failure to adhere to such specifications, warnings and/ or instructions. The Buyer is also responsible to obey all applicable federal, state, and local laws and ordinances when operating his/her vehicle while using this product, and the Buyer agrees to hold SuperATV® harmless from any violation thereof.