



1999-2002 Ford 7.3L Powerstroke **BD Turbo Mount Air Exhaust Brake**

Part# 2023144

Serial # _____

Date Purchased _____

Purchased from _____

Installed by _____

OWNER'S MANUAL – LEAVE IN GLOVE BOX

Installation Manual Part # I2023144

TABLE OF CONTENTS

Brake Kit Contents	3
Welcome.....	3
Options	3
Installation	4
Battery & Intercooler Pipe Removal	4
Stock Vacuum Pump & Reservoir Removal.....	5
Valve Installation	6
Air Compressor Reservoir Installation.....	8
Pump Relay Harness and Wiring	8
Engine Compartment Wiring & Hose Connections	9
Cab Wiring and Wiring Diagram.....	10
Optional Shifter Switch (Push-Pull Style)	11
Optional Shifter Switch (Rocker Switch Style).....	12
Cruise Control Disconnect Wiring (if equipped)	13
Control Wiring	14
Battery Reinstall	14
DFIV Calibration.....	14
Adjustment & Testing	15
Measuring Idle Brake Pressure	15
Ford Exhaust Brake RetroFit Kit (California Trucks)	16
Maintenance & Trouble Shooting	17
Operating Guidelines	17

Brake Kit Contents

2023144 – Ford 7.3L Powerstroke Exhaust Brake

Part #	Qty.	Description
2123144	1	Valve Assembly
1321039	1	DFIV Control Kit
1330440B	1	Vacuum Pump / Relay harness
1030124	1	Vacuum Pump relocation kit
1030125B	1	Air Pump Kit (w/ bracket)
1220145B	1	Air control kit
1057020	1	Retrofit Kit (California Trucks only)

Welcome

Thank you for purchasing a BD Engine Exhaust Brake. Your kit should have the above-mentioned items for your installation; please check to make sure that you have everything. This manual is to aid you with your installation and operation of your braking unit. We strongly suggest that you fill out the information below and retain this manual for any future reference.

Options

Description	Part #
Manual Transmission Shifter Switch Kit	1300210 / 1030900
BD X-Monitor Digital Gauge Kit	1087200
Performance Torque Converter	1030223
TowLoc Converter Control	1067700
BD Evolution Performance Tuner	1057100

BD Engine Brake Inc.

Plant Address: 33541 MacLure Rd. Abbotsford, BC, Canada V2S 7W2

U.S. Shipping Address: 88-446 Harrison St, Sumas, WA 98295 U.S. Mailing Address: P.O. Box 231, Sumas, WA 98295

Phone: 604-853-6096 | Fax: 604-853-8749 | Internet: www.bd-power.com

Installation

Battery & Intercooler Pipe Removal

Disconnect the negative terminals on both of the vehicle's batteries, and then disconnect the positive terminals. Remove the passenger side battery.

To gain access to the EBP Valve and wiring, remove the intercooler pipe on the passenger side by loosening off the clamp on the rubber bellows that is attached to the intercooler rad and the clamp on the rubber bellows that attaches the intercooler pipe to the intake manifold.

Remove the sensor hose and wire connector from the MAP sensor.

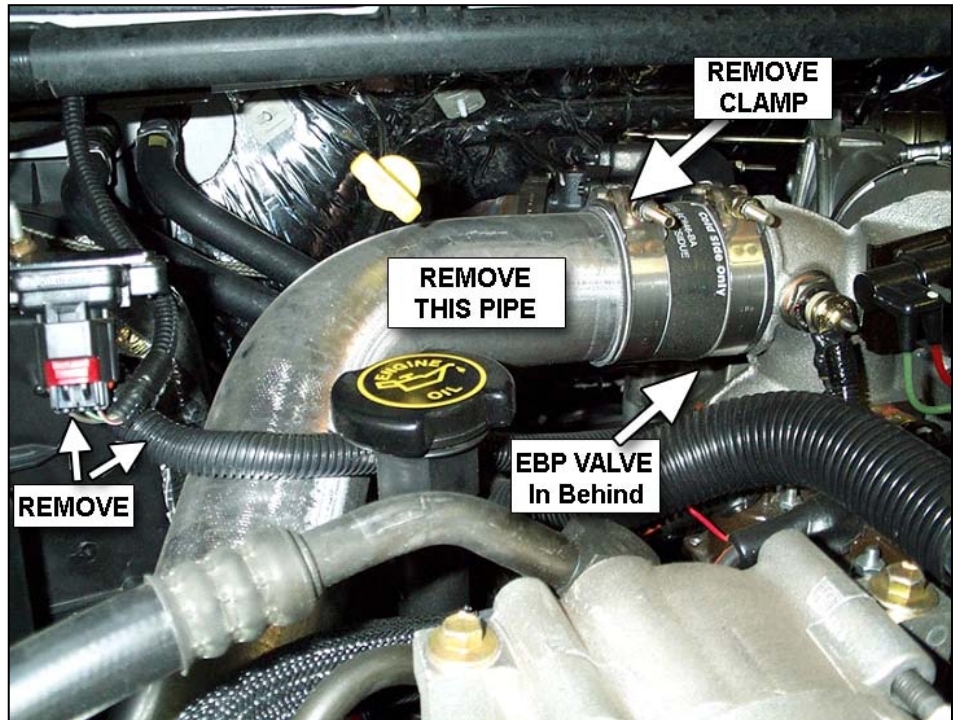

When removing the pipe, the lower rubber bellows that connects to the intercooler rad should remain on the pipe. The pipe slides out of the rubber bellows that is still attached to the intake manifold.

Remove the turbo outlet housing. Inspect the turbo exhaust clamp, turbo down pipe and turbo outlet for any carbon build-up or damage that may cause problems sealing on exhaust mating surfaces.

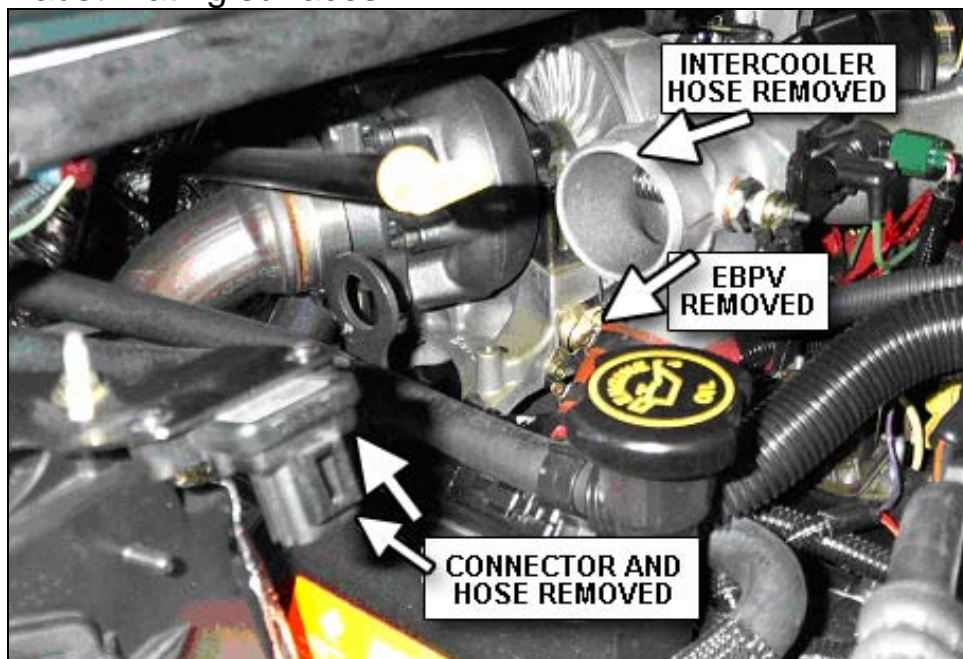

BD Engine Brake Inc.

Plant Address: 33541 MacLure Rd. Abbotsford, BC, Canada V2S 7W2

U.S. Shipping Address: 88-446 Harrison St, Sumas, WA 98295 U.S. Mailing Address: P.O. Box 231, Sumas, WA 98295

Phone: 604-853-6096 | Fax: 604-853-8749 | Internet: www.bd-power.com

Stock Vacuum Pump & Reservoir Removal

Locate the small electric vacuum pump and reservoir on the passenger side fender well. Remove the reservoir by removing the bolts on the under side of fender well, and disconnect the hoses. Remove the small electric vacuum pump by removing the screws, unplugging the electrical plug and pulling off the supply tube to the reservoir.

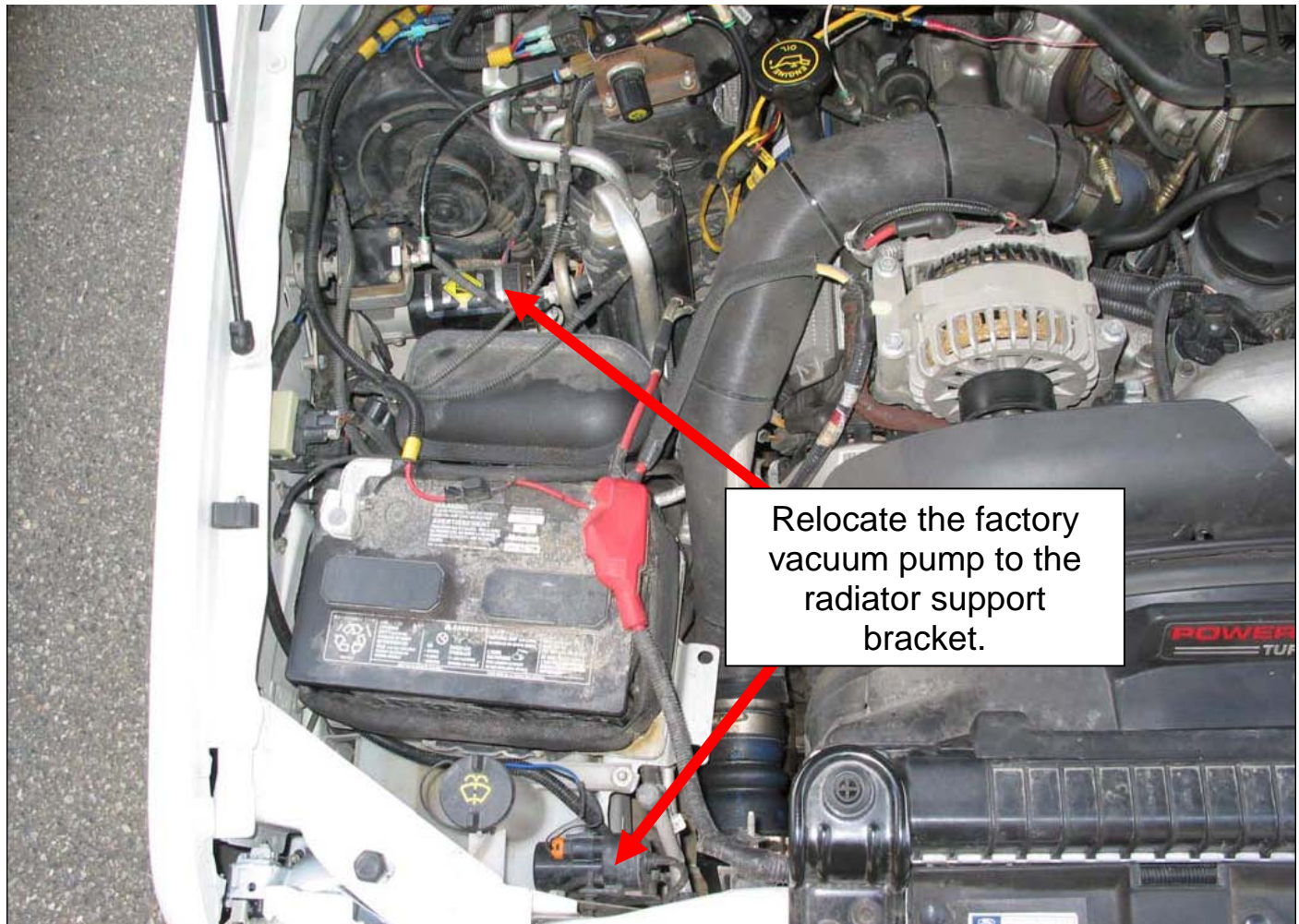

Remove the electric vacuum pump from the stock mounting location and re-install it on the new mount provided. Trim the rubber ends on the three vibration dampers to clear when reinstalling. Install on the right hand side of radiator support bracket with the two bolts and washers provided.

Cut the power supply wires for the stock electric vacuum pump approximately 4" from the connector and splice in the black and blue wires supplied using the butt connectors and shrink tubing. The 1/8" plastic tube will run inside the same loom against the fender.

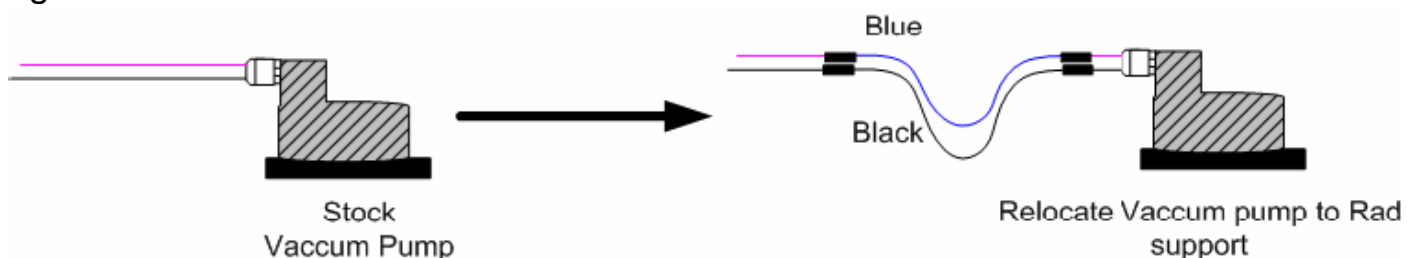

BD Engine Brake Inc.

Plant Address: 33541 MacLure Rd. Abbotsford, BC, Canada V2S 7W2

U.S. Shipping Address: 88-446 Harrison St, Sumas, WA 98295 U.S. Mailing Address: P.O. Box 231, Sumas, WA 98295

Phone: 604-853-6096 | Fax: 604-853-8749 | Internet: www.bd-power.com

Valve Installation

Remove the engine-lifting eye by the turbo outlet. Remove and retain the turbo exhaust clamp between the turbo and exhaust pipe. Loosen off the two (2) bolts that secure the turbo down pipe to the catalytic convertor under the truck.

Remove and retain the seven (7) mounting bolts of the outlet housing on the turbo using a **5/16" 12pt socket**. Loosen the outlet housing and turn it downward to expose the valve actuation rod.

Disconnect the actuation rod from the bottom of the outlet housing.

NOTE: The clip that holds the rod to the outlet housing is similar to that found on carburetors.

To prevent the rod from hanging, which can cause the rod seal to leak due to vibration, install the supplied rod support fitting. This is a brass fitting that has a cut in it, which fits around the rod and holds the rod securely.

The EBP Valve will not be required with the installation of the BD Exhaust Brake. It is recommended that the EBP Valve wiring harness be disconnected to prevent the actuator rod from moving to protect the seal.

NOTE: ON CALIFORNIA MODEL VEHICLES THE EBP VALVE WIRING MUST BE CONNECTED TO ENSURE THE ECM DOES NOT SET AN ENGINE TROUBLE CODE.

Install the BD Brake Valve Assembly on the turbo, using the original mounting bolts. Secure the exhaust pipe to the BD Brake Valve, using the original turbo exhaust clamp then reinstall the intercooler pipe and tighten bolts on catalytic convertor.

Reconnect the sensor hose and wire connector from the MAP sensor.

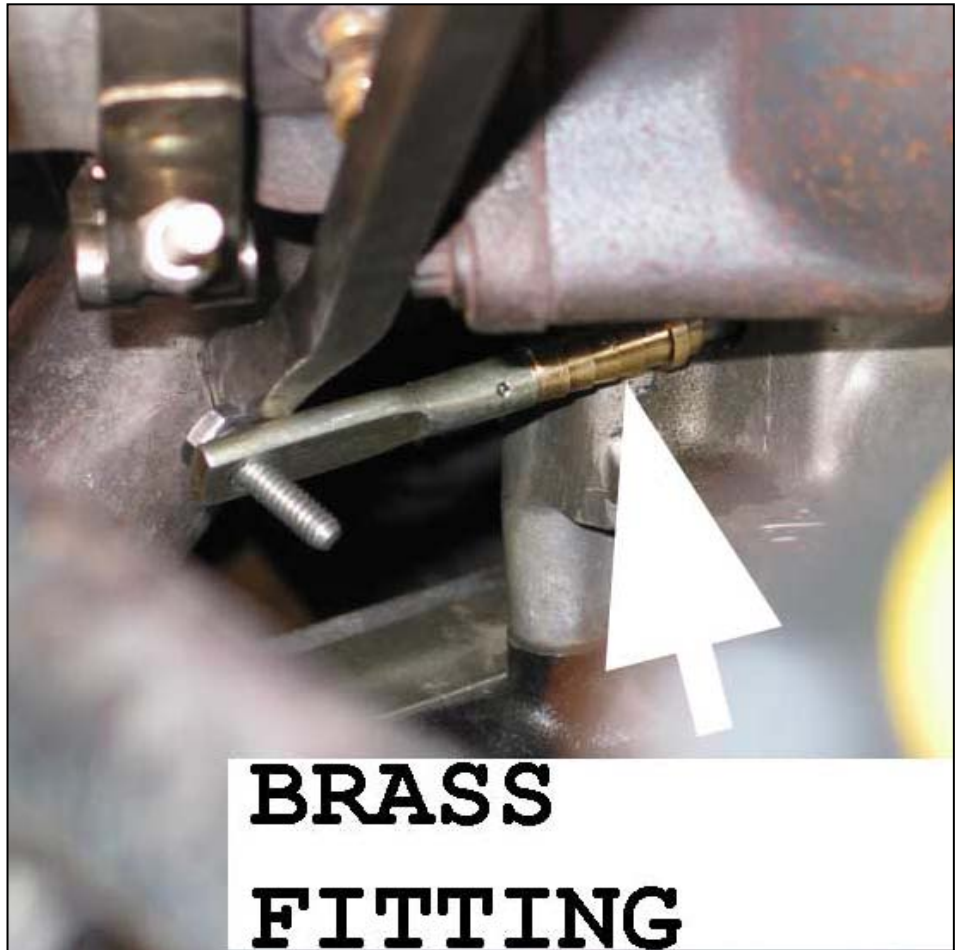

BD Engine Brake Inc.

Plant Address: 33541 MacLure Rd. Abbotsford, BC, Canada V2S 7W2

U.S. Shipping Address: 88-446 Harrison St, Sumas, WA 98295 U.S. Mailing Address: P.O. Box 231, Sumas, WA 98295

Phone: 604-853-6096 | Fax: 604-853-8749 | Internet: www.bd-power.com

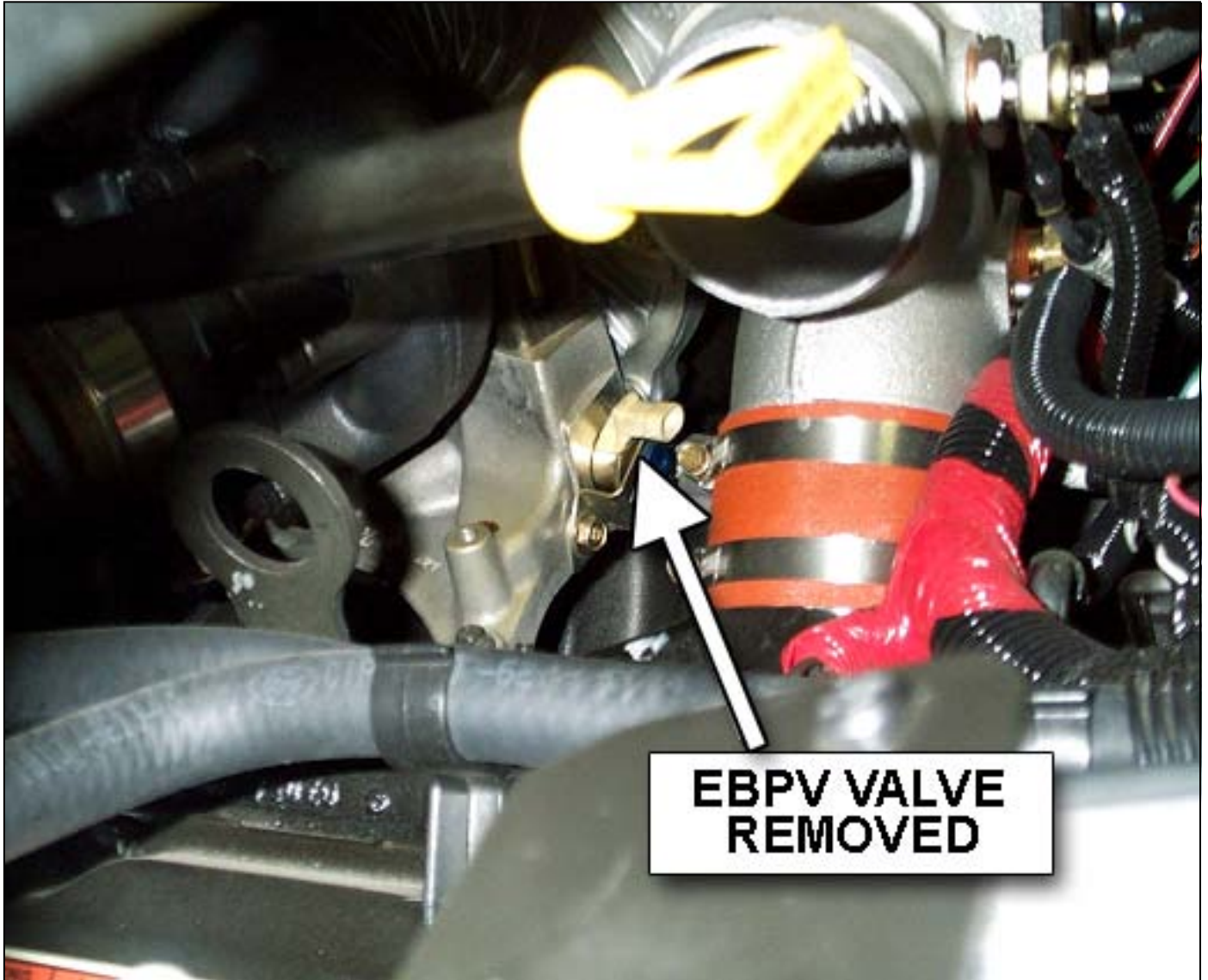

Air Compressor Reservoir Installation

Install the mounting bracket of the BD High Capacity Air Compressor in the same location that the small electric vacuum pump was removed from. Secure it to the side of the engine compartment with the supplied fender screws.

Install the BD Air Compressor onto the bracket with washers & lock nuts supplied, and re-install the reservoir back into its original location. Re-attach all hoses that were previously disconnected.

Pump Relay Harness and Wiring

Consult the "Engine Compartment Wiring and Hose Connections" diagram for proper connections.

Install the Control Valve & Regulator on top of the AC unit where the boost pressure is measured. Install the relay mount on one of the existing screws and route the harness over to fender and secure. Make wire connections as per wiring diagram.

With the last two connectors at the end of the harness, attach the Black wire to the negative terminal on the passenger side battery and the fused red wire to the positive terminal. Battery terminal nuts are provided in the kit.

BD Engine Brake Inc.

Plant Address: 33541 MacLure Rd. Abbotsford, BC, Canada V2S 7W2

U.S. Shipping Address: 88-446 Harrison St, Sumas, WA 98295 U.S. Mailing Address: P.O. Box 231, Sumas, WA 98295

Phone: 604-853-6096 | Fax: 604-853-8749 | Internet: www.bd-power.com

Engine Compartment Wiring & Hose Connections

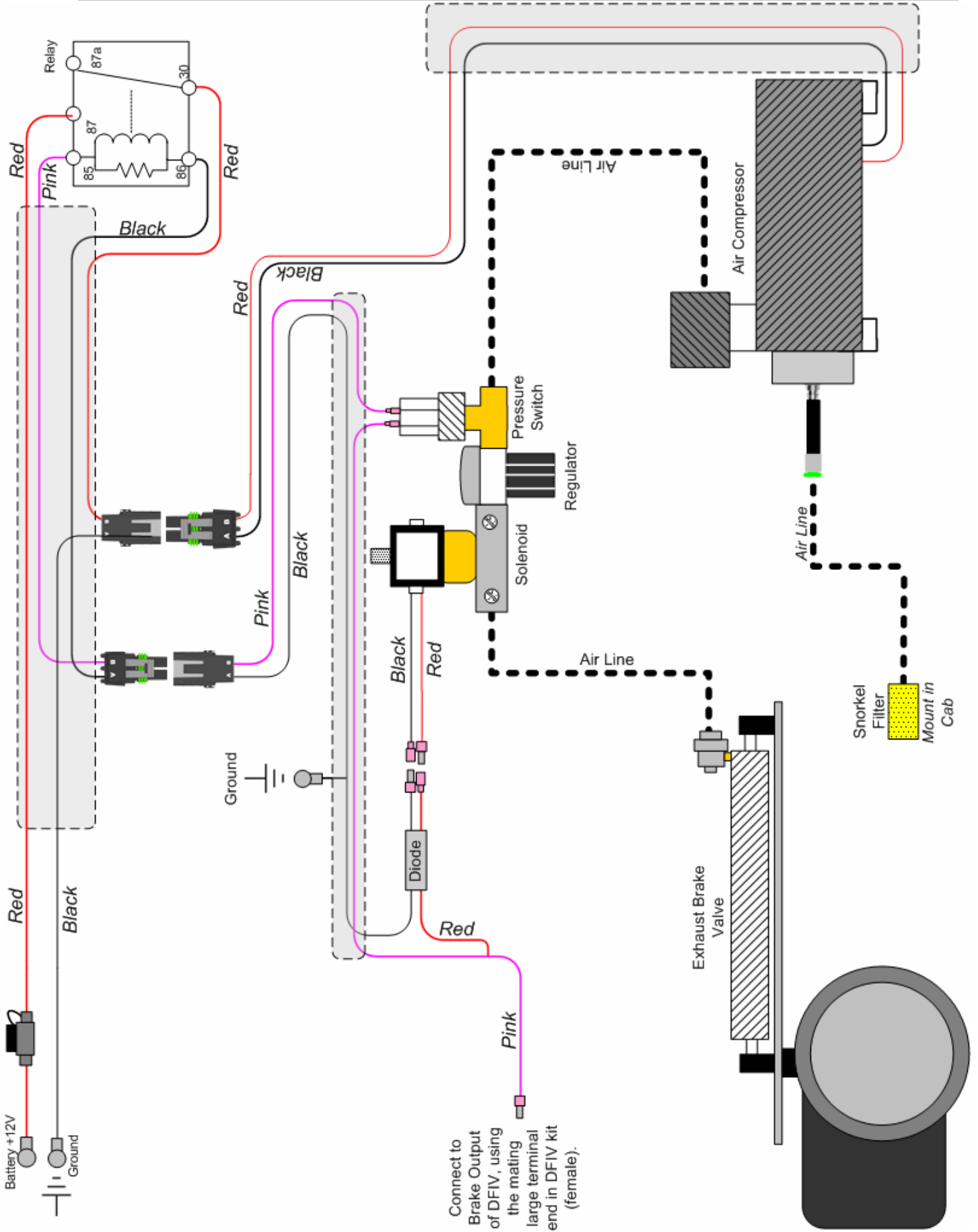

BD Engine Brake Inc.

Plant Address: 33541 MacLure Rd. Abbotsford, BC, Canada V2S 7W2

U.S. Shipping Address: 88-446 Harrison St, Sumas, WA 98295 U.S. Mailing Address: P.O. Box 231, Sumas, WA 98295

Phone: 604-853-6096 | Fax: 604-853-8749 | Internet: www.bd-power.com

Cab Wiring and Wiring Diagram

NOTE: IF A BD TOWLOC IS TO BE INSTALLED WITH THIS BRAKE YOU MUST SKIP THE WIRING SECTION IN THIS MANUAL AND FOLLOW THE TOWLOC INSTRUCTIONS FOR CORRECT WIRING INSTALLATION. AFTER INSTALLING THE TOWLOC REFER TO THE ADJUSTMENT & TESTING SECTION ON PAGE 15.

CAUTION: Before installing any wiring modifications or equipment ensure to disconnect the battery Ground (Negative) terminals on all the vehicle batteries as damage to the vehicle's ECU and/or installed components may result.

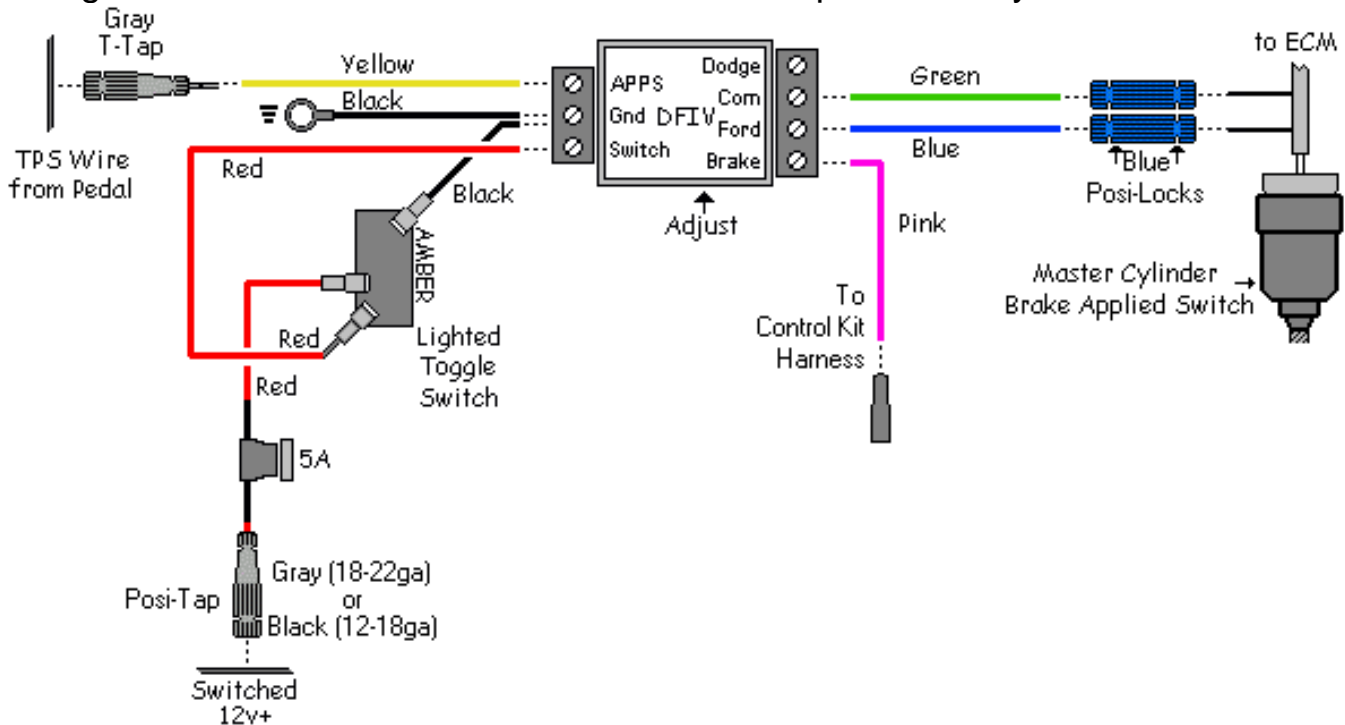

Remove lower section of dash, under the steering column, and mount the DFIV module to the cross member under the steering column. Connect the Black wire from the DFIV module to a good ground.

Locate the one of the ignition switched Red /Black tracer wires under the steering column (one is 10/12ga and the other is 14/16ga) and connect an appropriate Posi-Tap connector to it (yellow for 10/12ga, black for 14/16ga, and red for 18/20ga wire). Connect the fused red wire from the Toggle Switch to this Posi-Tap and then mount the Toggle Switch in a convenient spot on the dash.

Locate the Throttle Position Sensor at the throttle pedal and, using a red Posi-Tap connector, attach the Yellow wire from the DFIV module to the Grey wire w/White tracer on the TPS.

Ensure the Green wire is connected to the 'COM' terminal of the DFIV module, the Blue wire is connected to the 'FORD' terminal of the DFIV module, and the Pink wire is connected to the 'BRAKE' terminal of the DFIV module. Also check to ensure all other wires at the DFIV module are secure.

BD Engine Brake Inc.

Plant Address: 33541 MacLure Rd. Abbotsford, BC, Canada V2S 7W2

U.S. Shipping Address: 88-446 Harrison St, Sumas, WA 98295 U.S. Mailing Address: P.O. Box 231, Sumas, WA 98295

Phone: 604-853-6096 | Fax: 604-853-8749 | Internet: www.bd-power.com

NOTE: If the vehicle does not have Cruise Control, remove the Green and Blue wire from the install and discard.

Run the other end of these wires through a grommet on the firewall, making sure all wires are secure and are far enough away from moving objects or heat sources.

Optional Shifter Switch (Push-Pull Style)

To install the optional Manual Shifter Switch Kit, mount the switch onto the shift lever using the clamp supplied. Run the cable down the shifter shaft, securing the cable with zip-ties or electrical tape, and run under the carpet to the firewall and under the dash to the relays, leaving enough slack for proper shifting of the transmission lever and to prevent any rubbing of wire.

At the end of the cable, cut off any excess and strip away about 1 to 2 inches of the black rubber covering, exposing the black and white (or Green) wires then strip the insulation from the ends of the two wires.

Connect the White (or Green) wire to the "Switch" terminal on the DFIV Module.



Attach a male blade connector to the Black wire. Remove the fused Red wire from the toggle switch (the toggle switch and remaining Red and Black wire attached to the switch will no longer be needed) and attach to the Black wire from the optional switch to the female connector of the fused Red wire.

Locate one of the ignition switched red/black tracer wires under the steering column (one is 10/12ga and the other is 14/16ga) and connect an appropriate Posi-Tap connector to it (yellow for 10/12ga, black for 14/16ga, and red for 18/20ga wire) then connect the fused Red wire to this Posi-Tap.

BD Engine Brake Inc.

Plant Address: 33541 MacLure Rd. Abbotsford, BC, Canada V2S 7W2

U.S. Shipping Address: 88-446 Harrison St, Sumas, WA 98295 U.S. Mailing Address: P.O. Box 231, Sumas, WA 98295

Phone: 604-853-6096 | Fax: 604-853-8749 | Internet: www.bd-power.com

Optional Shifter Switch (Rocker Switch Style)

Mount the shifter switch onto the shift lever using the clamp supplied (either 5/8" or 3/4"). Run the electrical cable down the shifter shaft, securing the cable with zip-ties or electrical tape, and run it under the carpet to the firewall and under the dash to the relays, leaving enough slack for proper shifting of the transmission lever and to prevent any rubbing of wire.

At the end of the cable, cut off any excess and strip away about 1-2" of the black rubber insulation exposing the black, white and green wires, then strip the insulation from the ends of the three wires.

Connect the green 12V output green wire to the "Toggle Switch" input terminal on the DFIV.

Attach the 5/16" ring connector to the black ground wire and attach it to a good ground nearby.

Locate one of the ignition switched power fuses in the fuse panel underneath the steering column. Use the supplied fuse tap to supply ignition switched power to the "Keyed 12 Volts" (white) wire of the rocker switch assembly.

Also provided in the kit is a Posi-Tap connector as an alternative to the fuse tap and flag connector. If you want to use the Posi-Tap instead of using the fuse tap in the fuse panel, then you will need to locate a 12V switched ignition wire to power the switch. You could also use the 12V Switched Power source that powers the DFIV.

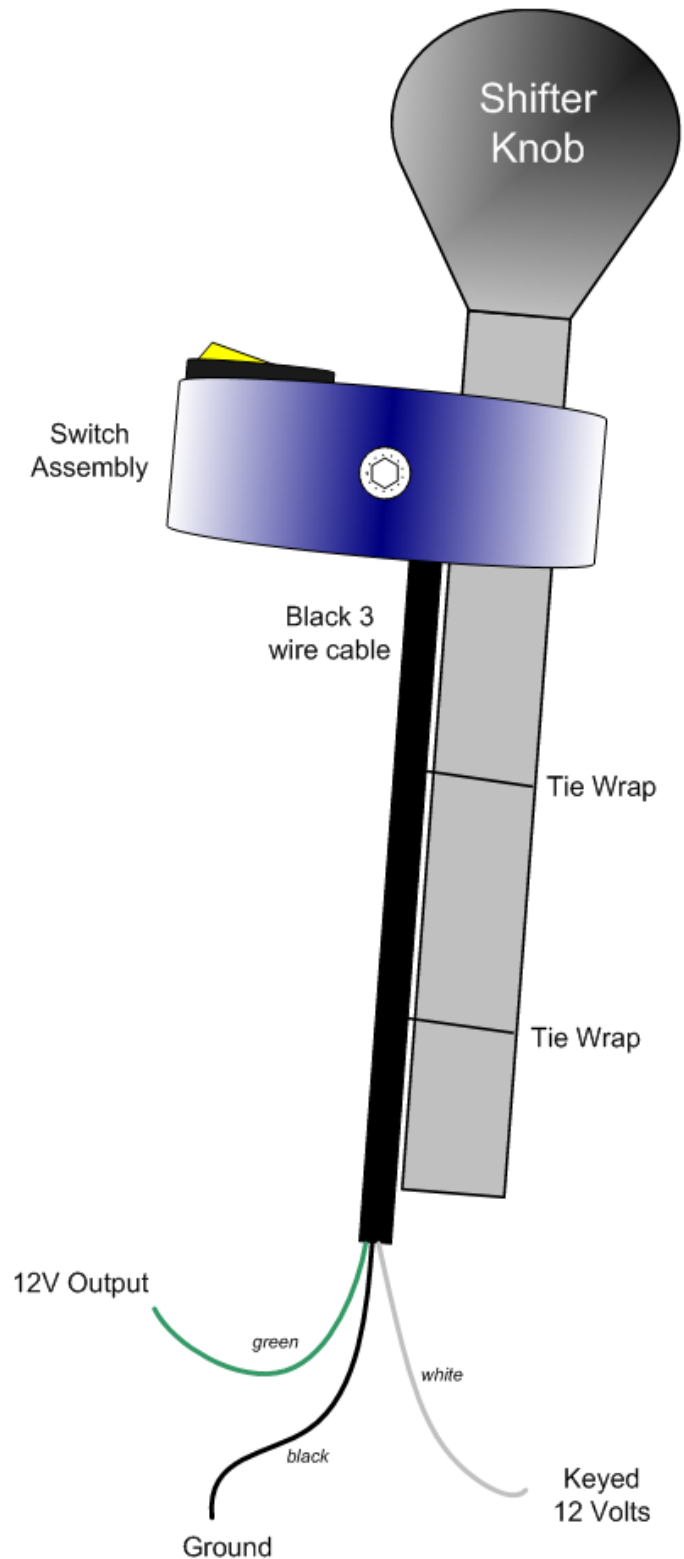

Cruise Control Disconnect Wiring (if equipped)

NOTE: If the vehicle does not have Cruise Control, remove the Green and Blue wire from the install and discard. Jump to the Control Wiring section.

Consult the wiring diagram for proper connections and locate the Brake Applied Switch on top the hydraulic brake booster.

Locate the Black w/Yellow wire at the Cruise Control Disable (Brake Applied) switch located on the brake master cylinder and expose the wiring approximately 4 to 6 inches from the switch to allow for a good length to work with.

NOTE: This wire may be a different color in various applications. If there is no Black w/Yellow wire going to this switch, use a test light to check which wire changes state (power to no power) when the brake pedal is applied.

Cut the black wire w/yellow tracer (BK/Y), and attach the blue Posi-Lock connectors to both sides of the cut wire.

Run the green and blue supplied wires that were brought through the firewall to the Brake Applied Switch at the brake booster and trim to fit. Now connect the blue and green wires to Posi-Lock connectors that were installed earlier to the Black w/yellow wires. It does not matter which wire which wire is connect where.

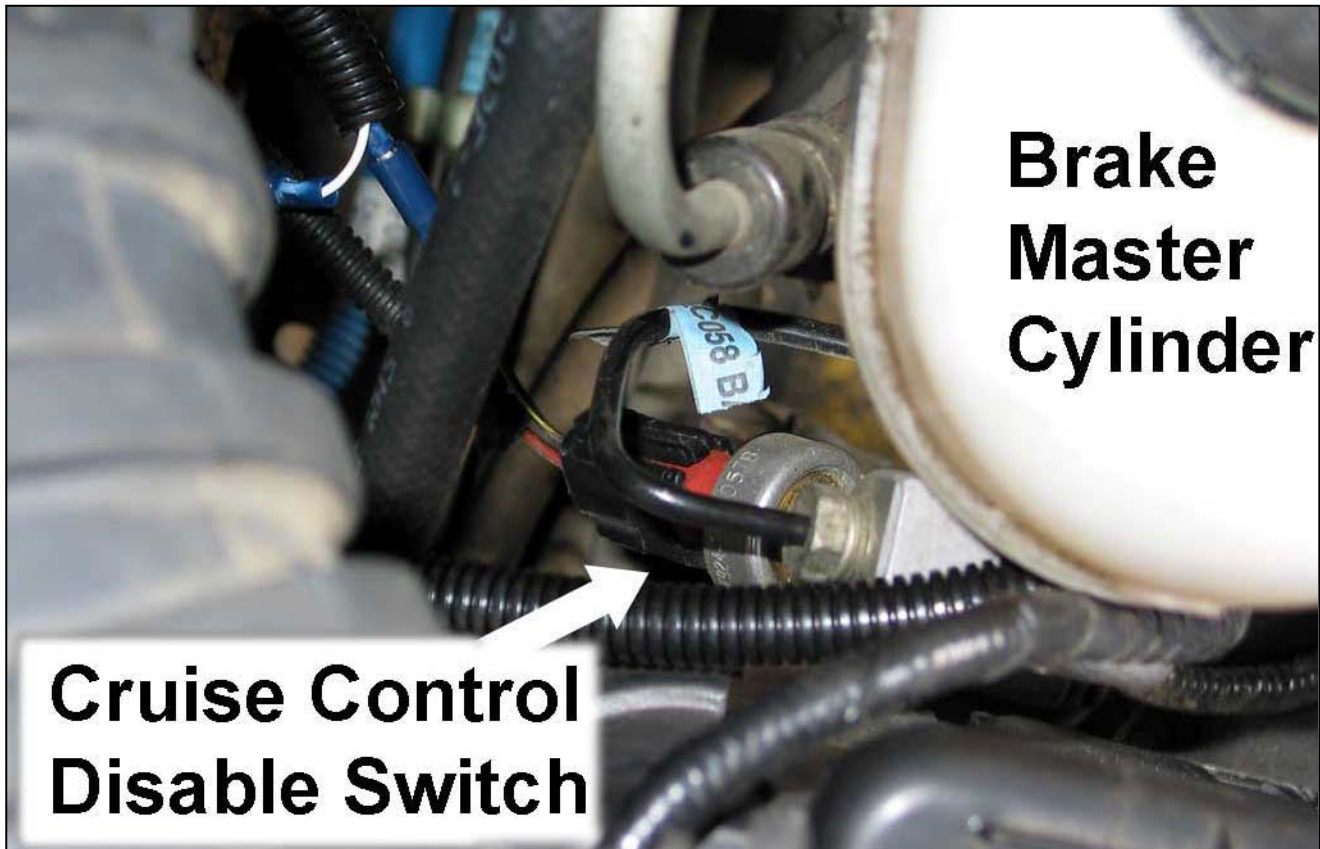

BD Engine Brake Inc.

Plant Address: 33541 MacLure Rd. Abbotsford, BC, Canada V2S 7W2

U.S. Shipping Address: 88-446 Harrison St, Sumas, WA 98295 U.S. Mailing Address: P.O. Box 231, Sumas, WA 98295

Phone: 604-853-6096 | Fax: 604-853-8749 | Internet: www.bd-power.com

Control Wiring

Run the pink wire that came through the firewall (from the DFIV module). Strip away some of the insulation and install a female bullet connector (with large terminal) then plug the connector onto the mating pink wire on the control kit harness. Secure all wires and hoses to ensure they are out of the way of moving and heated items.

Battery Reinstall

Reinstall the passenger side battery. Reconnect the positive terminals on both batteries then reconnect the negative terminals.

DFIV Calibration

Ensure the connections of the corresponding wires to the DFIV Control Module are correct as shown in the wiring diagram.

To achieve the correct setting for the activation of the exhaust brake in relation to the throttle pedal the DFIV Module must be calibrated for your vehicle.

Connect one end of a test light to the "BRAKE" terminal of the DFIV module and the other end to a good ground.



With the throttle at idle, start the engine and turn on brake switch. Then, using a small flat bladed screwdriver, turn the small adjusting screw in the DFIV Module counterclockwise or clockwise until the test light JUST turns on.

CAUTION: THE ADJUSTING SCREW IS A MICRO-SWITCH THAT IS VERY DELICATE, SO TURN USING SMALL ADJUSTMENTS.

Test by revving up the engine to approximately 1200 RPM and releasing the throttle. As the accelerator pedal is applied the test light should turn off just before the engine starts to rev, indicating proper calibration of the DFIV Module with the APPS.

Then the test light should activate again when the throttle pedal returned to idle. If not, readjust the DFIV Module so that it does. Reinstall lower dash cover.

BD Engine Brake Inc.

Plant Address: 33541 MacLure Rd. Abbotsford, BC, Canada V2S 7W2

U.S. Shipping Address: 88-446 Harrison St, Sumas, WA 98295 U.S. Mailing Address: P.O. Box 231, Sumas, WA 98295

Phone: 604-853-6096 | Fax: 604-853-8749 | Internet: www.bd-power.com

Adjustment & Testing

Start the engine and turn the Exhaust Brake on. Press on the Accelerator Pedal to rev-up the engine to approximately 1200 RPM and release. The brake should have disengaged then activated again when the engine returns to idle.

The idle pressure should be 10–15 lbs and CANNOT be raised using the stop bolt as adjustment. If an adjustment is thought to be necessary, contact BD Technical Support FIRST. **NOTE: The butterfly valve has been preset at the factory and should not be adjusted.**

The Regulated Pressure is adjusted with the regulator on the Control Assembly and has been preset to a MAX of 45 Lbs.

CAUTION: Do NOT exceed this pressure in the exhaust system.

While driving, turn Cruise Control on, then try to activate brake, the activation of the brake should disconnect cruise. Turn brake off and activate cruise again, this time pressing down on the hydraulic brake pedal to ensure cruise disconnects when the brake pedal is applied.

Measuring Idle Brake Pressure

As mentioned in these installation instructions, the backpressure must be measured and adjusted when the vehicle is at idle. For easier hook up of a gauge, the pressure can be measured by removing the backpressure switch behind the belt idler pulley on the front of the engine and plumb the gauge to the pressure tube.

It is required that a standard pressure gauge be used to make the necessary adjustments to the brake valve. Adjust the brake to reach approximately 10-15 lbs while the engine is at idle.

NOTE: Over the next two weeks, the backpressure at idle may rise due to initial carbon build up and the brake valve will need to be adjusted again.

Check for any exhaust leaks and recheck all connections and hoses for security and interference from moving or heated items. After about 100 miles (160 km), re-torque the turbo exhaust clamp and flange bolts.

Ford Exhaust Brake RetroFit Kit (California Trucks)

The purpose of this kit is to cure the problematic Ford P-Code in regards to exhaust back pressure being too high. This code is normally set with California Powerstrokes when using an exhaust brake. This kit should only be used on California trucks that exhibit the problem.

To install, locate the Exhaust Back Pressure sensor at the front of the engine, just behind the idler pulley and to the left of the water pump outlet hose.

Install the supplied Posi-Tap™ connector on to the Violet with Light Blue wire (2000 – 03) or the Pink with Light Blue wire (1999).

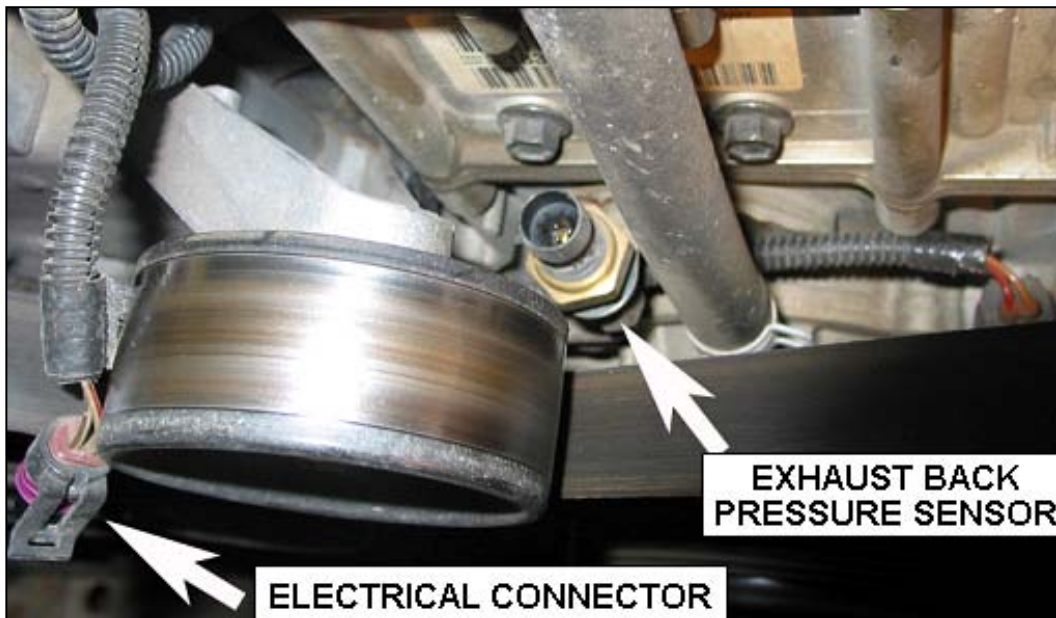

Connect the black wire pigtail to the Posi-Tap™ connector using the male blade connector.

Run the remaining wire away from the belt and the pulley and use the nearest engine bolt as a ground.

Do not cut or shorten the supplied wire. There is a diode located inside of it.

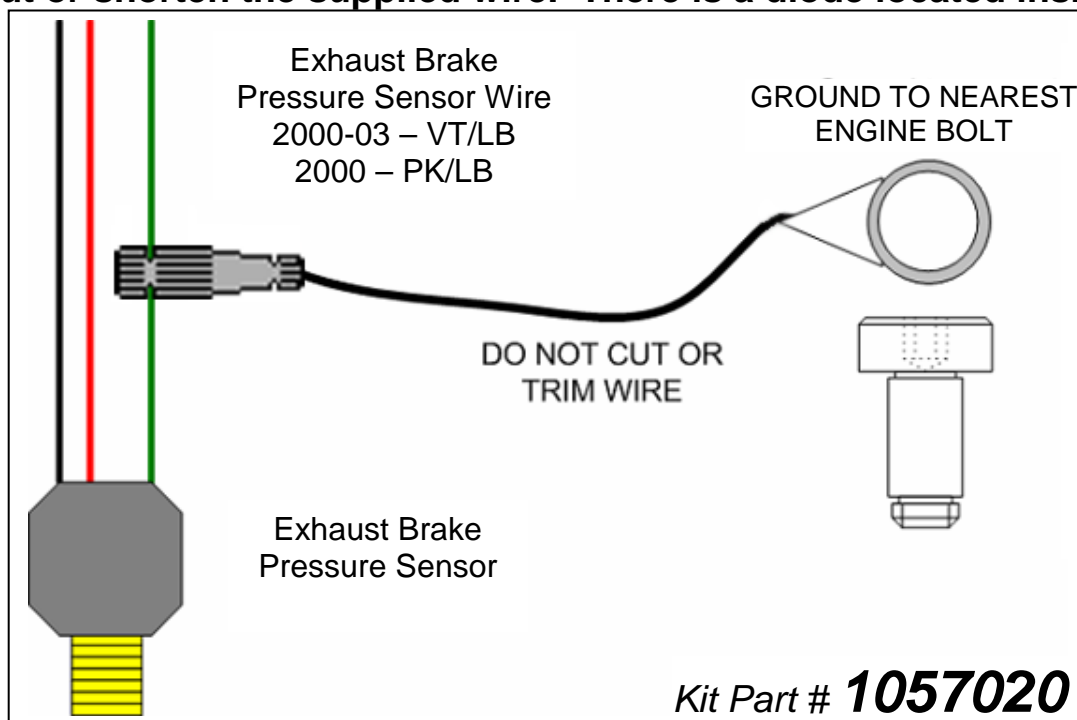

Maintenance & Trouble Shooting

To extend the life of the exhaust brake, do not operate the vehicle for extended periods of time without activating the brake. On a twice-yearly interval, check and adjust the brake pressure to 10-15 lbs while the engine is at idle. The hoses, wires, fittings and clamps should be inspected on a regular basis for any deterioration, damage, or leaks.

By following the diagrams in this manual, trace hoses and wiring, check continuity through electric components, and check for any lines that are disconnected.

This should solve any problems that may arise but if you should need any assistance or need replacement parts, call our **Technical Service** department at 1-800-887-5030 or 1-604-853-6096, between 8:30am and 4:30pm Pacific Time.

Operating Guidelines

Thank you for taking interest in the BD Engine Exhaust Brake. As a driver, you probably already know the need for extra braking power that your vehicle requires on the hills and long grades. With loads being towed behind you, the extra push when slowing down or maintaining speed on downward grades can prove to be a great strain on the vehicle hydraulic braking system, even to point of “burn-up”.

These guidelines were designed to offer a better understanding of the benefits of using exhaust brakes and are based on material developed by the US Department of Transportation National Highway Traffic Safety Administration.

The emphasis on today's vehicles is to give the consumer a product that can give them usable power with fuel efficiency. But, in the transition, the vehicles have lost their natural braking power, making it more easy for the vehicle to continue to roll and harder to stop. Of course, this gets more noticeable with the increase of weight, on or behind the vehicle. This is where an exhaust brake becomes a useful tool in increasing the driveline drag of the vehicle without the use of the hydraulic brakes.

It is a tool that with maximum use, or even occasional use, can reduce wear on hydraulic braking parts and at the same time increase safety. The BD Exhaust Brake can be used to help maintain a controlled vehicle speed on a downward grade, as well as slowing the vehicle down for such times as turns or exit ramps, without you using your hydraulic brakes. **However, the exhaust brake cannot be used as a parking brake or a service brake to bring your vehicle to a complete stop.**

By using a BD Exhaust Brake, the life and effectiveness of your hydraulic brakes will increase. This is because of the decreased use of the hydraulic brakes in situations

BD Engine Brake Inc.

Plant Address: 33541 MacLure Rd. Abbotsford, BC, Canada V2S 7W2

U.S. Shipping Address: 88-446 Harrison St, Sumas, WA 98295 U.S. Mailing Address: P.O. Box 231, Sumas, WA 98295

Phone: 604-853-6096 | Fax: 604-853-8749 | Internet: www.bd-power.com

like hills, the wear factor is reduced and there is less opportunity for your hydraulic brakes to heat up which would reduce the efficiency.

When you ride your hydraulic brakes, make hard stops or have poorly adjusted brakes, this creates high temperatures and as your brakes get hotter, the more chance there is for fading or failure. With terrain that is a series of up and down grades, the BD Exhaust Brake will aid in reducing exhaust valve warpage. Because of the power needed to pull your vehicle and load up a hill, this generates a lot of heat.

When you have reached the crest of the hill and are now coasting down the other side, the heated valves are too quickly cooled. With the exhaust brake engaged, the heat loss to the valves will be reduced, which can prevent valve warpage. When the toggle switch is turned to the “On” position, the valve is activated every time the driver takes his foot off of the throttle pedal. When the driver puts pressure back on the throttle pedal, the relay is activated and the valve opens again.

Exhaust brakes are designed to operate with the throttle at idle, not to be used in conjunction with cruise controls, and not designed to aid in gear shifting. Such cases could cause damage to engine and/or the exhaust brake. Vehicles may require downshifting to obtain the necessary retarding force.

Automatic transmissions with lock-up clutches in the converters can achieve the best retarding force with the use of a clutch control device (i.e. AutoLoc).

During cold weather engine start up, turn the brake on at idle while warming up the vehicle. This brings up the engine to normal operating temperature in much less time. Incorporated with the BD Exhaust Brake, there is a pressure regulating system that will control the created backpressure. If the backpressure reaches the set limit, the exhaust valve will open slightly to relieve the excess pressure.

The brake pressure at idle is required to be checked and adjusted at time of installed, two weeks after installed, and on a regular twice a year interval.

Using a standard pressure gauge and the pressure port on the exhaust valve, the brake pressure at idle must be set between 10 and 12lbs. The best scenario for exhaust braking is when going down hill, select a gear that lets you maintain a constant speed with little or no use of the hydraulic brakes, or, the same gear that would be used to go up the same grade of hill. This also depends on the weight, load or road conditions that the vehicle will come upon.

Therefore, in summary, by using the BD Exhaust Brake, you reduce the need for use of your hydraulic brakes in situations where you need to slow down or maintain (i.e. hills, off ramps, corners, approaching speed changes or traffic lights). By reducing the use of your hydraulic brakes in these situations, this reduces heat

BD Engine Brake Inc.

Plant Address: 33541 MacLure Rd. Abbotsford, BC, Canada V2S 7W2

U.S. Shipping Address: 88-446 Harrison St, Sumas, WA 98295 U.S. Mailing Address: P.O. Box 231, Sumas, WA 98295

Phone: 604-853-6096 | Fax: 604-853-8749 | Internet: www.bd-power.com

build-up, and wear and damage to linings and drums. And, when you reduce these factors, you save your hydraulic brakes for when you really need them (i.e. for stopping or emergencies).

The BD Exhaust Brake is not a substitute for your hydraulic brakes and, cannot correct or compensate for poorly maintained or misadjusted brakes. But, when you need to slow down or maintain a constant speed, the BD Exhaust Brake will be a valuable and effective tool. Exhaust Brakes are more efficient at preventing than correcting an over-speed condition.

To prevent the butterfly from sticking due to carbon build up and increase the life of your exhaust brake we recommend daily use. This could simply be switching it on and off a couple times a day.

Thank you and happy motoring,

BD Engine Brake, Inc.

BD Engine Brake Inc.

Plant Address: 33541 MacLure Rd. Abbotsford, BC, Canada V2S 7W2

U.S. Shipping Address: 88-446 Harrison St, Sumas, WA 98295 U.S. Mailing Address: P.O. Box 231, Sumas, WA 98295

Phone: 604-853-6096 | Fax: 604-853-8749 | Internet: www.bd-power.com