



Truck and Jeep Accessories

KJ04520BK
2007 and UP Jeep Wrangler JK
Body Lift 2 Door and 4 Door



www.Daystarweb.com
Tech Support Contact Info
Tech@DaystarWeb.com

Phone: 623.907.0081
Fax: 623.907.0088
841 South 71st Avenue
Phoenix, AZ 85043

Instruction Sheet: P11260-03
2013 Daystar Products
International Inc.

Revision: 3
Revision Date: 01/21/2014
Revised by: TY



Introduction

is your number one source for Made In The USA quality, Comfort Ride™ leveling kits. Now backed with our exclusive *Go Everywhere* © Lifetime Limited Warranty (see terms at Daystarweb.com). To assure your safety and proper installation of this product, take a moment to read all instructions and Product Safety Information before trying to install your Daystar® product. Current OEM suspension design is complex: meaning safe and proper installation requires understanding OEM service techniques for disassembly and assembly of the components indicated together with the instructions and warnings set out below and in the OEM service manual and your owner's manual. *Daystar® strongly recommends seeking advice from or having this product installed by a professional mechanic who can inspect your suspension, confirm compatibility with your tire and wheel choice and, if needed, reset alignment to optimize your steering and the features of your Daystar® Comfort Ride kit.* We are here to help if you have remaining technical questions after reading

Product Safety Information

Throughout these instructions important safety information is generally preceded by one of three signal words indicating the relative risk of injury. The signal words mean:

! WARNING A hazardous situation which, if not avoided, could result in death or serious injury. You can be Killed or Seriously Hurt if you don't follow instructions.

! CAUTION A hazardous situation which, if not avoided, could result in minor or moderate injury. You can be moderately HURT and also may suffer property damage if you don't follow instructions.

NOTICE Careful attention is required to this instruction or operation but does generally not relate to personal injury. Damage to your product or other property may result if you don't follow instructions.

!WARNING

Familiarize yourself with all vehicle manufactures' and Daystar warnings, instructions and limited warranties before driving your modified vehicle. Also be aware many states / countries have laws governing on-road vehicle heights and modifications. You are responsible for assuring the safety and legality of your vehicle. A summary of current state vehicle laws is available at www.sema.org.

Tools Needed

Quantity	Description
2	Frame Jack stands
1	Floor Jack
1	5/8 Wrench
1	16 mm Socket
1	18 mm Socket
1	1/2" Ratchet
1	1/2" Socket Extension
1	Phillips screw driver
1	Torque wrench
1	2"X 4"X 12" jacking block
1	4"X 4"X 8" jacking block

Part List

Quantity	Part Number	Description
12	M03763	Body lifts
24	S11082	Stud extenders
1	P11153	Thread lock
1	P21138	Daystar Decal
1	P10474	Warning Decal

!Warning: Always work with appropriate personal safety gear including safety glasses, gloves and hearing protection if using air powered tools.

Begin by inspecting the components & hardware for damage. Then compare components & hardware to the bill of materials for completeness. If anything is missing/damaged, do not proceed with the installation. Please, call Daystar Products (800-595-7659) and we will send you the missing or damaged components free of charge.

!Caution: Vehicle must be raised to install Body lift kit. Using a hydraulic chassis lift will greatly ease installation. If another jack is used, assure vehicle is level on a firm surface, in park (1st gear), rear wheels blocked and jack stands in place to support vehicle in case jack or vehicle shifts.



Installation Note:

This kit will only fit Jeeps with an AUTOMATIC transmission.

Installation steps

1. The tools needed for installation and a list of parts included in the kit are listed on page 2. Make sure you have all of the proper tools and understand these directions before proceeding.
2. When working on 2009 and up 2dr & 4 door model jeep, you will have 2 extra mounts and 4 extra stud extenders.

- Place Jeep on a level ground. Open the hood and use a Phillips screw driver to twist the center of the push pin insert to release and remove the six push pin fasteners (1), release the lower clips(3) and separate the grille from the Jeep and disconnect the electrical connectors (4).

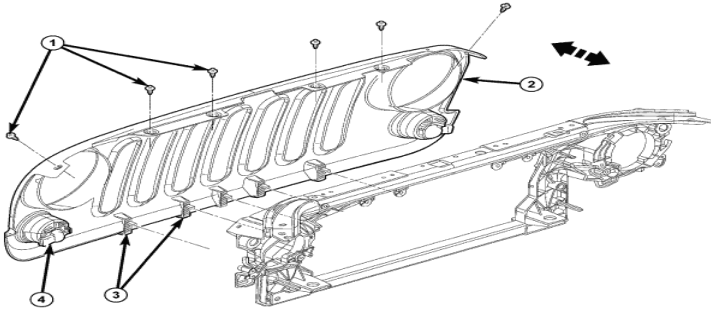

8197464

- With a 16mm socket loosen the two nuts at each of the front core support body mounts, Then with a 18mm socket loosen the bolts at the right and left sides of frame body mounts. **NOTICE:** DO NOT remove nuts at this time. **NOTICE** a 2dr will have 10 mount and a 4 door will have 12 mount locations.

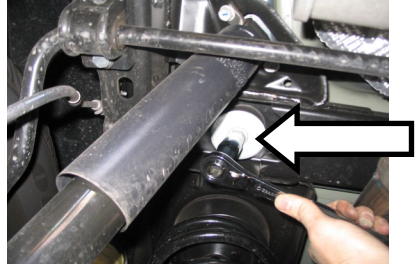
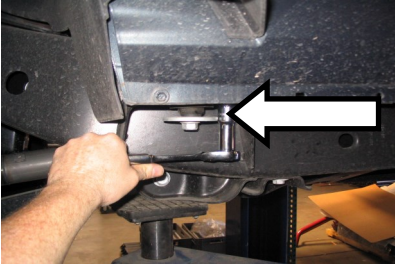

- Place the floor jack under the Jeep tub between the front and rear wheel. Rise up the jack with the 2x4 jacking block on top of the jack and remove only one side at a time of the bolt and nuts from the Jeep mounts.

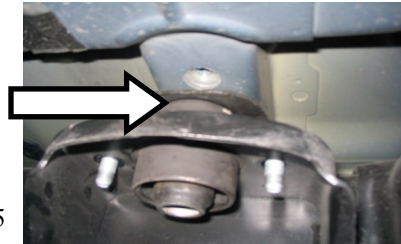
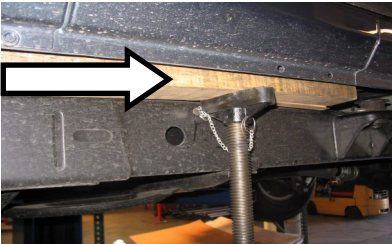

5

6. Slowly raise up the jeep with the jacking block between the jack and the tub of the jeep, about 4" off the body mounts and place a 4x6 jacking block between the frame and the jeep tub. Remove one mount at a time.

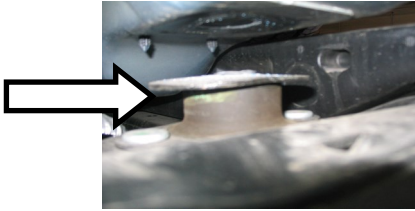

7. Place thread lock on the stud extenders.(2 at a time) Using a 5/8 wrench install the extenders on the body mount and tighten down.

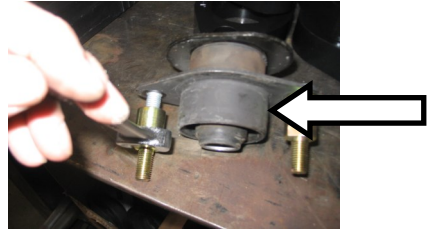
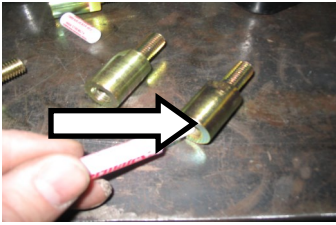

8. With the extenders tight install the body mount spacer over the stock mount.

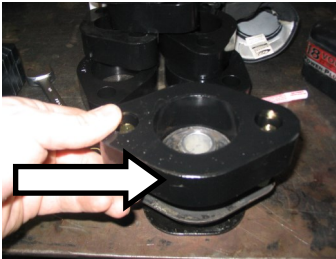

9. With the spacer mount installed. Install the mount into the fame support.
NOTICE: When installing the front grill mount put the 2 studs in grill frame first, using the 2 studs and nut to hold the mount in the grill.

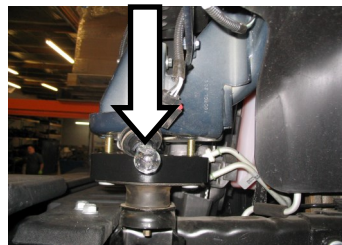
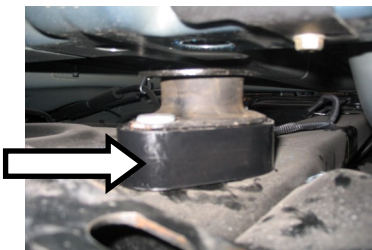

10. Repeat steps 7 to 9 with the remainder of the mounts on this side.
11. After you have installed on one side remove the 4x6 jacking block and lower down the Jeep tub onto the body mounts and install the 2 nuts and 1 bolt per mount and had tighten down and move the floor jack over to the other side and repeat steps 5 threw 10. If all the mounts have been installed, remove the 4x6 jacking block and lower jeep tub onto the body mounts.

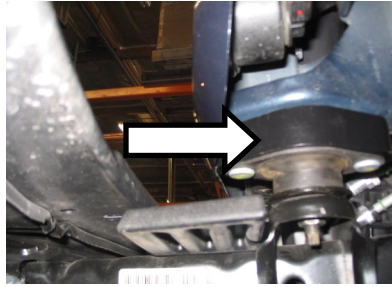
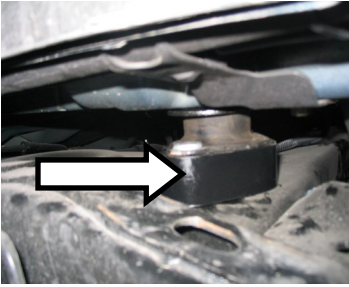

12. With all the body mount spacers installed remove the floor jack. use a 16mm socket and tighten all the 2 nuts per mount down to 40 ft lbs. Using a 18mm socket tighten down the 1 bolt per mount down to 80ft lbs.
13. Connect the electrical connectors(4) and position the grill(2) onto the front end of the grill support and seat the clips(3) fully. Install the push pin fasteners(1).

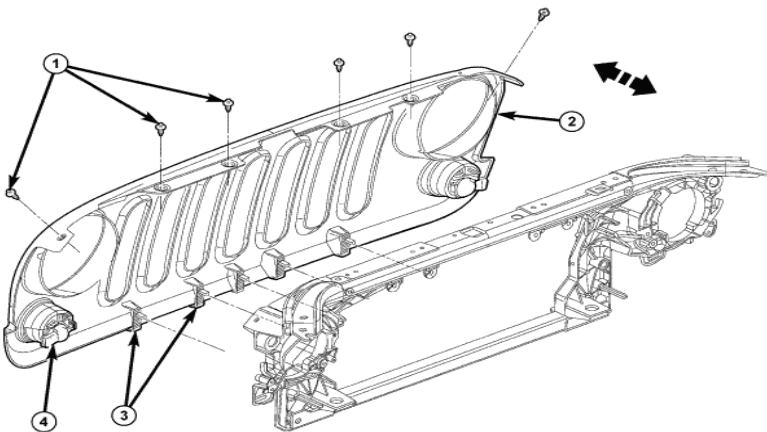

81974f04

14. Close the hood .
15. Check that all the bolts and nuts are tighten down to spec.
16. On 2010 and up JK you will need to cut 2 flat notches in the 2 rear body mount bolts as seen in photo so the washer will not hit the nuts.
17. Check all bolt and nuts after 500 miles.

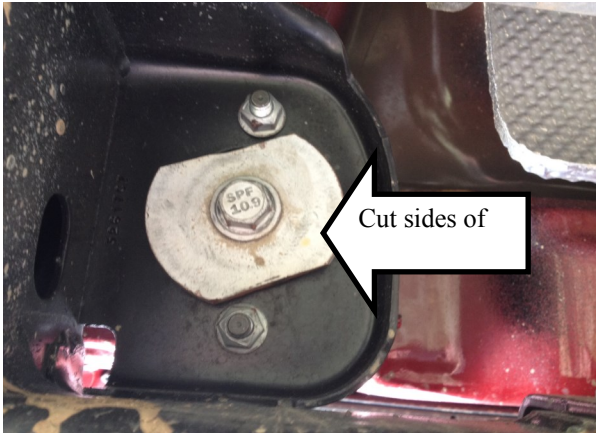

18. With the vehicle on the ground cycle the steering wheel side to side and inspect suspension components, brake lines and tires to ensure there are not any clearance issues. Jounce the suspension to assure front suspension operates freely, brake lines retain proper slack at full extension and that they remain clear of springs or other obstructions.
19. Install **“Warning to Driver”** decal on the vehicle’s sun visor or dash. The decal must be placed in a conspicuous location. Anyone that operates the vehicle must be made aware of the changes made..
20. After 500 miles of driving re-torque all of the hardware associated with the Body lift kit installation to ,factory specifications. Repeat torquing procedure as required.



Truck and Jeep Accessories

Daystar® Lifetime GoEverywhere Limited Warranty

Your Daystar® Comfort Ride or Budget Boost leveling kit is covered by the following ***Go Everywhere Lifetime Limited Warranty*** provided exclusively by Daystar Products International, Inc., 841 South 71st Ave., Phoenix, AZ 85043 (“Daystar”).

What is Covered? Real Life Use, Off Road & On: Subject to the terms, exclusions and limitations herein, Daystar® warrants to the initial retail purchaser that your Comfort Ride™ or Budget Boost™ leveling kit shall be free of defects in material and workmanship for so long as it is properly installed on a single vehicle owned by the initial retail Daystar® purchaser.

What is Not Covered? Your Vehicle & Parts Not Daystar’s GoEverywhere:

Your Daystar **Limited Warranty** does not cover: (a.) damage to your vehicle, vehicle systems (ex. electronic stability control) other products, components or property not manufactured by Daystar to our exclusive *GoEverywhere* standards, (b.) customer choice of vehicle configuration/tire and wheel combinations contrary to Daystar® recommendations, warnings or applicable laws, (C.) Acts of God, weather, corrosion, accidents, theft, vandalism, negligent misuse or intentional damage, other exclusions under your OEM Limited Warranty.

Remedy Limited to Repair/Replacement. Get back on your favorite trail fast. The exclusive remedy provided hereunder shall, upon Daystar’s inspection and option, be either repair or replacement of the Comfort Ride™ or Budget Boost™ leveling kit or parts covered under this **Limited Warranty**. Call us and we will get you back wheelin’ (623/907-0081). All labor, removal, shipping and installation costs are customer’s responsibility.

Other Exclusions –Limitation of Damages - Your Rights Under State Law. Stuff Lawyers Say.

At Daystar® we aren’t big fans of lawyers, even ours. Still, he says our **Limited Warranty** has to include this stuff. In consideration of the purchase price paid, neither Daystar® nor any independent Daystar® distributor or repair person are responsible for any time loss, loss of vehicle use, rental costs, transportation, labor or for any incidental, consequential, punitive or other damages you may have or incur in connection with any part or product purchased. No Daystar® employee or independent distributor is authorized to make any statement or representation altering the terms of Daystar’s *GoEverywhere Lifetime Limited Warranty*. **Your exclusive remedy hereunder for covered parts is repair/replacement as described above.** This **Limited Warranty** gives you specific rights. You may also have other rights that vary from state to state. For example, some states do not allow limitations of how long an implied warranty lasts and/or do not allow the exclusion or limitation of incidental or consequential damages, so the limitations and exclusions herein may not apply to you.

All other warranties are hereby disclaimed, except to the extent prohibited by applicable law in which case any implied warranty of merchantability, fitness for a particular purpose or other implied warranty are limited to a period of four (4) years from date of initial retail purchase. Daystar® reserves the rights to: (a.) require invoice or other proof of purchase; (b.) make future revisions to these products and **Limited Warranty** without prior notice or obligation to upgrade your Daystar® product.

© Daystar Products International, Inc., 9.15.13. All rights reserved.





Truck and Jeep Accessories

CARRY MORE WITH CAM CANS

SAFE & SECURE FLUID & GEAR STORAGE

NEW



Cam Can Trail Box

- KU711140R Cam Can Trail Box (Trail Box Only) \$69.99
- KJ710350R Cam Can Trail Box (Jeep Complete Kit) \$129.99
- KT710010R Cam Can Trail Box (Toyota Complete Kit) \$129.99



Cam Can Universal Mounting Kit

KU71118 Mount your Cam Can on the garage wall, trailer or any other flat surface. \$49.99



Double Cam Can Mount

KU71116 Double-mount kit available. Includes a longer center shaft and allows you to stack two Cam Cans together on the mounting plate. \$19.99



A. Cam Can Drinking Water

- KU71114RB (Cam Can Only) \$59.99
- KJ71035RB (Jeep Complete Kit) \$119.95
- KT71001RB (Toyota Complete Kit) \$119.95

B. Cam Can Fluids (Non-Fuel)

- KU71114GN (Cam Can Only) \$59.99
- KJ71035GN (Jeep Complete Kit) \$119.95
- KT71001GN (Toyota Complete Kit) \$119.95

AS EASY AS...



AIR BAG CRADLE

MADE FROM EXTREMELY TOUGH DAYSTAR PTMEG POLYURETHANE **KU09140BK \$79.99**

Get all the benefits of an air bag cradle whether you are towing a heavy load or not



GO EVERYWHERE

daystarproducts.com 800-595-7659



Truck and Jeep Accessories

ESTABLISHED IN 1977



LIKE US

SHARE US

WATCH

FOLLOW US



Instagram 12

