

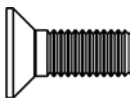



2x  M6-1.0 x 16mm Lg.

2x  M6-1.0 x 16mm Lg. SHCS

8x  M8-1.25 x 20mm Lg. SHCS

2x  M6 Flat Washer

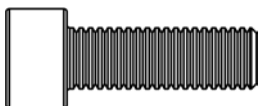
6x  M8-1.25 x 25mm Lg. SHCS

6x  M8 Flat Washer

Need help with your installation?

Read instructions and view illustrations before beginning.



sales@superatv.com



www.superatv.com



1-855-743-3427



8:00am - 9:00pm EST M-Th
 8:00am - 7:00pm EST Friday
 9:00am - 2:00pm EST Saturday

*Thank You
 For Choosing*



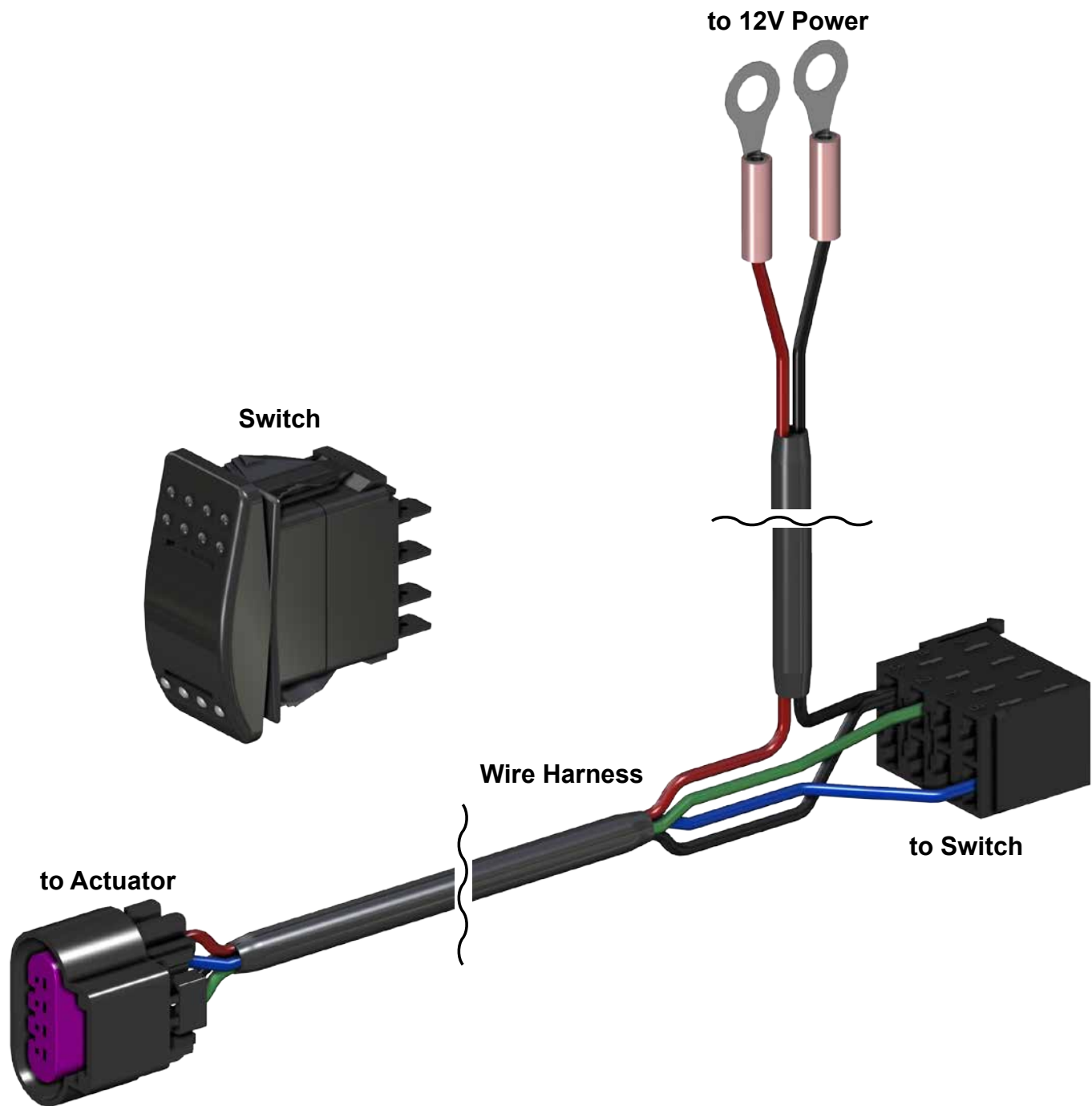

Liability Statement

SuperATV's® products are designed to best fit user's ATV/UTV under stock conditions. Adding, modifying, or fabricating any factory or aftermarket parts will void any warranty provided by SuperATV® and is not recommended. SuperATV's® products could interfere with other aftermarket accessories. If user has aftermarket products on machine, contact SuperATV® to verify that they will work together.

Although SuperATV® has thousands of satisfied customers, user should be aware that installing lift kits, long travel, or suspension kits, tires, etc. will change the ride of machine and may increase maintenance and part wear. Operating any off-road machine while, or after, consuming alcohol and/or drugs increases risk of bodily harm or death. No warranty or representation is made as to this product's ability to protect user from severe injury or death. SuperATV® urges operators and occupants to wear a helmet and appropriate riding gear at all times.

By purchasing and installing SuperATV® products, user agrees that should damages occur, SuperATV® will not be held responsible for loss of time, use, labor fees, replacement parts, or freight charges. SuperATV®, nor any 3rd party, will not be held responsible for any direct, indirect, incidental, special, or consequential damages that result from any product purchased from SuperATV®. The total liability of seller to user for all damages, losses, and causes of action, if any, shall not exceed the total purchase price paid for the product that gave rise to the claim.

SuperATV® will warranty only parts provided by SuperATV®. Any damage or problems with OEM housings, bearings, seals, or other manufacturers' products will not be covered by SuperATV®. SuperATV® parts and products are not warranted if item was not installed properly, misused, or modified.

Installing, adding, modifying, or fabricating any factory or aftermarket product to your ATV/UTV may violate certain local, state, and federal laws. Be advised that laws vary depending on town, city, county, state, etc. Use of certain products on public streets, roads, or highways may be in violation law. The Buyer is solely and exclusively legally and personally responsible for any violation of the law by the installation or use of the product. You must abide by all local, state, and federal laws, including but not limited to vehicle safety, traffic laws, and ordinances. It is your responsibility to know the laws and how they apply to you.

The Buyer is responsible to fully understand the capability and limitations of his/her vehicle according to manufacturer specifications, warnings and instructions and agrees to hold SuperATV® harmless from any damage resulting from failure to adhere to such specifications, warnings and/ or instructions. The Buyer is also responsible to obey all applicable federal, state, and local laws and ordinances when operating his/her vehicle while using this product, and the Buyer agrees to hold SuperATV® harmless from any violation thereof.

Removal





remove Lid



loosen (8) bolts on Clutch Pack



separate Clutch Pack from Ring Gear



remove (2) countersunk screws from Clutch Pack



do not use impact wrench

remove components shown





remove Snap Ring
from one end

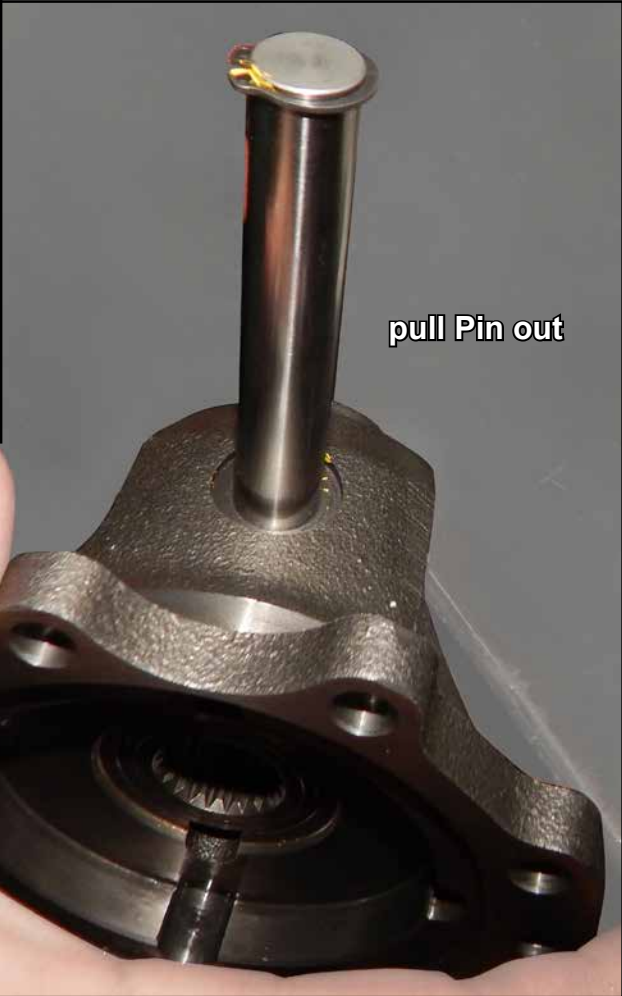

pull Pin out



2x- Shim



replace stock plastic Shims
with provided metal Shims



do not replace if OE Shims are metal

install provided Splined Plate



install provided Splined Hub



*apply blue thread locker to all hardware shown
and do not use impact wrench when installing*

**secure Ring Gear Plate to OE Carrier Half
with hardware shown**

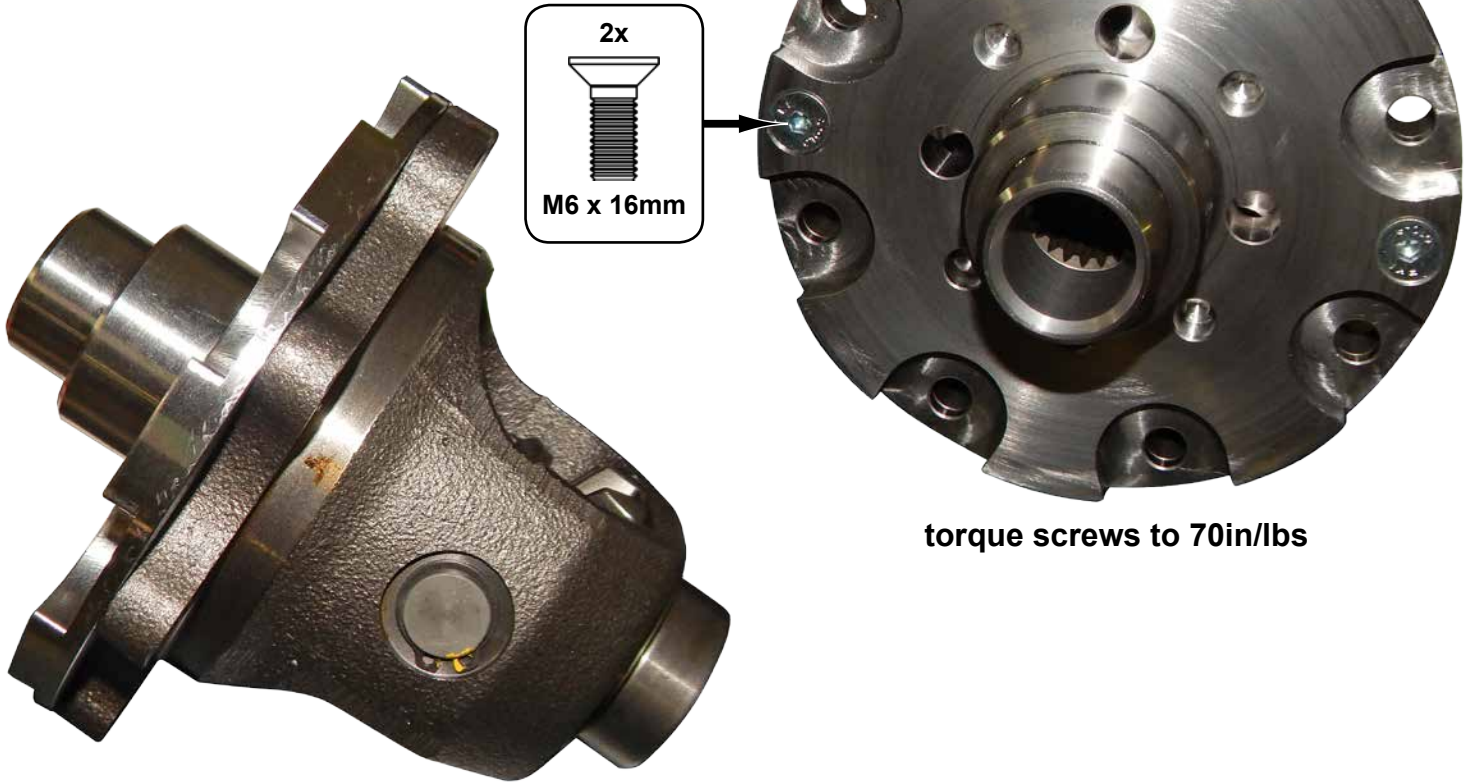

torque screws to 70in/lbs

install Ring Gear Plate to Ring Gear with hardware shown

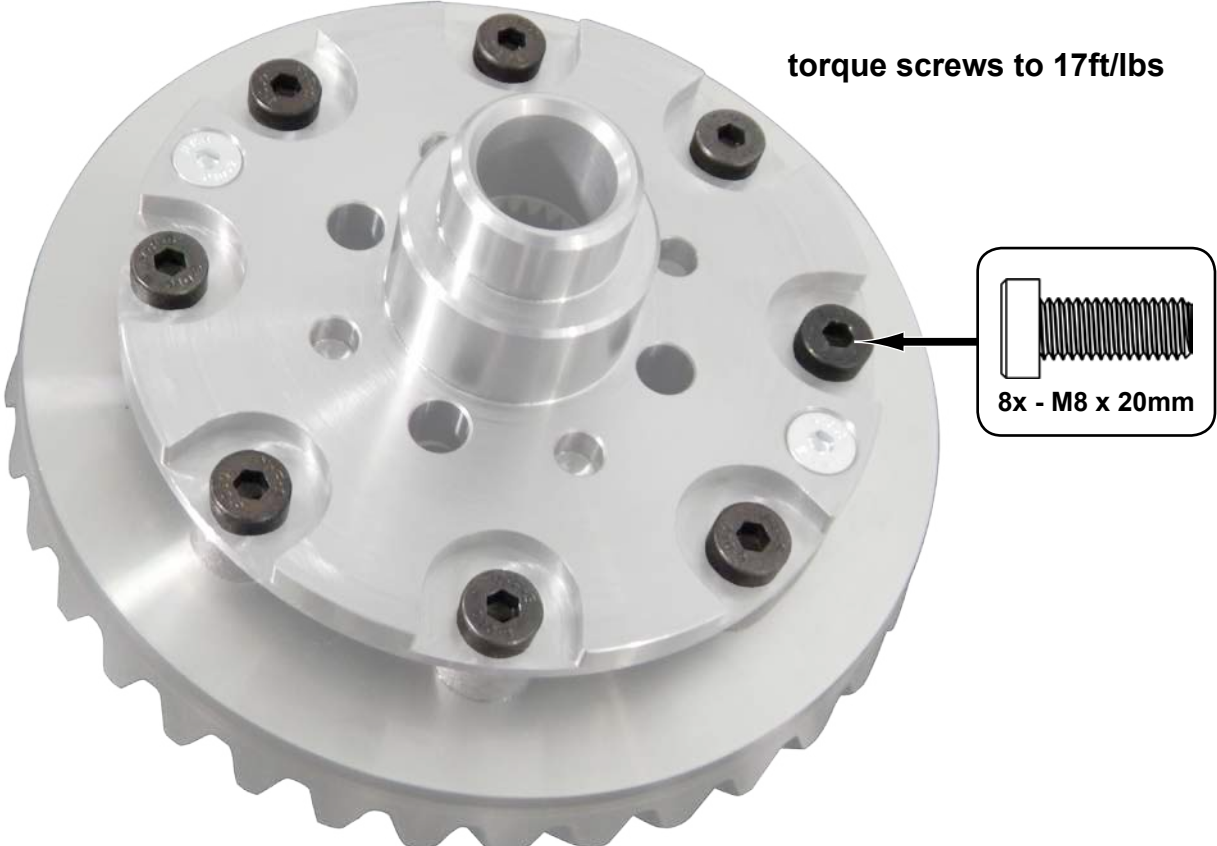

torque screws to 17ft/lbs



install OE Shim



place Springs onto Lid

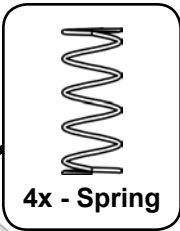

4x - Spring



**place Ring Gear Plate/OE Carrier Half
assembly onto Lid**

secure Lid with hardware shown

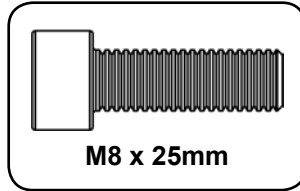

M8 x 25mm

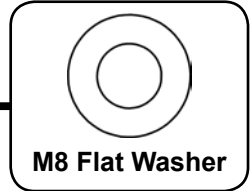

M8 Flat Washer

6 each

apply blue thread locker to all hardware shown and do not use impact wrench when installing

torque screws to 20ft/lbs

install to machine and secure with stock hardware; torque to 40ft/lbs



front

connect vent tube

(driver)

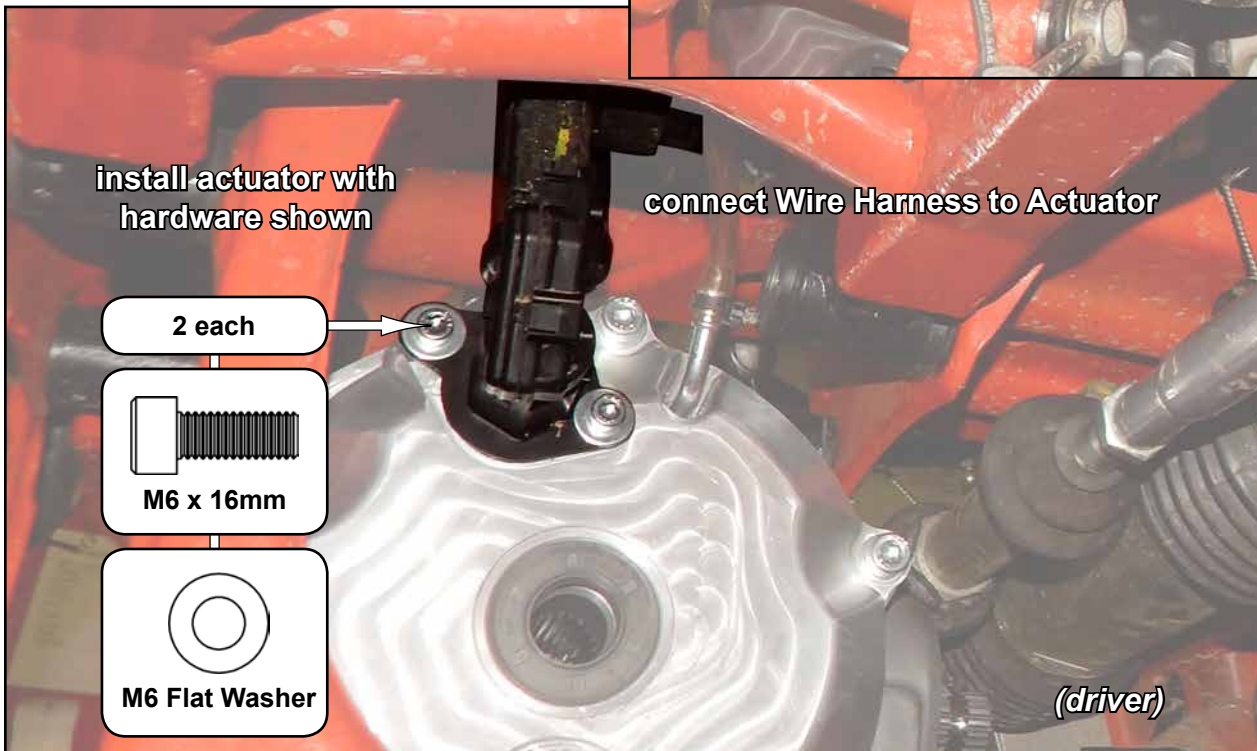

reinstall components removed previously; see page 3



- power connections can be made at OE Power Block located in area shown
- remove Passenger Seat and Console Panels to access

