



**DOWNLOAD ENHANCED
INSTALL MANUALS AT
*dieselperformance.com***



BD FORD 6.0L PERFORMANCE
EXHAUST MANIFOLD
Installation Instructions

Application List

Ford Powerstroke 2003-07	6.0L	1041480
---------------------------------	-------------	----------------

PLEASE READ ALL INSTRUCTIONS BEFORE INSTALLATION

UNLESS AN EO# IS LISTED, THIS PRODUCT IS LEGAL IN CALIFORNIA FOR RACING VEHICLES ONLY, WHICH MAY NEVER BE USED UPON A HIGHWAY.

BD Engine Brake Inc.





Plant Address: 33541 MacLure Rd. Abbotsford, BC, Canada V2S 7W2

U.S. Shipping Address: 88-446 Harrison St, Sumas, WA 98295 U.S. Mailing Address: P.O. Box 231, Sumas, WA 98295

Phone: 604-853-6096 | Fax: 604-853-8749 | Internet: www.bd-power.com

KIT CONTENTS:

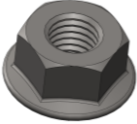
Please check to make sure that you have all the parts listed in this kit **before** you start the disassembly of your truck.

Ford 2003-08 Performance Manifold (BD# 1041480)		
1401480-1	1401480-2	1200208
		
<i>Passenger side manifold</i>	<i>Driver side manifold</i>	<i>1/8" NPT Brass Plug</i>
Qty: 1	Qty: 1	Qty: 1
1900014	1900013	
		
Flange nut	Flange bolt 60 mm Long	
Qty: 4	Qty: 4	

Options

Description	Part #
Ford 6.0L Manifold Gasket Set	Ford Part # 6C3Z9448-A
Ford 6.0L Manifold Bolts	Ford Part # 3C3Z9S425AA
Ford 6.0L Manifold Spacers	Ford Part # 3C3Z9A461AA
Ford 6.0L Exhaust pressure tube adapter	Ford Part # 3C3Z9D477BA

BD Engine Brake Inc.

Plant Address: 33541 MacLure Rd. Abbotsford, BC, Canada V2S 7W2

U.S. Shipping Address: 88-446 Harrison St, Sumas, WA 98295 U.S. Mailing Address: P.O. Box 231, Sumas, WA 98295

Phone: 604-853-6096 | Fax: 604-853-8749 | Internet: www.bd-power.com

Removal

(Driver side)

1. Position vehicle on a hoist and chock wheels to prevent vehicle from rolling. Disconnect the Negative terminals on both batteries.

2. Remove the 2 driver side exhaust manifold to turbocharger adapter pipe nuts.

NOTE: These bolts may be easier to access if the inner fender liner is removed.

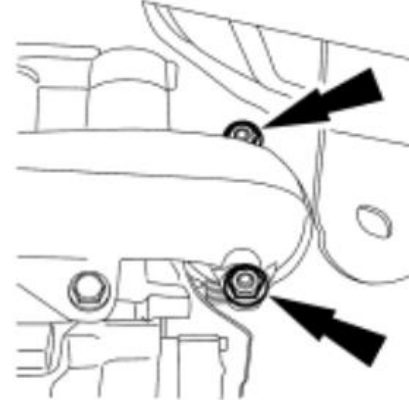

3. Disconnect the exhaust pressure tube from the driver side exhaust manifold.
4. Remove the 8 bolts, 8 spacers and the driver side exhaust manifold.

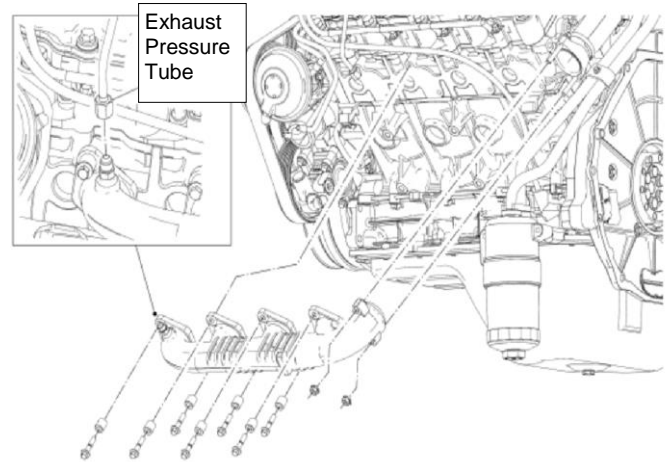

BD Engine Brake Inc.

Plant Address: 33541 MacLure Rd. Abbotsford, BC, Canada V2S 7W2

U.S. Shipping Address: 88-446 Harrison St, Sumas, WA 98295 U.S. Mailing Address: P.O. Box 231, Sumas, WA 98295

Phone: 604-853-6096 | Fax: 604-853-8749 | Internet: www.bd-power.com

(Passenger side)

5. Remove the transmission fluid indicator. Remove the retaining nut and position the transmission fluid tube off the stud. Separate the transmission fluid tube and position aside.

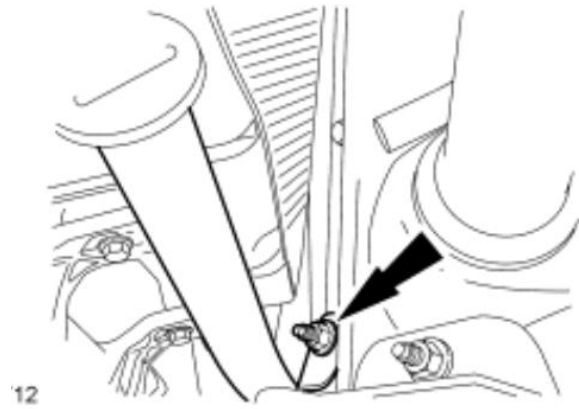

6. Remove the 2 passenger side exhaust manifold to turbocharger adapter pipe nuts.

NOTE: These bolts may be easier to access if the inner fender liner is removed.

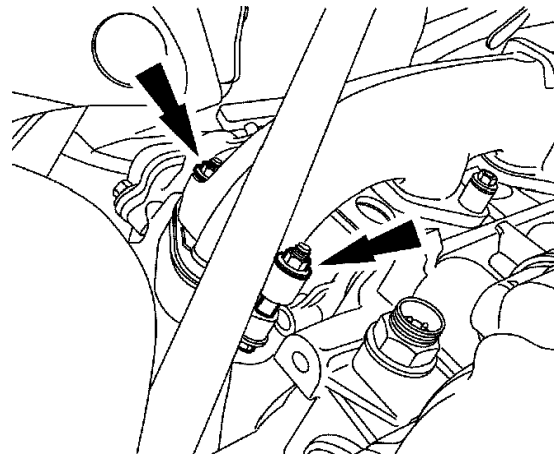

7. Remove the 8 bolts, 8 spacers and the passenger side exhaust manifold.

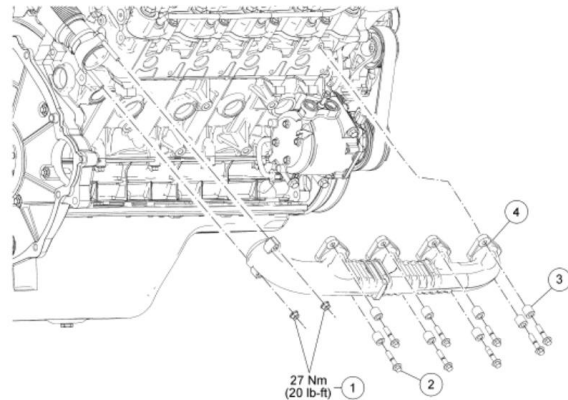

BD Engine Brake Inc.

Plant Address: 33541 MacLure Rd. Abbotsford, BC, Canada V2S 7W2

U.S. Shipping Address: 88-446 Harrison St, Sumas, WA 98295 U.S. Mailing Address: P.O. Box 231, Sumas, WA 98295

Phone: 604-853-6096 | Fax: 604-853-8749 | Internet: www.bd-power.com

Installation

Install Notes:

- ◆ Installing the bolts with the small diameter hole will assist in the alignment of the remaining bolts.
- ◆ When installing the exhaust manifolds, only use prevailing torque hex flange bolts with an interference fit.
- ◆ Apply anti-seize lubricant to the bolt threads prior to installing the bolts.

(Driver Side)

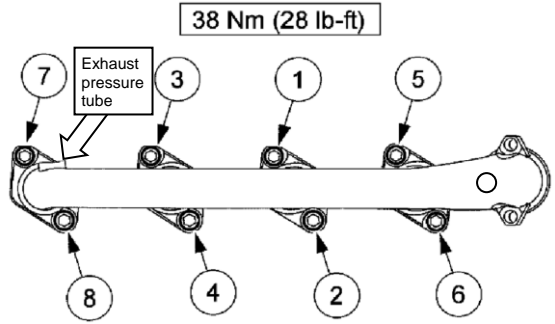
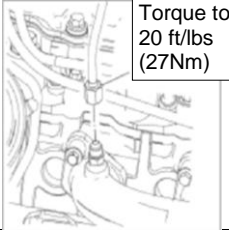
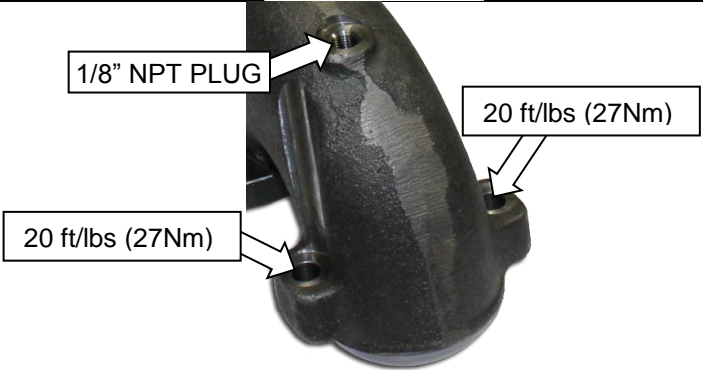
<p>1. Install the driver side exhaust manifold and tighten the OEM bolts and spacers in the sequence shown to 28 ft/lbs (38 Nm)</p>	
<p>2. Connect the exhaust pressure tube to the exhaust manifold and tighten to 22ft/lbs (30Nm)</p>	
<p>3. Install supplied driver side exhaust manifold to turbocharger adapter bolts (1900013) & nuts (1900014) and tighten to 20 ft/lbs (27Nm)</p> <p>NOTE: If no pyro is used; insert 1/8" NPT supplied plug.</p>	



BD Engine Brake Inc.

Plant Address: 33541 MacLure Rd. Abbotsford, BC, Canada V2S 7W2

U.S. Shipping Address: 88-446 Harrison St, Sumas, WA 98295 U.S. Mailing Address: P.O. Box 231, Sumas, WA 98295

Phone: 604-853-6096 | Fax: 604-853-8749 | Internet: www.bd-power.com

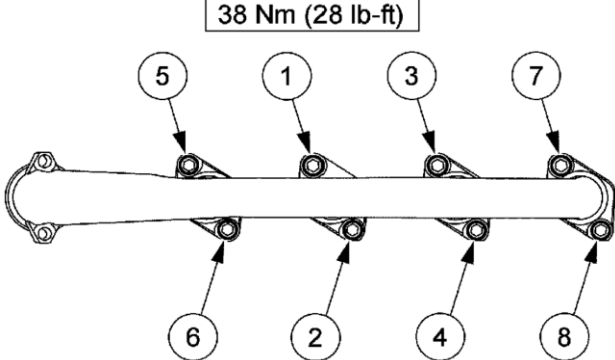
(Passenger Side)

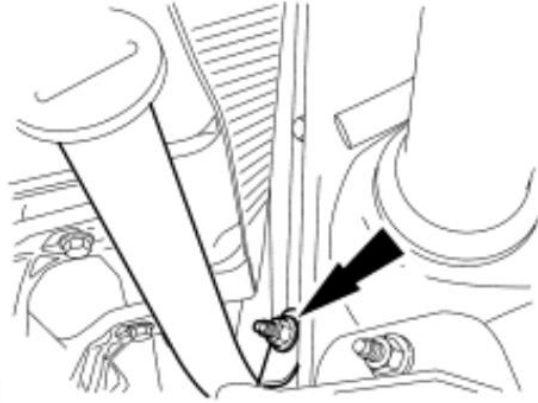
<p>4. Install the passenger side exhaust manifold and tighten the 8 OEM bolts and spacers in the sequence shown to 28 ft/lbs (38 Nm)</p>	
<p>5. Install supplied passenger side exhaust manifold to turbocharger adapter bolts (1900013) & nuts (1900014) and tighten to 20 ft/lbs (27Nm)</p>	
<p>6. Reconnect the transmission fluid tube and position the tube on the stud; install the retaining nut. Re-insert the transmission fluid indicator.</p>	
<p>7. Reconnect the negative terminals on both batteries and check for exhaust manifold leaks. Installation is complete.</p>	