

Load**LIFTER** 5000™ **ULTIMATE**

ADJUSTABLE AIR HELPER SPRINGS

TOW AND HAUL WITH SAFETY AND COMFORT™



Kit Numbers **88268 and 88284**



CAUTION

READ PAGE 14 BEFORE
INSTALLATION

INSTALLATION GUIDE

For maximum effectiveness and safety, please read these instructions completely before proceeding with installation.

Failure to read these instructions can result in an incorrect installation.

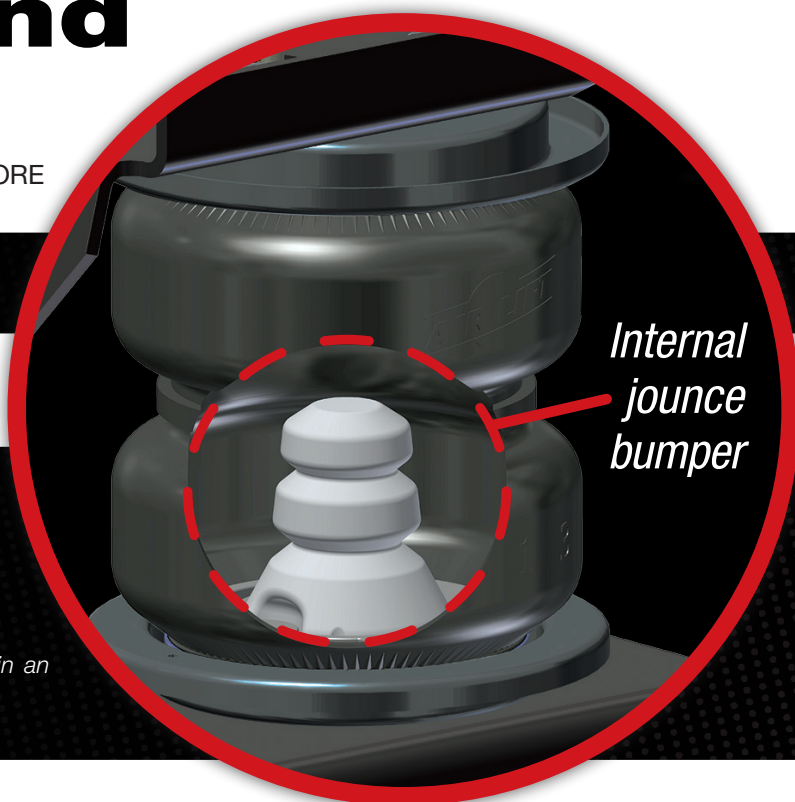

TABLE OF CONTENTS

Introduction	2
Important Safety Notice	2
Notation Explanation	2
Installation Diagram	3
Hardware and Tools Lists	4
Installing the LoadLifter 5000 Ultimate System	5
Getting Started	5
Assembling the Air Spring Assemblies	10
Installing the Air Spring Assemblies	11
Finishing the Installation	13
Installing the Air Lines	14
Checking for Leaks	15
Fixing Leaks	15
Before Operating	16
Installation Checklist	16
Post-Installation Checklist	16
Product Use, Maintenance and Servicing	17
Minimum and Maximum Pressure	17
Maintenance Guidelines	17
Troubleshooting Guide	17
Frequently Asked Questions	18
Tuning the Air Pressure	18
Guidelines for Adding Air	19
Limited Warranty and Return Policy	20
Replacement Information	21
Contact Information	21

Introduction

The purpose of this publication is to assist with the installation, maintenance and troubleshooting of the LoadLifter 5000 Ultimate air spring kit. LoadLifter 5000 Ultimate utilizes sturdy, reinforced, commercial grade single- or double-bellows (depending on the kit). The bellows are manufactured like a tire with layers of rubber and cords that control growth. An internal jounce bumper inside the spring absorbs shock and eliminates harsh jarring on rough roads. The internal jounce bumper replaces the factory bumper and allows the air springs to safely be run at zero air pressure. LoadLifter 5000 Ultimate kits are recommended for most 3/4 and 1 ton pickups and SUVs with leaf springs, and provide up to 5,000 pounds of load-leveling support with air adjustability from 5-100 PSI. The kits are used in motor home rear applications and various front applications where leaf springs are used.

It is important to read and understand the entire installation guide before beginning installation or performing any maintenance, service or repair. The information here includes a hardware list, tool list, step-by-step installation information, maintenance tips, safety information and a troubleshooting guide.

Air Lift Company reserves the right to make changes and improvements to its products and publications at any time. For the latest version of this manual, contact Air Lift Company at (800) 248-0892 or visit our website at www.airliftcompany.com.

IMPORTANT SAFETY NOTICE

The installation of this kit does not alter the Gross Vehicle Weight Rating (GVWR) or payload of the vehicle. Check your vehicle's owner's manual and do not exceed the maximum load listed for your vehicle.

Gross Vehicle Weight Rating: The maximum allowable weight of the fully loaded vehicle (including passengers and cargo). This number — along with other weight limits, as well as tire, rim size and inflation pressure data — is shown on the vehicle's Safety Compliance Certification Label.

Payload: The combined, maximum allowable weight of cargo and passengers that the vehicle is designed to carry. Payload is GVWR minus the Base Curb Weight.

NOTATION EXPLANATION

Hazard notations appear in various locations in this publication. Information which is highlighted by one of these notations must be observed to help minimize risk of personal injury or possible improper installation which may render the vehicle unsafe. Notes are used to help emphasize areas of procedural importance and provide helpful suggestions. The following definitions explain the use of these notations as they appear throughout this guide.

 **DANGER**

INDICATES IMMEDIATE HAZARDS WHICH WILL RESULT IN SEVERE PERSONAL INJURY OR DEATH.

 **WARNING**

INDICATES HAZARDS OR UNSAFE PRACTICES WHICH COULD RESULT IN SEVERE PERSONAL INJURY OR DEATH.

 **CAUTION**

INDICATES HAZARDS OR UNSAFE PRACTICES WHICH COULD RESULT IN DAMAGE TO THE MACHINE OR MINOR PERSONAL INJURY.

NOTE

Indicates a procedure, practice or hint which is important to highlight.

Installation Diagram

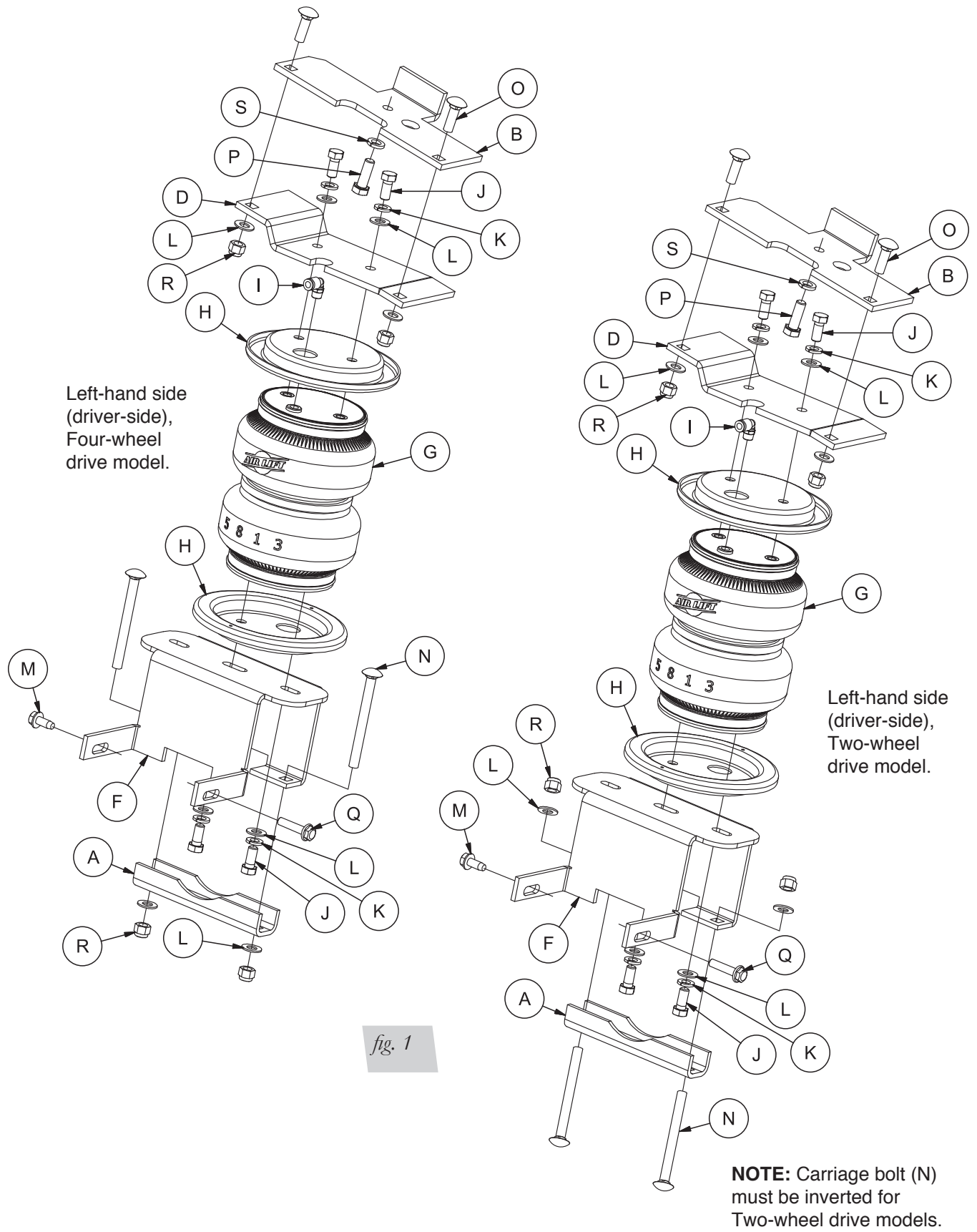

HARDWARE LIST

Item	Part #	Description	Qty			
A	01531	Clamp bar	2	N	17168	3/8"-16 x 5" carriage bolt.....4
B	07181	Left-hand frame bracket.....	1	O	17361	3/8"-16 x 1.25" carriage bolt.....4
C	07274	Right-hand frame bracket	1	P	17409	M10-1.54 X 30 hex cap screw
D	07179	Left-hand air spring upper bracket.....	1	Q	17469	M8-1.25 X 25 flange bolt.....3
E	07280	Right-hand air spring upper bracket....	1	R	18435	3/8"-16 Nylon lock nut.....8
F1	03023	Lower bracket (2WD models)	2	S	18540	M10 lock washer
F2	03024	Lower bracket (4WD models)	2	AA	20086	Air line
G	58494	Air spring.....	2	BB	10466	Tie strap.....
H	11967	Roll plates	4	CC	21230	Valve cap
I	21848	90° swivel fittings.....	2	DD	18501	5/16" flat washer
J	17203	3/8"-24 X 7/8" hex head screw.....	8	EE	21234	Rubber washer.....
K	18427	3/8" lock washer.....	8	FF*	18401	Star washer.....
L	18444	3/8" flat washer	16	GG*	21233	5/16" hex nut.....
M	17102	5/16"-18 X 3/4" self-threading screw...2				

*Not shown



Missing or damaged parts? Call Air Lift customer service at (800) 248-0892 for a replacement part.

TOOLS LIST

Description.....	Qty
Hoist or floor jacks.....	1
Safety stands.....	2
Safety glasses.....	1
Torque wrench.....	1
Standard open-end combo wrenches.....	1
Ratchet.....	1
Metric and standard sockets	1
5/16" drill bit (very sharp).....	1
Heavy-duty drill	1
Hose cutter, razor blade, or sharp knife	1
Air compressor or compressed air source.....	1
Spray bottle with dish soap/water solution	1

Installing the LoadLifter 5000 Ultimate System

GETTING STARTED

1. Lift the vehicle up and support the frame with jack stands. Leave enough room to drop the axle down low enough to install the air spring assemblies into position between the axle and the frame (Fig. 2).



fig. 2

2. In order to install the assemblies, the jounce bumpers and cups will need to be removed (Fig. 3). Figure 4 shows the driver-side frame with the jounce bumper removed.



fig. 3

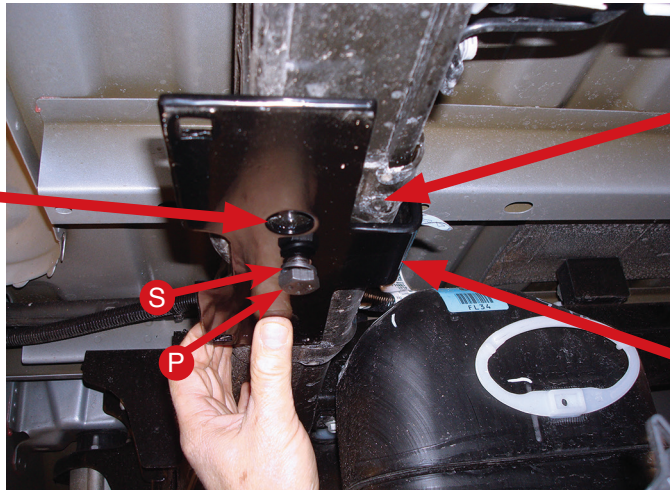

fig. 4

3. Install the left-hand (driver-side) frame bracket (B) onto the frame, ensuring that the flange is on the inside of the frame. The large hole under the bracket will be behind the axle as shown (Fig. 5). Attach with the M10 hex cap screw (P) and lock washer (S), making sure that the bracket is parallel to the ridge that is under the frame rail. Torque to 35 lb.-ft. Repeat for the right-hand (passenger) side.

The large hole in the upper bracket will be behind the axle.

fig. 5



The frame has a ridge; the bracket must be parallel to this ridge.

The flange on the bracket must be inboard of the frame.

4. In order to install the lower brackets, remove the stock M8 hardware holding the brake/ABS and emergency brake line brackets to the spring perches (Figs. 6 and 7) and pull the brackets slightly away from the spring perch.

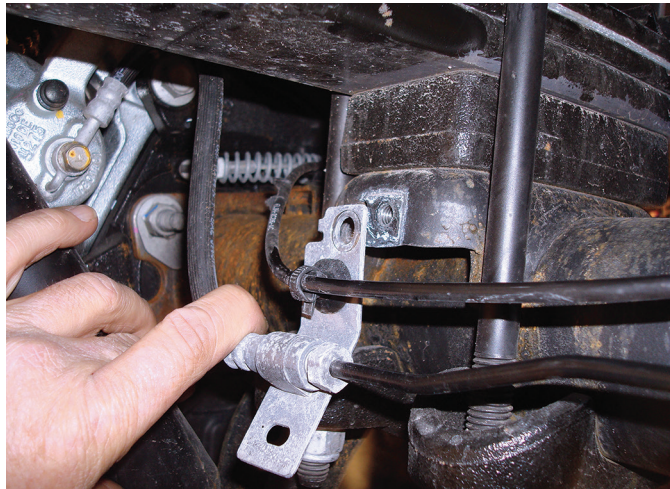

fig. 6



Emergency brake cable forward of passenger side

fig. 7

5. On the front of the driver-side spring perch there is a hole and a slot (Fig. 8). In order to mount the lower bracket it will be necessary to tap the hole using the 5/16" self-tapping bolt (M) by starting the bolt making sure it is perpendicular to the perch. Use a ratchet and socket to drive the bolt in, creating the threads in the spring perch (Fig. 9). Remove the bolt for later use.

NOTE

If you have a model, which on the passenger side, does not have an emergency brake cable bracket and mounting bolt as noted (has an open hole like noted on driver-side) Follow step 5 for this side by self-tapping the hole as specified.



It will be necessary to tap the round hole in the forward driver-side spring perch. If there is no emergency brake cable bracket and mounting bolt as specified in Fig. 7 on the passenger side, repeat and tap the round hole as

fig. 8

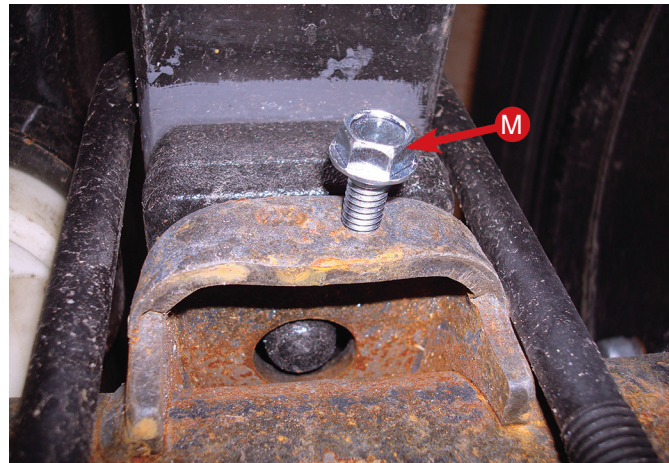
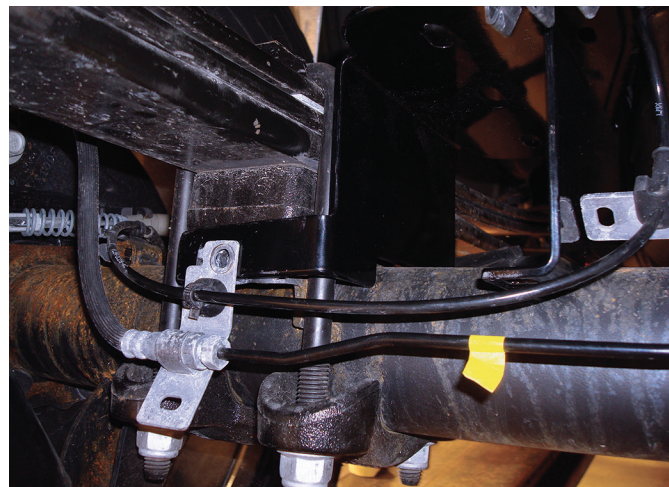

fig. 9

6. Set the lower bracket (F1 or F2) on the axle making sure the tabs wrap around the spring perch (Fig. 10). Repeat for the other side.



Note: Four-wheel drive installation shown.

fig. 10

- Index the brake line/ABS bracket alignment tabs through the lower bracket on the back of the spring perch, and reattach using the M8 flange bolt (Q) provided (Fig. 11). Also, attach the emergency brake line bracket on the front of the passenger-side spring perch in the same manner. Finish by installing the 5/16" bolt previously used to tap the forward spring perch hole and LEAVE ALL HARDWARE LOOSE AT THIS TIME.

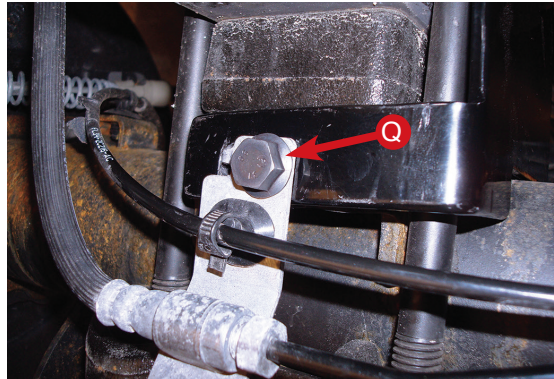

fig. 11

- For the **4WD models**, insert the long 3/8" carriage bolts (N) through the lower bracket (Fig. 12).

NOTE

Due to the tight clearance for the U-bolt to be positioned into place, it may be necessary to "rotate" or "screw" the carriage bolt into the square hole in the bracket.

Slide the clamp bar (A) over the carriage bolts and cap with a 3/8" flat washer (L) and nylon lock nut (R) (Fig. 12). Snug the nylon lock nuts down evenly until the clamp bar just makes contact with the axle. Leave loose at this time.

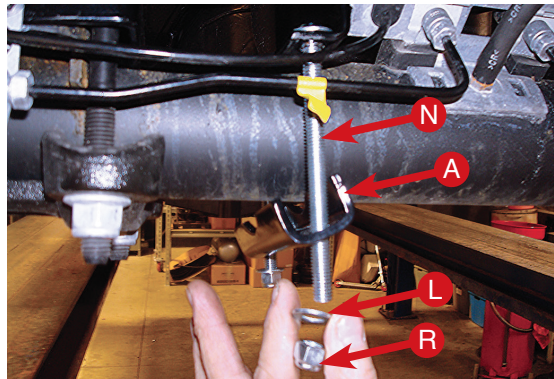

Note:
Four-wheel drive installation shown.

fig. 12

- For the **2WD models** it will be necessary to invert the carriage bolt (run it upside down) (Fig. 13).

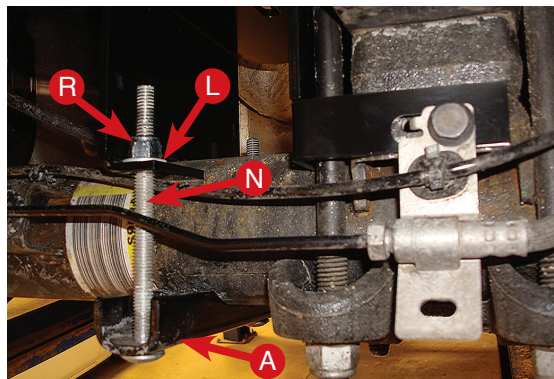

Note:
Two-wheel drive installation shown.

fig. 13

10. Once the clamp bar is snug to the axle, torque all the spring perch hardware to 20 lb.-ft. Then torque the axle clamp hardware to 15 lb.-ft. Figures 14-17 (four-wheel drive) and 18-21 (two-wheel drive) show the lower bracket once it has been mounted to the axle.

Four-wheel drive models with lower bracket installed:

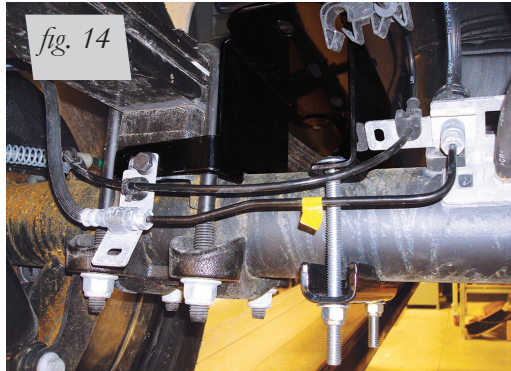

Driver-side rear view

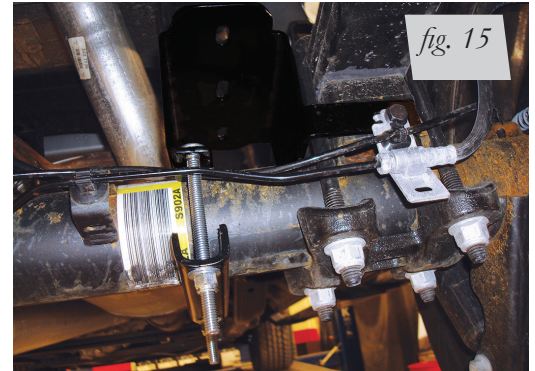

Passenger-side rear view

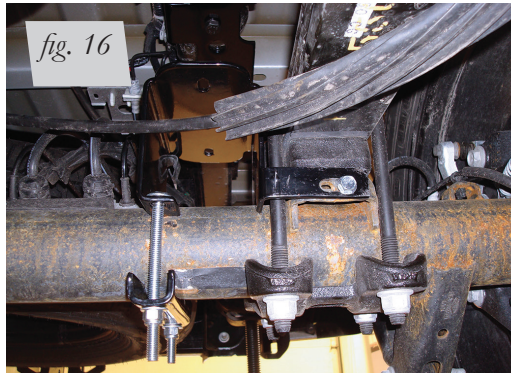

Driver-side front view

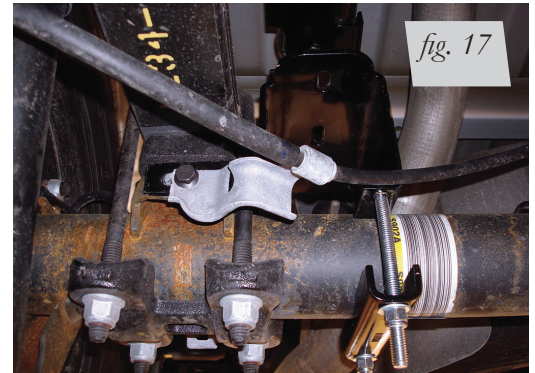

Passenger-side front view

Two-wheel drive models with lower bracket installed:

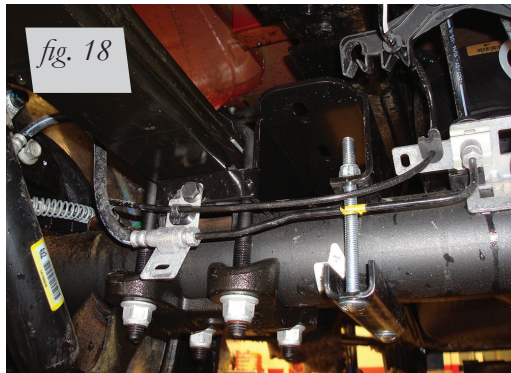

Driver-side rear view

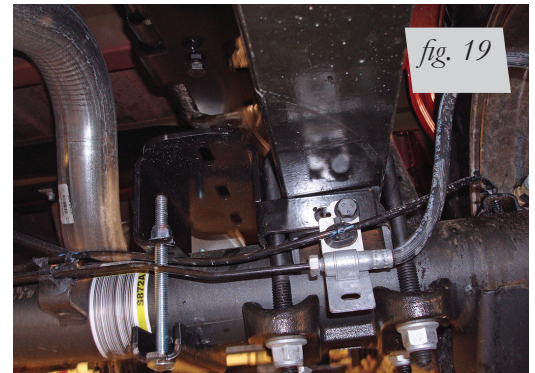

Passenger-side rear view

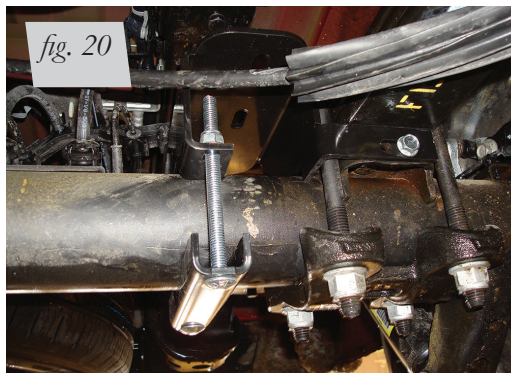

Driver-side front view

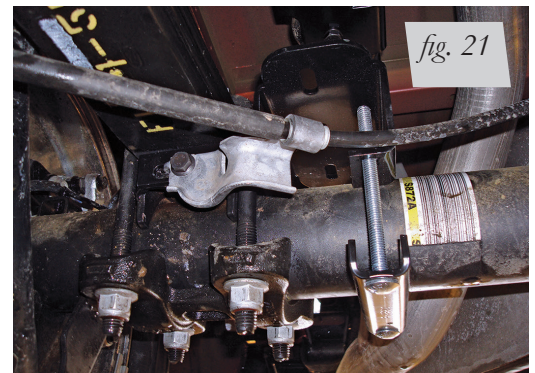

Passenger-side front view

ASSEMBLING THE AIR SPRINGS ASSEMBLIES

1. Set a roll plate (H) over the air spring (G).

NOTE

The radiused (rounded) edge of the roll plate (H) will be towards the air spring, so that the air spring is seated inside both roll plates.

2. Install the swivel fitting (I) into the top of the air spring finger-tight plus one-and-a-half turns (Fig. 22). Repeat for both air springs.

fig. 22

3. Set the upper air spring bracket (D) onto the air spring so that the slot is on the fitting side (it will only bolt on one way) and attach with two 3/8" screws (J), two lock washers (K) and two flat washers (L) (Fig. 23). Torque the mounting hardware to no more than 20 lb.-ft. Repeat for the opposite side. Figure 24 shows the left- and right-hand assemblies.

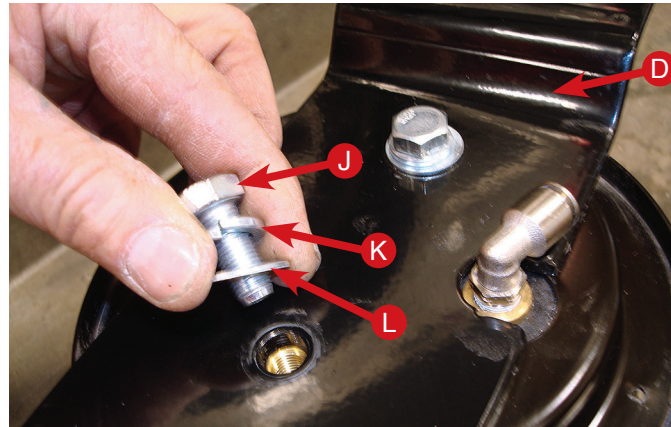
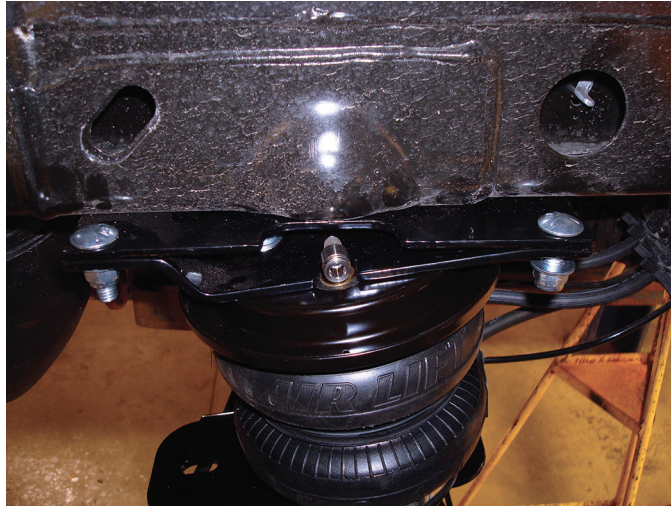

fig. 23

fig. 24

INSTALLING THE AIR SPRING ASSEMBLIES

1. With the axle dropped low enough to put the assemblies into position, set the left- and right-hand assemblies on the lower brackets (previously installed), making sure that the fittings are on the outside of the frame as shown. Lift and attach the air spring upper bracket to the frame bracket using two 3/8" carriage bolts (O), two flat washers (L) and two nylon lock nuts (R) (Figs. 25, 26). Torque hardware to 20 lb.-ft. Repeat for the opposite side.



Driver-side (left) assembly shown.
NOTE: Fitting goes on the outside of the frame.

fig. 25

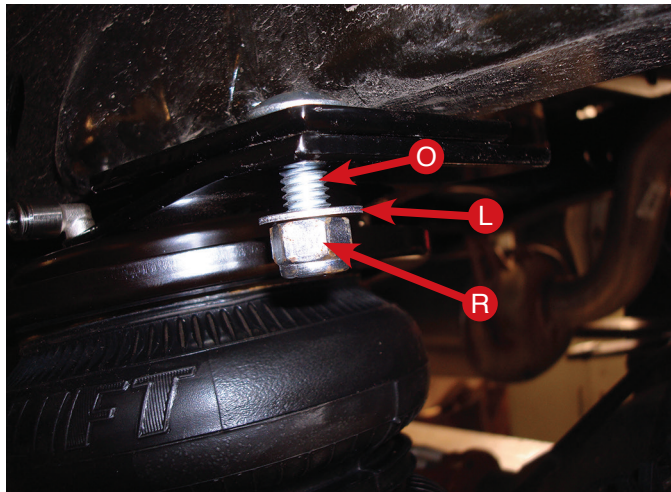

fig. 26

2. Set a roll plate in between the bellows and the lower bracket. Align the holes in the lower bracket and roll plate to the threaded inserts in the air spring (Fig. 27).



Slide the roll plate between the lower bracket and air spring while aligning the holes in all three.

fig. 27

3. Raise the suspension back up just enough so that the air spring comes in contact with the roll plate and the lower bracket. Align the holes again and attach the lower air spring to the lower bracket using two 3/8" bolts (J), two lock washers (K) and flat washer (L) (Fig. 28). Repeat for the opposite side.
4. Raise the axle all the way up and adjust the air spring by pushing it forward in the slot. Make sure it is aligned so that it is perpendicular to the upper and lower bracket. Torque the lower mounting bolts to no more than 20 lb.-ft.

fig. 28

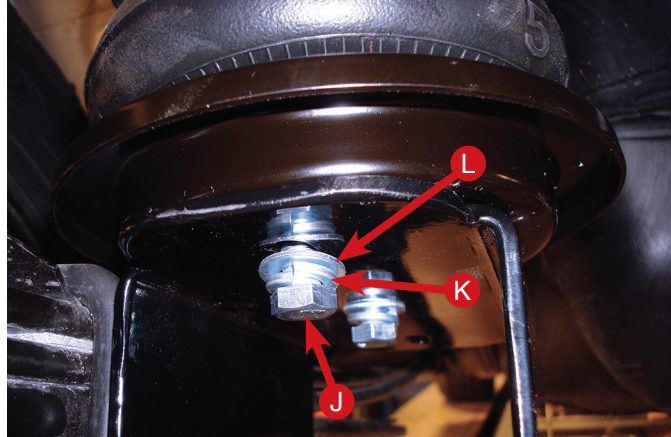

Align the holes in the lower bracket and roll plate to the threaded insert in the air spring and attach with (L), (K) and (J).

5. Remove the jack stands.
6. Figures 29, 30 and 31 show the finished installation of both left- and right-hand assemblies (four wheel models shown).

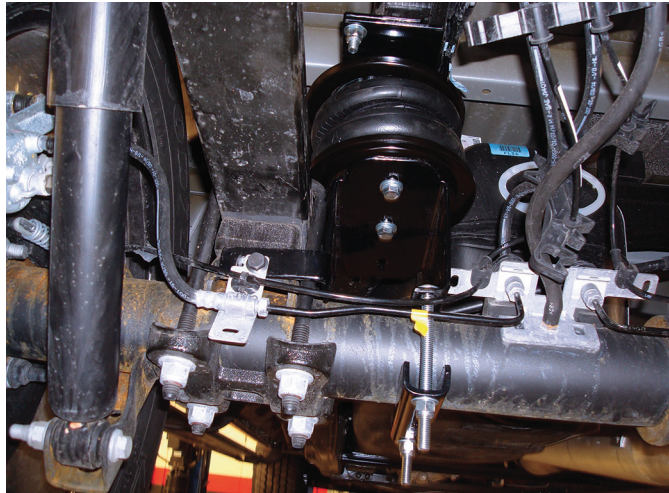

Back view of left-side mounted assembly

fig. 29

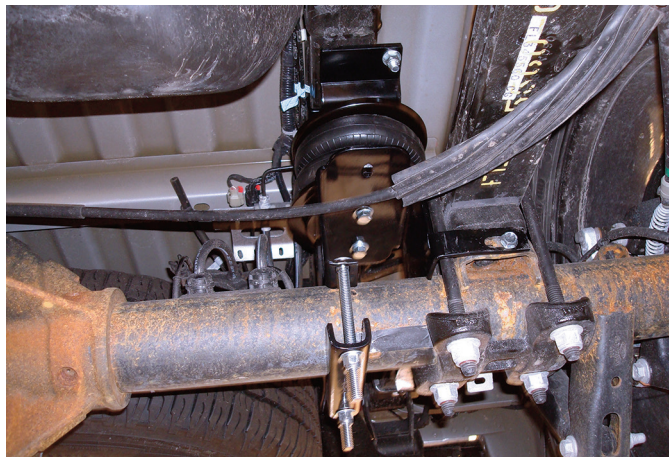

Front view of left-side mounted assembly

fig. 30



Inside view of right-side mounted assembly

fig. 31

FINISHING THE INSTALLATION

For 2WD models it will be necessary to trim the Brake/ABS line holder that is closest to the axle so that it does not chafe on the driver side bellows.

1. Trim the outboard open slot on the plastic line holder off using a hack saw or side cutters (Fig. 32). Finished photo shown in Figure 33.

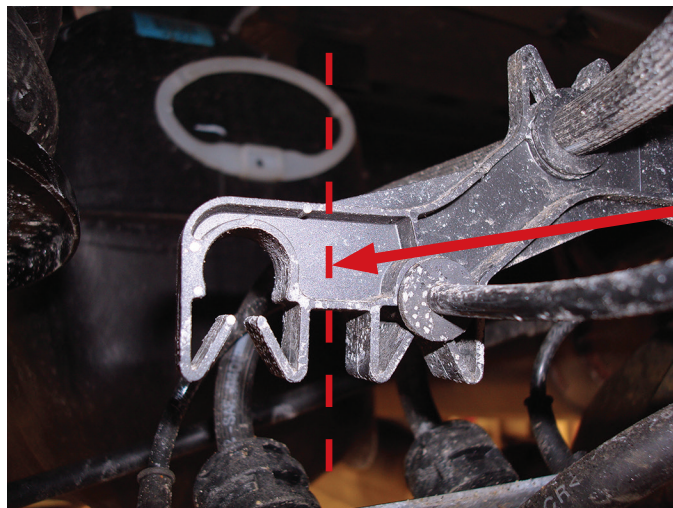

Trim Brake/ABS line holder off here.

fig. 32



fig. 33

INSTALLING THE AIR LINES

1. Ford prefers not to have any non-aluminum component be attached to the body of this truck. It will be necessary to find a steel mounting location for the inflation valve, such as:
 - a. the license plate recess in bumper,
 - b. under the bumper,
 - c. bumper mounting brackets.

NOTE

What ever the chosen location is, make sure there is enough clearance around the inflation valves for an air chuck.

2. Drill a 5/16" hole to install the inflation valves.
3. Cut the air line assembly (AA) in two equal lengths.

CAUTION

WHEN CUTTING OR TRIMMING THE AIR LINE, USE A HOSE CUTTER, A RAZOR BLADE OR A SHARP KNIFE. A CLEAN, SQUARE CUT WILL PREVENT LEAKS. DO NOT USE WIRE CUTTERS OR SCISSORS TO CUT THE AIR LINE. THESE TOOLS MAY FLATTEN OR CRIMP THE AIR LINE, CAUSING IT TO LEAK AROUND THE O-RING SEAL INSIDE THE ELBOW FITTING (FIG. 34)

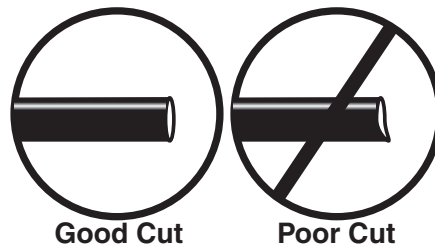

fig. 34

4. Place a 5/16" nut (GG) and a star washer (FF) on the air valve. Leave enough of the inflation valve in front of the nut to extend through the hole and have room for the rubber washer (EE), flat washer (DD), and 5/16" nut (GG) and cap (CC). There should be enough valve exposed after installation - approximately 1/2" - to easily apply a pressure gauge or an air chuck (Fig. 35).
5. Push the inflation valve through the hole and use the rubber washer (EE), flat washer (DD), and another 5/16" nut (GG). Tighten the nuts to secure the assembly in place (Fig. 35).

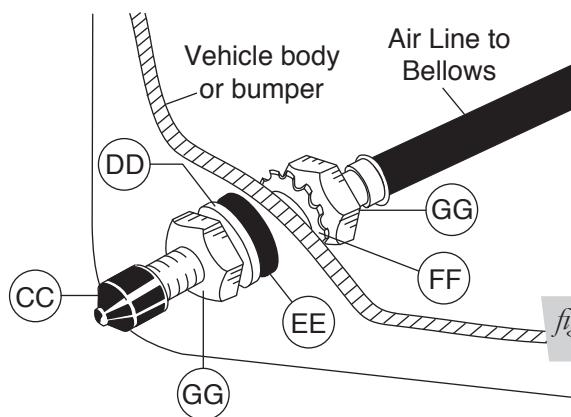
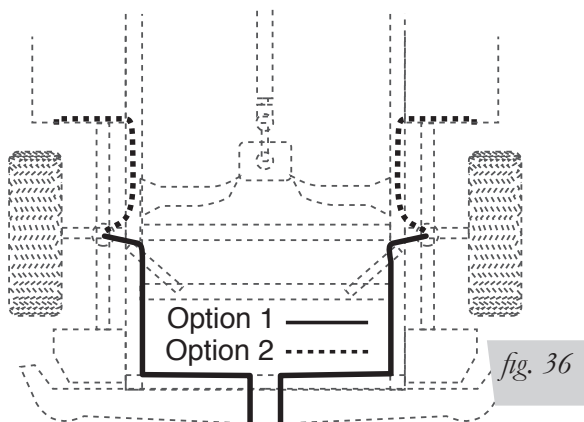

fig. 35

6. Route the air line along the frame to the air fitting on the air spring (Fig. 36). Keep AT LEAST 6" of clearance between the air line and heat sources, such as the exhaust pipes, muffler, or catalytic converter. Avoid sharp bends and edges. Use the plastic tie straps (BB) to secure the air line to fixed, non-moving points along the chassis. Be sure that the tie straps are tight, but do not pinch the air line. Leave at least 2" of slack to allow for any movement that might pull on the air line.



7. Cut off the air line leaving approximately 12" of extra air line. A clean square cut will prevent leaks (see Fig. 27). Insert the air line into the air fitting. This is a push to connect fitting. Simply push the air line into the 90° swivel fitting until it bottoms out (9/16" of air line should be in the fitting).

CHECKING FOR LEAKS

1. Inflate the air spring to 30 PSI and spray all connections and the inflation valves with a solution of 1/5 liquid dish soap and 4/5 water to check for leaks. Spot leaks easily by looking for bubbles in the soapy water.
2. After the test, deflate the springs to the minimum pressure required to restore the normal ride height, no less than 5 PSI.
3. Check the air pressure again after 24 hours. A 2-4 PSI loss after initial installation is normal. Retest for leaks if the loss is more than 5 lbs.

FIXING LEAKS

1. If there is a problem with the swivel fitting:
 - a. Check the air line connection by deflating the spring and removing the line by pulling the collar against the fitting and pulling firmly on the air line. Trim 1" off the end of the air line. Be sure the cut is clean and square (see Fig. 34). Reinsert the air line into the push-to-connect fitting.
 - b. Check the threaded connection by tightening the swivel fitting another 1/2 turn. If it still leaks, deflate the air spring, remove the fitting, and re-coat the threads with thread sealant. Reinstall by hand tightening as much as possible, then use a wrench for an additional two turns.
2. If there is a problem with the inflation valve, then:
 - a. Check the valve core by tightening it with a valve core tool.
 - b. Check the air line connection by removing the air line from the barbed type fitting.



DO NOT CUT THE AIR LINE COMPLETELY OFF AS THIS WILL NICK THE BARB AND RENDER THE FITTING USELESS.

3. If the preceding steps have not resolved the problem, call Air Lift customer service at (800) 248-0892 for assistance.

Before Operating

INSTALLATION CHECKLIST (To be completed by installer)

- Clearance test — Inflate the air springs to 60 PSI and ensure there is at least 1/2" clearance around each bellow, away from anything that might rub against them. Be sure to check the tire, brake drum, frame, shock absorbers and brake cables.
- Leak test before road test — Inflate the air springs to 60 PSI, check all connections for leaks with a soapy water solution. See the *Checking for Leaks* section for tips on how to spot leaks. All leaks must be eliminated before the vehicle is road tested.
- Heat test — Be sure there is sufficient clearance from any heat sources — at least 6" for air springs and air lines. If a heat shield was included in the kit, install it. If there is no heat shield, but one is required, call (800) 248-0892.
- Fastener test — Recheck all bolts for proper torque. Retorque after 100 miles.
- Road test — The vehicle should be road tested after the preceding tests. Inflate the air springs to 25 PSI (50 PSI if the vehicle is loaded). Drive the vehicle 10 miles and recheck for clearance, loose fasteners and air leaks.
- Operating instructions — If professionally installed, the installer should review the *Product Use, Maintenance and Servicing* section with the owner. Be sure to provide the owner with all of the paperwork which came with the kit.

Technician's Signature _____

Date _____

POST-INSTALLATION CHECKLIST

- Overnight leak down test — Recheck air pressure after the vehicle has been used for 24 hours. If the pressure has dropped more than 5 PSI, then there is a leak that must be fixed. Either fix the leak yourself or return to the installer for service.
- Air pressure requirements — Regardless of load, the air pressure should always be adjusted to maintain ride height at all times.
- Thirty day or 500 mile test — Recheck the air spring system after 30 days or 500 miles, whichever comes first. If any part shows signs of rubbing or abrasion, the source should be identified and moved, if possible. If it is not possible to relocate the cause of the abrasion, the air spring may need to be remounted. If professionally installed, the installer should be consulted. Check all fasteners for tightness.

Product Use, Maintenance and Servicing

Minimum Recommended Pressure	Maximum Air Pressure
5 PSI	100 PSI

MAINTENANCE GUIDELINES

NOTE

By following the steps below, vehicle owners will obtain the longest life and best results from their air springs.

1. Check the air pressure weekly.
2. Always maintain normal ride height. Never inflate beyond 100 PSI.
3. If you develop an air leak in the system, use a soapy water solution (1/5 liquid dish soap and 4/5 water) to check all air line connections and the inflation valve core before deflating and removing the air spring.

CAUTION

FOR YOUR SAFETY AND TO PREVENT POSSIBLE DAMAGE TO YOUR VEHICLE, DO NOT EXCEED MAXIMUM GROSS VEHICLE WEIGHT RATING (GVWR), AS INDICATED BY THE VEHICLE MANUFACTURER. ALTHOUGH YOUR AIR SPRINGS ARE RATED AT A MAXIMUM INFLATION PRESSURE OF 100 P.S.I., THE AIR PRESSURE ACTUALLY NEEDED IS DEPENDANT ON YOUR LOAD AND GVWR.

4. Loaded vehicles require at least 25 PSI or more. A “loaded vehicle” refers to a vehicle with a heavy bed load, a trailer, or both. As discussed above, never exceed GVWR, regardless of air spring, air pressure, or other load assist. The springs in this kit will support approximately 40 lbs. of load (combined on both springs) for each 1 PSI of pressure. The required air pressure will vary depending on the state of the original suspension. Operating the vehicle below the minimum air spring pressure will void the Air Lift warranty.
5. When increasing load, always adjust the air pressure to maintain the normal ride height. Increase or decrease pressure from the system as necessary to attain normal ride height for optimal ride and handling. Remember that loads carried behind the axle (including tongue loads) require more leveling force (pressure) than those carried directly over the axle.
6. Always add air to springs in small quantities, checking the pressure frequently.
7. Should it become necessary to raise the vehicle by the frame, make sure the system is at minimum pressure (5 PSI) to reduce the tension on the suspension/brake components. Use of on board leveling systems do not require deflation or disconnection.
8. Periodically check the air spring system fasteners for tightness. Also, check the air springs for any signs of rubbing. Realign if necessary.
9. On occasion, give the air springs a hard spray with a garden hose in order to remove mud, sand, gravel or other abrasive debris.

TROUBLESHOOTING GUIDE

1. Leak test the air line connections, the threaded connection into the air spring, and all fittings in the control system.
2. Inspect the air lines to be sure none are pinched. Tie straps may be too tight. Loosen or replace the strap and replace leaking components.
3. Inspect the air line for holes and cracks. Replace as needed.
4. Look for a kink or fold in the air line. Reroute as needed.

If the preceding steps do not solve the problem, it is possibly caused by a failed air spring — either a factory defect or an operating problem. Please call Air Lift at (800) 248-0892 for assistance.

FREQUENTLY ASKED QUESTIONS

Q. Will installing air springs increase the weight ratings of a vehicle?

No. Adding air springs will not change the weight ratings (GAWR, GCWR and/or GVWR) of a vehicle. Exceeding the GVWR is dangerous and voids the Air Lift warranty.

Q. Is it necessary to keep air in the air springs at all times and how much pressure will they need?

For LoadLifter 5000 Ultimate, the recommended minimum air pressure is 5 PSI, but it can safely be run at zero air pressure.

Q. Is it necessary to add a compressor system to the air springs?

No. Air pressure can be adjusted with any type of compressor as long as it can produce sufficient pressure to service the springs. Even a bicycle tire pump can be used, but it's a lot of work.

Q. How long should air springs last?

If the air springs are properly installed and maintained they can last indefinitely.

Q. Will raising the vehicle on a hoist for service work damage the air springs?

No. The vehicle can be lifted on a hoist for short-term service work such as tire rotation or oil changes. However, if the vehicle will be on the hoist for a prolonged period of time, support the axle with jack stands in order to take the tension off of the air springs.

TUNING THE AIR PRESSURE

Pressure determination comes down to three things — level vehicle, ride comfort, and stability.

1. Level vehicle

If the vehicle's headlights are shining into the trees or the vehicle is leaning to one side, then it is not level (Fig. 2.1). Raise the air pressure to correct either of these problems and level the vehicle.

2. Ride comfort

If the vehicle has a rough or harsh ride it may be due to either too much pressure or not enough (Fig. 2.2). Try different pressures to determine the best ride comfort.

3. Stability

Stability translates into safety and should be the priority, meaning the driver may need to sacrifice a perfectly level and comfortable ride. Stability issues include roll control, bounce, dive during braking and sponginess (Fig. 2.3). Tuning out these problems usually requires an increase in pressure.

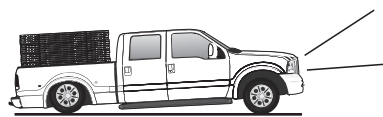

Bad headlight aim *fig. 2.1*



Rough ride *fig. 2.2*

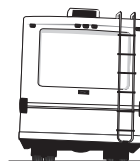

Sway and body roll *fig. 2.3*

GUIDELINES FOR ADDING AIR

1. Start with the vehicle level or slightly above.
2. When in doubt, always add air.
3. If the front of the vehicle dives while braking, increase the pressure in the front air bags, if equipped.
4. If it is ever suspected that the air bags have bottomed out, increase the pressure (Fig. 2.4).
5. Adjust the pressure up and down to find the best ride.
6. If the vehicle rocks and rolls, adjust the air pressure to reduce movement.
7. It may be necessary to maintain different pressures on each side of the vehicle. Loads such as water, fuel, and appliances will cause the vehicle to be heavier on one side (Fig. 2.5). As much as a 50 PSI difference is not uncommon.

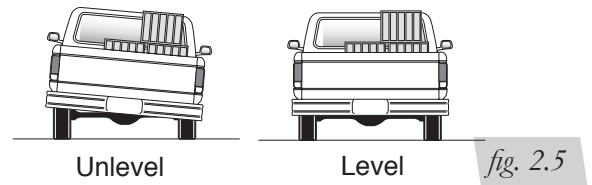



Limited Warranty and Return Policy

WHAT THIS WARRANTY COVERS

Air Lift Company provides a warranty to the original purchaser of its Load Support Products, for the periods of time listed below, by product line, from the date of original purchase, that the products will be free from defects in workmanship and materials when used on cars and trucks as specified by Air Lift Company and under normal operating conditions, subject to the requirements and exclusions set forth below.

WHAT THIS WARRANTY DOES NOT COVER

The warranty does not apply to products that have been improperly applied, improperly installed, or which have not been maintained in accordance with installation instructions furnished with all products. This warranty does not apply and is void if damage or failure is caused by: accident, abuse, misuse (including but not limited to racing or off-road activities or commercial use), abnormal use, faulty installation, liquid contact, fire, earthquake or other external cause; operating the product outside Air Lift Company’s instructions, specifications or guidelines; or service, alteration, maintenance or repairs performed by anyone other than Air Lift Company to the product from its purchased condition. This warranty also does not apply to: consumable parts, such as batteries; cosmetic damage, including but not limited to scratches or dents; defects caused by normal wear and tear or otherwise due to the normal aging of the product, or if any serial or identification number has been removed or defaced from the product. Air Lift Company reserves the right to change the design of any product without assuming any obligation to modify any product previously manufactured.

LIMITATION OF LIABILITY

To the extent permitted by law, this warranty and the remedies set forth herein are exclusive and in lieu of all other warranties, remedies and conditions, whether oral, written, statutory, express or implied. AIR LIFT COMPANY DISCLAIMS ALL STATUTORY AND IMPLIED WARRANTIES, INCLUDING WITHOUT LIMITATION, WARRANTIES OF MERCHANTABILITY AND FITNESS FOR A PARTICULAR PURPOSE AND WARRANTIES AGAINST HIDDEN OR LATENT DEFECTS TO THE EXTENT PERMITTED BY LAW. To the extent such warranties cannot be disclaimed, such implied warranties shall apply only for the warranty period specified above. Please note that some states do not allow limitation on how long an implied warranty (or condition) lasts. So the above limitation may not apply to you.

Except as provided in this warranty and to the extent permitted by law, Air Lift Company shall not be liable for any direct, special, incidental or consequential damages resulting from any breach of warranty or condition, or arising in connection with the sale, use or repair of air lift products, or under any other legal theory, including but not limited to loss of use, loss of revenue, loss of actual or anticipated profits, loss of the use of money, loss of business, loss of opportunity, loss of goodwill, and loss of reputation. Air Lift Company’s maximum liability shall not in any case exceed the purchase price paid by you for the Air Lift product. Please note that some states do not allow the exclusion or limitation of incidental or consequential damages, so the above limitation or exclusion may not apply to you.

HOW TO GET SERVICE

If a defect in workmanship or materials causes your Air Lift product to become inoperable within the warranty period, before returning any defective product, call Air Lift Company at (800) 248-0892 in the U.S. and Canada (elsewhere, (517) 322-2144) to obtain a Returned Materials Authorization (RMA) number. The consumer shall be responsible for removing (labor charges) the defective product from the vehicle and returning it, shipping costs prepaid, to Air Lift Company for verification. Returns to Air Lift Company must be postage prepaid and sent to: Air Lift Company • 2727 Snow Road • Lansing, MI • 48917. You must prove to the satisfaction of Air Lift Company the date of original purchase of your Air Lift product. You must also enclose the RMA number and a return address. A minimum \$10 shipping and handling charge will apply to all warranty claims. You must also pack the product to minimize the risk of it being damaged in transit. If we receive a product in damaged condition as the result of shipping, we will notify you and you must seek a claim with the shipper.

WHAT AIR LIFT COMPANY WILL DO

If you submit a valid claim to Air Lift Company during the warranty period, Air Lift Company will, at its option, repair your Air Lift product or furnish you with a new or rebuilt product. Air Lift Company will not reimburse you for repairs or replacement parts provided by other parties. Your repaired or replacement Air Lift product will be returned to you (subject to payment of the required warranty claim shipping and handling charge) and it will be covered under the warranty for the balance of the warranty period, if any. When a product or part is replaced, any replacement item becomes your property and the replaced item becomes property of Air Lift Company. You are responsible for installation/reinstallation (labor charges) of the product.

HOW THE LAW RELATES TO THIS WARRANTY

This warranty gives you specific legal rights and you may also have other rights which vary from state to state. By this warranty, Air Lift Company does not limit or exclude your rights except as allowed by law. To fully understand your rights, you should consult the laws of your state.

SPECIFIC LOAD SUPPORT WARRANTY PERIODS BY PRODUCT LINE

LoadLifter 5000™ Ultimate.....	Lifetime Limited	WirelessAIR™.....	2 Year Limited
LoadLifter 5000™.....	Lifetime Limited	WirelessONE™.....	2 Year Limited
RideControl™.....	Lifetime Limited	LoadController™ Single and Dual.....	2 Year Limited
Air Lift 1000™.....	Lifetime Limited	LoadController™ I and II.....	2 Year Limited
AirCell™.....	Lifetime Limited	SmartAir™ II.....	2 Year Limited
SlamAir™.....	Lifetime Limited	Other Accessories.....	2 Year Limited

Replacement Information

If you need replacement parts, contact the local dealer or call Air Lift customer service at (800) 248-0892. Most parts are immediately available and can be shipped the same day.

Contact Air Lift Company customer service at (800) 248-0892, first if:

- Parts are missing from the kit.
- Need technical assistance on installation or operation.
- Broken or defective parts in the kit.
- Wrong parts in the kit.
- Have a warranty claim or question.

Contact the retailer where the kit was purchased:

- If it is necessary to return or exchange the kit for any reason.
- If there is a problem with shipping if shipped from the retailer.
- If there is a problem with the price.

Contact Information

If you have any questions, comments or need technical assistance, contact our customer service department by calling (800) 248-0892, Monday through Friday. For calls from outside the USA or Canada, our local number is (517) 322-2144.

For inquiries by mail, our address is PO Box 80167, Lansing, MI 48908-0167. Our shipping address for returns is 2727 Snow Road, Lansing, MI 48917.

You may also contact us anytime by e-mail at sales@airliftcompany.com or on the web at www.airliftcompany.com.

Need Help?

Contact our customer service department by calling (800) 248-0892, Monday through Friday. For calls from outside the USA or Canada, our local number is (517) 322-2144.

**Register your warranty online at
www.airliftcompany.com/warranty**



Thank you for purchasing Air Lift products — the professional installer's choice!

Air Lift Company • 2727 Snow Road • Lansing, MI 48917 or PO Box 80167 • Lansing, MI 48908-0167
Toll Free (800) 248-0892 • Local (517) 322-2144 • Fax (517) 322-0240 • www.airliftcompany.com

Printed in the USA
JJC-0816