

# CS/CTS

## USER GUIDE



**CTS**  
COLOR TOUCH SCREEN



**CS**  
COLOR SCREEN

**\*\*READ IMPORTANT SAFETY INFORMATION IN THIS MANUAL\*\***

**JUICE**  
*ATTITUDE*

**EVOLUTION**

**INSIGHT**

**EDGE**  
PRODUCTS

# TABLE OF CONTENTS

TABLE OF CONTENTS

INTRODUCTION

PARTS DESCRIPTION

OPERATING INSTRUCTIONS

INTERNET UPDATES

APPENDIX

**INTRODUCTION..... 4**

- SAFETY WARNING & CAUTION..... 4*
- SAFETY GUIDELINES..... 5*
- LIMITED 1 YEAR WARRANTY ..... 6*
- WARRANTY INFORMATION ..... 7*
- CARB/EPA COMPLIANCE ..... 9*
- PRODUCT REGISTRATION.....10*
- PRODUCT INFORMATION .....10*
- USING THE MANUAL.....12*
- PARTS INCLUDED.....13*

**PARTS DESCRIPTION ..... 13**

**OPERATING INSTRUCTIONS ..... 16**

- CS GAUGE SCREEN LAYOUT .....16*
- CTS GAUGE SCREEN LAYOUT.....17*
- GAUGE DISPLAY INFORMATION .....18*
- GAUGE LAYOUT OPTIONS..... 18*

  - SELECT NEW PID..... 18*
  - ALERT SETTINGS..... 18*
  - GAUGE COLOR..... 18*
  - PID INFORMATION..... 18*
  - EXIT MENU ..... 18*

**NAVIGATING THE MAIN MENU ..... 19**

- MENU BUTTONS..... 19*
- VIEW CAMERA (CTS)..... 19*
- SHOW ALERTS ..... 20*
- SHOW MAINTENANCE DUE..... 21*
- DIAGNOSTICS..... 21*

  - TROUBLE CODES ..... 21*
  - MANUAL DPF REGENERATION..... 22*
  - TRANSMISSION RELEARN ..... 24*
  - PERFORMANCE TESTS ..... 24*
  - RECORDS ..... 25*
  - INJECTOR BALANCE RATES..... 25*

**MAINTENANCE MANAGER..... 26**

**OPTIONS MENU ..... 28**

- ALERT OPTIONS (SETTINGS)..... 28*
- SOUND DURATION ..... 29*
- SCREEN LAYOUT..... 29*
- BACKLIGHT AUTODIM ..... 30*
- MENU TIMEOUT..... 30*
- TIRE SIZE..... 30*

ACCESSORY OPTIONS .....	31
UNITS.....	32
FACTORY RESET .....	33
HELP MENU.....	33
PRODUCT INFO -CS/CTS.....	33
PRODUCT INFO - EAS.....	33
VEHICLE INFO .....	34
CONTACT INFO .....	34
TECH SUPPORT TOOLS .....	34
<b>EVOLUTION .....</b>	<b>35</b>
PROGRAMMING.....	35
USING LEVELS .....	35
CUSTOM OPTIONS .....	35
POWER LEVELS.....	37
RACE EVOLUTION.....	38
<b>ATTITUDE.....</b>	<b>38</b>
POWER LEVELS.....	38
JUICE CONTROL .....	39
HOT UNLOCKER.....	40
RACE ATTITUDE.....	41
DPF OPTIONS .....	41
PROGRAMMING.....	41
<b>INSIGHT.....</b>	<b>42</b>
EFI LIVE™ .....	42
<b>USING ACCESSORIES.....</b>	<b>43</b>
EAS.....	43
JAB (EAS) .....	43
EGT PROBE (EAS).....	43
EGT PROBE [STANDARD].....	43
EDGE BACKUP CAMERA .....	44
EDGE MOUNTING SOLUTIONS.....	44
<b>CUSTOMIZATION.....</b>	<b>46</b>
BACK GROUND IMAGE .....	46
USING MYSTYLE .....	46
<b>INTERNET UPDATES.....</b>	<b>47</b>
FUSION UPDATE SOFTWARE.....	47
USING THE SOFTWARE.....	47
PROGRAMMING ERRORS.....	49
UPDATE REQUIRED .....	49
NON-STOCK CONDITION .....	49
<b>APPENDIX.....</b>	<b>49</b>
DEM EGT LOCATIONS.....	50
TIPS/TROUBLE SHOOTING .....	53
COMMONLY USED ACRONYMS .....	55
INDEX .....	56

TABLE OF CONTENTS

INTRODUCTION

PARTS DESCRIPTION

OPERATING INSTRUCTIONS

INTERNET UPDATES

APPENDIX

## SAFETY WARNING &amp; CAUTION

## SAFETY TERMS

Throughout this User Guide (hereafter noted as User Manual or Manual) you will see important messages regarding your safety or the protection of your vehicle. These messages are designated by the words WARNING or CAUTION.



**WARNING** indicates a condition that may cause serious injury or death to you, your passengers or others nearby. Pay careful attention to these Warning messages, and always comply with them. They could save a life.

**CAUTION** indicates a condition that could cause damage to your vehicle. It is important to install and operate your EDGE product in conformance with instructions in this Manual. Caution alerts you to particularly important things that will keep your vehicle operating properly.

The Edge Product you have bought is a high-performance product. As such, it does present some risks of which you should be fully aware. Do not use this product until you have carefully read the following safety information and the Owner Agreement.

**NOTE:** After the device has been installed, the screen and logo will appear followed by a warning and compliance directive. To indicate you accept and acknowledge the warning and compliance, press the [ENTER] or [YES] button.

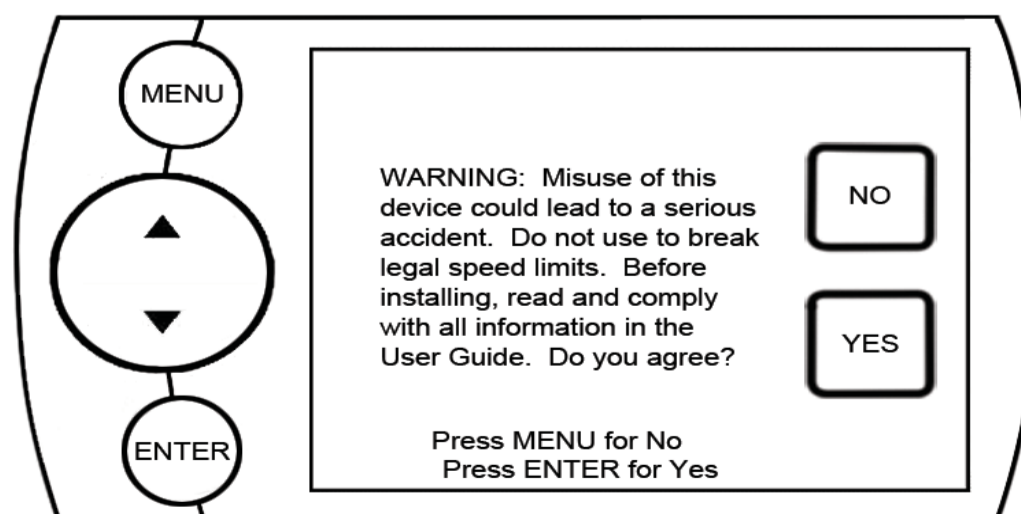



## SAFETY GUIDELINES

### SAFETY GUIDELINES

1. Do not exceed legal speed limits on public roadways. Use any enhanced speed capabilities of this product only in closed circuit, legally sanctioned racing environments expressly for this purpose. Loss of control from speeding on a public road could seriously injure you, your passengers, or others on the roadway.
2. Do not operate the device while driving. Perform all adjustments or changes while stopped. Changing a setting while under way can interfere with your attention to roadway conditions.
3. “Stacking” performance-enhancing devices or other improper installation can cause power train failure on the road. Other products may have features incompatible with your Edge device. Follow all installation and operating instructions, and do not stack products.
4. Some modifications may affect other parts of your vehicle. For example, if you remove/adjust the speed limiter in your vehicle, be sure your tires and other components are rated for the increased speeds they will have to withstand. Not doing so can lead to loss of vehicle control. Modify the speed limiter only for use in closed circuit, legally sanctioned racing environments, not for use on public roadways.

***NOTE: Dispose of this product consistent with local codes. Return to your electronics supplier for proper handling.***



#### **WARNING**

***Misapplication or misuse of this product could lead to a serious or fatal accident. Comply with all safety information in this manual, and your vehicle owner’s manual. Follow safety, installation and operating instructions in this User Manual to assure proper use.***

**LIMITED 1 YEAR WARRANTY*****LIMITED 1 YEAR WARRANTY***

Edge Products, LLC, (hereafter “SELLER”) gives Limited Warranty as to description, quality, merchantability, fitness for any product’s purpose, productiveness, or any other matter of SELLER’s product sold herewith. The SELLER shall be in no way responsible for the product’s open use and service and the BUYER hereby waives all rights other than those expressly written herein. This Warranty shall not be extended or varied except by a written instrument signed by SELLER and BUYER.

The Warranty is Limited to one (1) year from the date of sale and limited solely to the parts contained within the product’s kit. All products that are in question of Warranty must be returned shipping prepaid to the SELLER and must be accompanied by a dated proof of purchase receipt. All Warranty claims are subject to approval by Edge Products Inc.

Under no circumstances shall the SELLER be liable for any labor charged or travel time incurred in diagnosis for defects, removal, or reinstallation of this product, or any other contingent expenses.

If the BUYER sends back a failed unit that is out of warranty and chooses to buy a refurbished unit, the refurbished unit will only carry a 90 day warranty. If the BUYER purchases a new unit at a predetermined discounted rate, it will have the standard 1 year warranty.

Under no circumstances will the SELLER be liable for any damage or expenses insured by reason of the use or sale of any such equipment.

**THE INSTALLATION OF THIS PRODUCT INDICATES THAT THE BUYER HAS READ AND UNDERSTANDS THIS AGREEMENT AND ACCEPTS ITS TERMS AND CONDITIONS.**

**IN THE EVENT THAT THE BUYER DOES NOT AGREE WITH THIS AGREEMENT, THE BUYER MAY PROMPTLY RETURN THIS PRODUCT, IN A NEW AND UNUSED CONDITION, WITH A DATED PROOF OF PURCHASE, TO THE PLACE OF PURCHASE WITHIN THIRTY (30) DAYS FROM DATE OF PURCHASE FOR A FULL REFUND.**

***NOTE: This warranty is void for any new products purchased through auction web sites. Warranty is valid only for new products purchased through Authorized Dealers (proof of purchase required for all warranty claims).***

**WARRANTY INFORMATION**

**IMPORTANT INFORMATION ABOUT YOUR VEHICLE'S WARRANTY**

Many of our customers ask, “Will your product void my vehicle’s manufacturer’s warranty?” While the answer is straightforward from a legal standpoint, it’s important to educate our customers (and all aftermarket consumers) on some industry realities and offer some common sense precautions to minimize your risk. Edge is committed to providing quality products that are safe to use. Our products do not cause damage to a vehicle when used as intended.

***CAUTION: Operate your vehicle within manufactures recommended load and weight limits as shown in the Manufactures Operator Manual. Please keep in mind that towing in anything higher than the towing level and hard driving in race or extreme performance levels using Edge products is not recommended.***

Consumers of aftermarket products are protected by the Federal Magnusson-Moss Warranty Act. The Act states that if something breaks on your vehicle and you take it in for warranty repair, the dealer must honor your warranty unless whatever modifications you have added to your vehicle actually caused the problem in question.

However, the reality is that many dealerships have been known to void warranties on vehicles that use aftermarket products as a matter of policy. This applies in particular to those aftermarket products that produce horsepower, such as performance enhancement “chips,” modified intake manifolds, or aftermarket exhaust systems, regardless of product brand.

You have strong legal protection as a consumer in regard to your vehicle’s warranty. However, Edge strongly recommends you always disconnect and remove your module/programmer and monitor when you take your vehicle to a dealer for warranty work. In addition, leaving the product connected may affect dealer diagnostic analysis and scan tool functions. Edge makes every effort to produce product that can be easily removed.

***NOTE: Even if you disconnect your unit, your dealer can detect the use of any programmer—even if the unit has been removed.***

Thank you for purchasing the Edge CS/CTS products. The CS and CTS products have been developed and produced from the highest quality materials available to ensure the best performance for years to come. If you have any concerns or questions, please contact us.



SERVICE CENTER AND COMPATIBILITY CAUTIONS

CAUTION: RETURN YOUR VEHICLE TO STOCK BEFORE TAKING IT TO A SERVICE CENTER. All Edge modules and programmers are built to operate with OEM calibrations. If you take your vehicle to a service center they may, by your request or otherwise, update your vehicle’s calibrations. If this happens and your vehicle has not been returned to stock your device will no longer be capable of programming your vehicle. Therefore it is important that you return your vehicle to stock before taking it in for service. Edge updates its active products (i.e. those currently being manufactured) to work effectively with updated OEM calibrations. However, this process can take some time as Edge is not always made aware of calibration changes made by the OEM. In the case of discontinued products, Edge cannot ensure that your unit will work effectively if you take your vehicle to a dealership and you are given, by your request or otherwise, a new calibration.

***CAUTION: If you have used another tuner/programmer on your vehicle, you will need to program the vehicle back to stock and remove the device before using the Edge Product. Failure to return to stock may result in PCM failure or engine damage. Programming your vehicle may expose existing defects in the vehicle’s PCM that could disable your vehicle. It is advised that you do not program your vehicle in remote locations in case of vehicle failure.***

***CAUTION: The Evolution programmer was developed on a stock vehicle with no aftermarket bolt-on parts; as such, the performance changes implemented by the Evolution may not be compatible with certain aftermarket power add-ons. See below for a brief explanation of how the Evolution tuning may be affected by certain aftermarket devices.***

COLD AIR INTAKE (CAI) KITS

Most modern-day vehicles use a Mass Air Flow (MAF) sensor. The MAF sensor is generally located in the intake tube close to the factory air box. MAF sensors play a key role in determining the amount of fuel an engine needs at any given throttle position. MAF sensors are precisely calibrated for the factory intake systems; changes in intake tube diameter, sensor placement, or filter flow characteristics can adversely affect the reading from the MAF sensor. Most of the CAI kits on the market change intake tube diameter, sensor placement, or filter restriction. These changes may cause the sensor to command leaner fuel conditions. Most of the CAI kits on the market are developed on stock vehicles, where a leaner fuel curve may be acceptable. Due to the fact that the evolution already alters the vehicle’s fueling strategies, CAI kits that create a leaner condition used in conjunction with the Evolution may cause the vehicle to run excessively lean. Excessively lean conditions can cause pre-ignition which can lead to detonation, a condition that could potentially damage an engine.

TABLE OF CONTENTS

INTRODUCTION

PARTS DESCRIPTION

OPERATING INSTRUCTIONS

INTERNET UPDATES

APPENDIX



There are currently a large number of CAI kits on the market. These kits are designed to improve air flow and temperature. Some of these kits may be compatible with the Evolution programmer; however others may cause a lean condition when used in conjunction with the Evolution tuning. If you use the Evolution in conjunction with a CAI kit on E/F Series 1997 and newer (especially on a 2004 or newer Ford F-150) and you think you are experiencing a lean condition you may need custom tuning. Please contact Power Hungry Performance at [www.gopowerhungry.com](http://www.gopowerhungry.com). They can provide custom tuning for your Evolution programmer.

## MECHANICAL MODIFICATIONS

Mechanical modifications such as headers, upgraded camshafts, displacement changes, cylinder head improvements etc. will change the airflow characteristics of an internal combustion engine. The Evolution is not tailored to take advantage of these modifications, for the best results we recommend vehicle specific custom tuning.

## FORCED INDUCTION (TURBOCHARGERS OR SUPERCHARGERS)

Turbochargers and Superchargers drastically change the dynamics/performance of the engine, and its fueling/timing needs. Additional hard parts and custom tuning are required to run a forced induction system on an engine that was originally designed as a Naturally Aspirated (NA) engine. The Evolution does not support the addition of an aftermarket forced induction kit.

*\* Power Hungry Performance can provide custom tuning for all aftermarket power adders on Fords only: Visit: [www.gopowerhungry.com](http://www.gopowerhungry.com)*

## C A R B / E P A C O M P L I A N C E

**NOTE:** *The stickers included in some products apply to products that have received CARB exemption for emissions compliance.*

This product meets the emissions compliance requirements of the California Air Resources Board and Federal Environmental Protection Agency and is legal for sale and use on pollution-controlled vehicles operated on public streets and highways. It must be installed and operated according to the instructions provided in this user's manual. Included with this product is a sticker like the one pictured for you to keep in your vehicle. You can either apply it somewhere on the vehicle (e.g., the inside end of driver's door) or simply store it in your glove box. The purpose of these stickers is to inform anyone who may have questions regarding the use of your Edge product and how it affects emissions. For example, it would be something to show an emissions technician if questioned when taking your vehicle in for an emissions check to let him/her know the product is CARB emissions compliant.

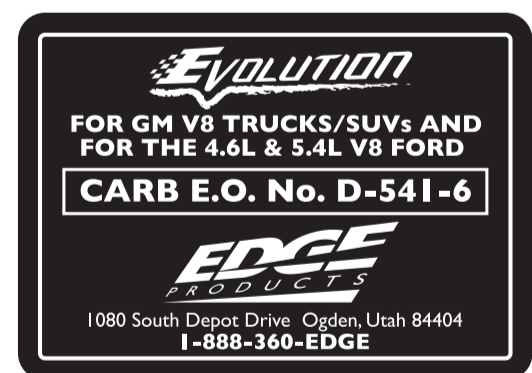

## PRODUCT REGISTRATION

**PLEASE** take the time to register your product on line at:  
[www.edgeproducts.com](http://www.edgeproducts.com).

Follow the instructions at link:

[http://www.edgeproducts.com/product\\_registration.php](http://www.edgeproducts.com/product_registration.php)

### *BENEFITS OF PRODUCT REGISTRATION*

**-Your Safety** - Registering your product allows us to know exactly which product you have and provide important product updates to you that improve the quality and/or safety of the product.

**-Enhanced Features** - Almost all Edge products are easily updated via the internet. We are constantly adding new features and improvements to our product that we know you will want to enjoy.

**-Confirmation of Ownership** - Provides a record in case of product loss, theft, or required warranty work. When you call us for support our team will already have much of the information they need to help you.

**-Improved Product Development** - Helps us better understand you (our customers) and design products that meet your needs.

**-Special Offers** - Allows us to inform you about special offers on accessories and/or new products that fit your vehicle and enhance your driving experience.

## PRODUCT INFORMATION

### INTRODUCING THE CS AND CTS MODELS

From the pioneers in display-based technology and engine performance management, comes the CS (Color Screen) and CTS (Color Touch Screen) for popular late model vehicles. Edge has reinvented 3 of its most popular lines – the Evolution, Juice/Attitude, and Insight– with an all-new look and exclusive new features.

### THE BREAKDOWN

Three product lines, two screen options. It's just that simple. Edge has taken its best-known products – the Evolution, Juice/Attitude, and Insight, – and given them a fresh look, improved features and benefits, and pricing that will make the competition obsolete. Consumers can pick the product that suits their needs and then choose the screen option that best fits them.

## THE CS (COLOR SCREEN)

The CS – an acronym for Color Screen – has a familiar feel of Edge’s popular legacy Attitude and Evolution. This new full-color digital display features a ruggedized case, user-friendly buttons, an easy-to-navigate menu, and a light sensitivity sensor that automatically adjusts the brightness for improved night viewing.



## THE CTS (COLOR TOUCH SCREEN)

The CTS – an acronym for Color Touch Screen – is the pinnacle of what made Edge popular: Innovation. The CTS model features a full-color, button-free, touch-screen digital display; an easy-to-navigate menu; a light sensitivity sensor that automatically adjusts the brightness for improved night viewing; and a video-in jack that supports most off-the-shelf backup cameras or DVD players with an RCA jack.





## USING THE MANUAL

This manual includes coverage of the best known Legacy Edge Products – the Evolution, Juice/Attitude, and Insight. You may be familiar with the products and this manual will help you navigate through their operation on the CS/CTS device platform. Most of the menus, features and operation are similar and common to each other for the various products.







When features or operation are different, the various sections or paragraphs will be identified to the product. (e.g., Evolution, Attitude, Insight...). Look for those pages or sections related to your product and then choose the screen, features or option that best fit your needs.

***NOTE: The display screens, menu items and operating instructions contained in the following pages are meant to cover a wide variety of CS/CTS devices (Evolution, Attitude, Insight, ect.) as well as multiple vehicles (Ford, Chevy, Dodge). Every menu and feature is not shown in detail for each device, but selection and changes are made in a similar manner using the different devices. Also, some of the options/features covered in the operating instructions may not apply to your device or vehicle. Your CS/CTS device will display only the menus, options and features that are unique to your device and those features and options your vehicle's computer system is capable of executing. As such, not every menu and screen is explained in this manual. Most are user intuitive and similar in functionality.***

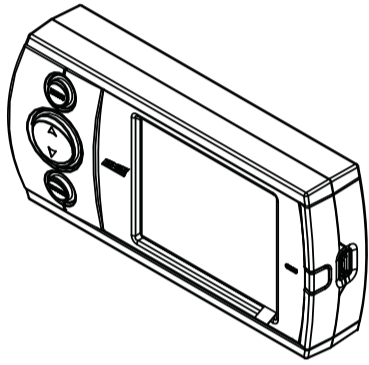
For specific information regarding horsepower, torque, and other features available for this product:

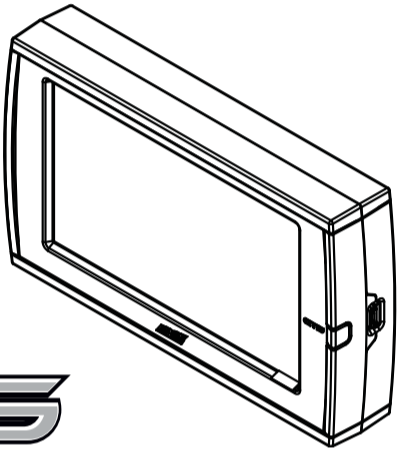
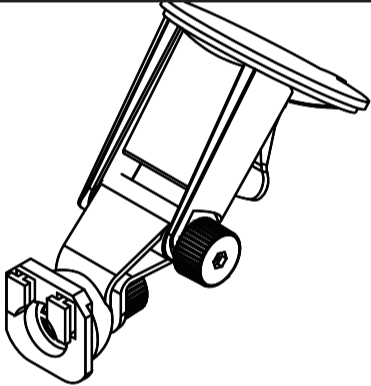
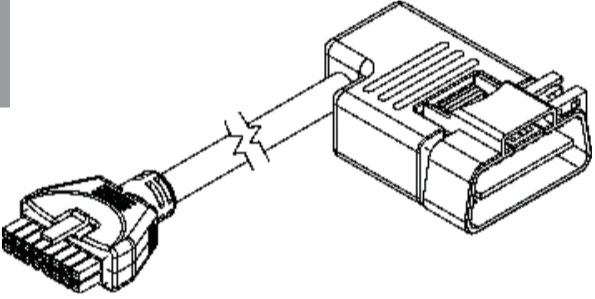
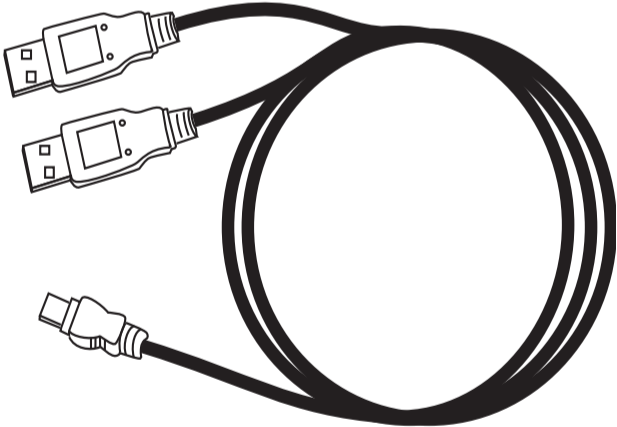
1. Go to [www.edgeproducts.com](http://www.edgeproducts.com)
2. Type the part number of your product in the “KEYWORD/PART# SEARCH” and press enter.
3. Click the link under “Description”
4. Scroll down to the “DOWNLOAD VEHICLE SPECIFIC HORSEPOWER, TORQUE, AND FEATURES CHART” link and click on it.
5. Find the information that is specific to your make and model.

**PARTS INCLUDED**

<i>Supplied Items</i>		<i>Suggested Tools</i>	
<ol style="list-style-type: none"> <li>1. CS or CTS Device</li> <li>2. Arkon Windshield Mount</li> <li>3. OBDII Cable</li> <li>4. Mini USB Cable</li> <li>5. CD (contains manual/update software)</li> <li>6. Alcohol Wipe</li> <li>7. Zip Tie Packet</li> </ol>		<ul style="list-style-type: none"> <li>• Flat head screwdriver</li> <li>• Cutting Pliers</li> </ul> <p>(NOTE: Refer to #4 below. Plugging both USB connectors into you computer will give you the best results.)</p>	
<b>1</b>	 	<b>CTS</b>	
<b>2</b>		<b>3</b>	
<b>4</b>		<b>5</b>	
<b>6</b>		<b>7</b>	

**NOTE:** *The Parts Description section of this manual describes each of the main parts included in your CS/CTS kit both physically as well as functionally. Refer to the “CS/CTS Quick install Guide” for proper installation and windshield mounting.*

### CTS DEVICE

The CTS device provides you with an interface to change the performance programming on your vehicle as well as gives you a multi-color touch screen display which allows you to monitor multiple vehicle parameters in real time. It is equipped with a large touch screen, a USB port (for PC communication and electronic updates), a 16-pin connector (for main vehicle communication), a video-in jack, and a six-pin accessories connector which allows you to further extend the capabilities of the device (see the accessories page in the back of the manual).

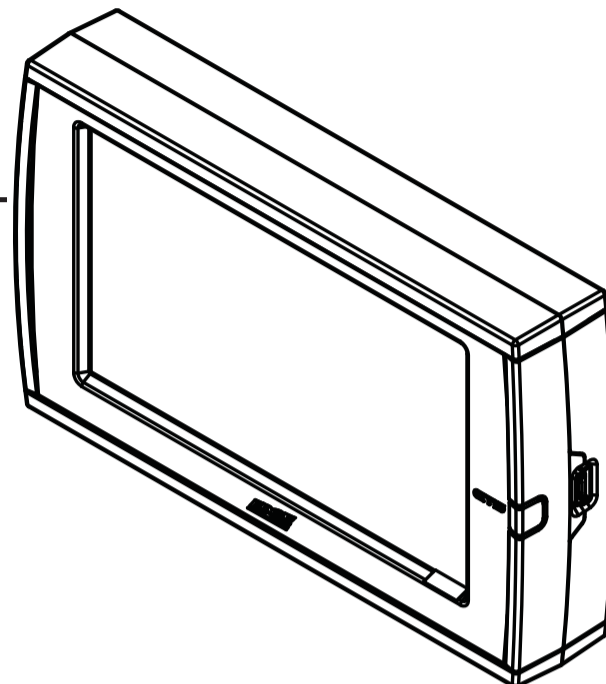

### CS DEVICE

The CS device provides you with an interface to change the performance programming on your vehicle as well as gives you a multi-color screen display which allows you to monitor multiple vehicle parameters in real time. It is equipped with a full color screen, a Menu button, Up and Down Arrow button, an Enter button, USB port (for PC communication and electronic updates), a 16-pin connector (for main vehicle communication), and a six-pin connector.

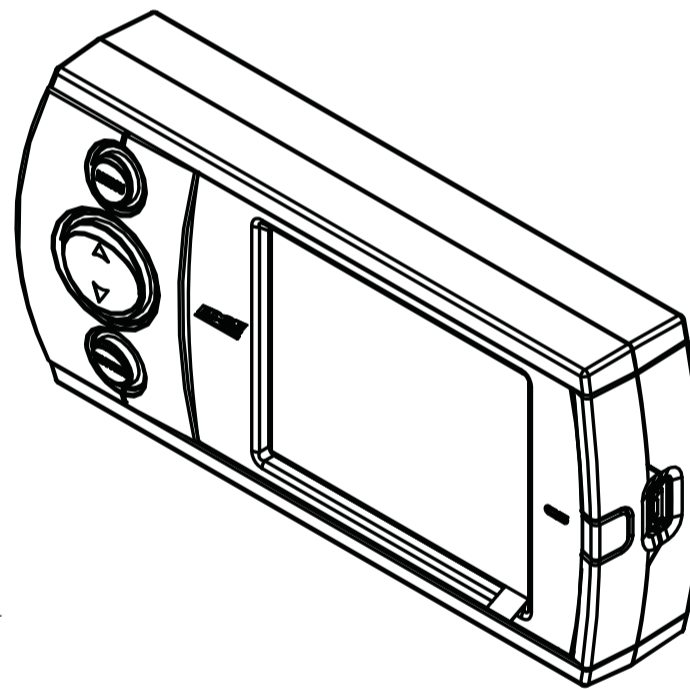

### CS/CTS WINDSHIELD MOUNT

The windshield mount supplied with your CS/CTS kit is designed to give you flexibility in mounting your device anywhere you'd like on your windshield. It is equipped with a locking suction cup, a vertically adjustable arm, and a 180° pivot head which allows you to fine tune the viewing angle to your preference.

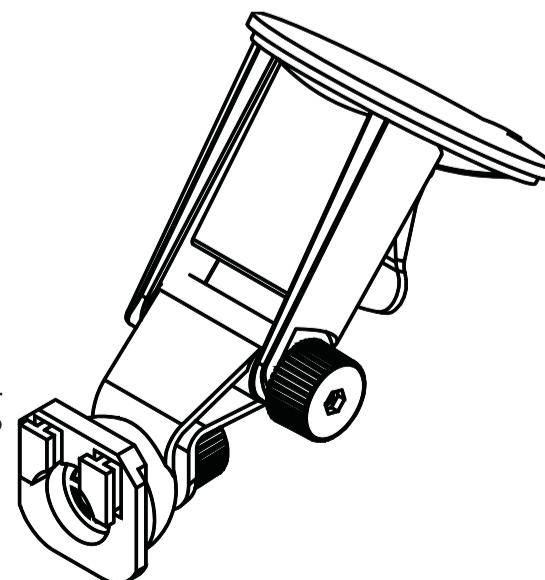



### CS/CTS OBDII Connector

The OBDII connector/cable has two plugs, a smaller male 16-pin plug that connects to the back of your device, and a larger rectangle style 16-pin male connector which connects to the OBDII port located under the driver's side dashboard. The purpose of this connector is to provide a communication link between your vehicle and your device as well as provide a power and ground source. (NOTE: This cable must be plugged into both the OBDII port as well as the CS/CTS in order for the Display to function.

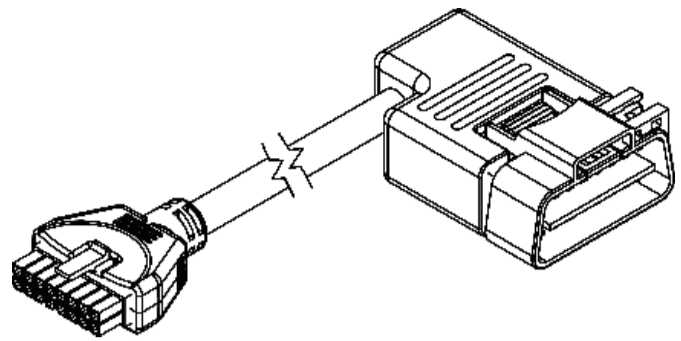

### MINI USB CABLE

The USB cable is used to connect your device to your PC in order to perform firmware and calibration updates using Edge Products Fusion software. It is recommended you plug both USB connectors into the computer, and complete the Fusion software installation before connecting the device.

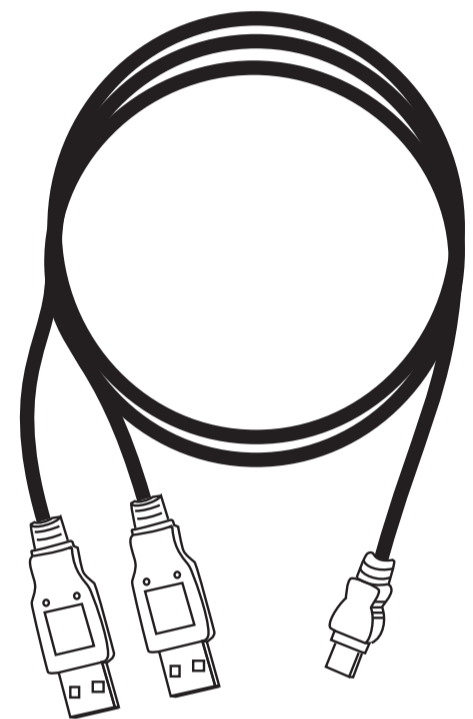

### CS/CTS COMPACT DISC

The CS/CTS compact disc contains the Fusion update software, and PDF files for the Installation manual as well as the quick install guide.



Also includes the NEW MyStyle™ Software to customize your display screen.

### ALCOHOL PAD

The alcohol pad is supplied for cleaning the windshield prior to mounting the suction cup equipped Arkon mount.



### ZIP TIES

The zip tie packet contains zip ties to help you secure the OBDII cable out of the way under the dash.

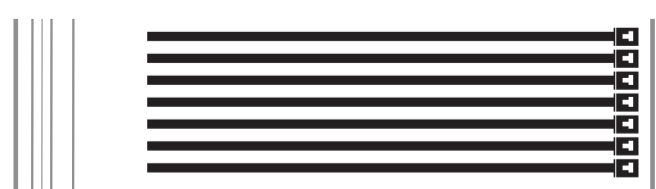

## CS GAUGE SCREEN LAYOUT

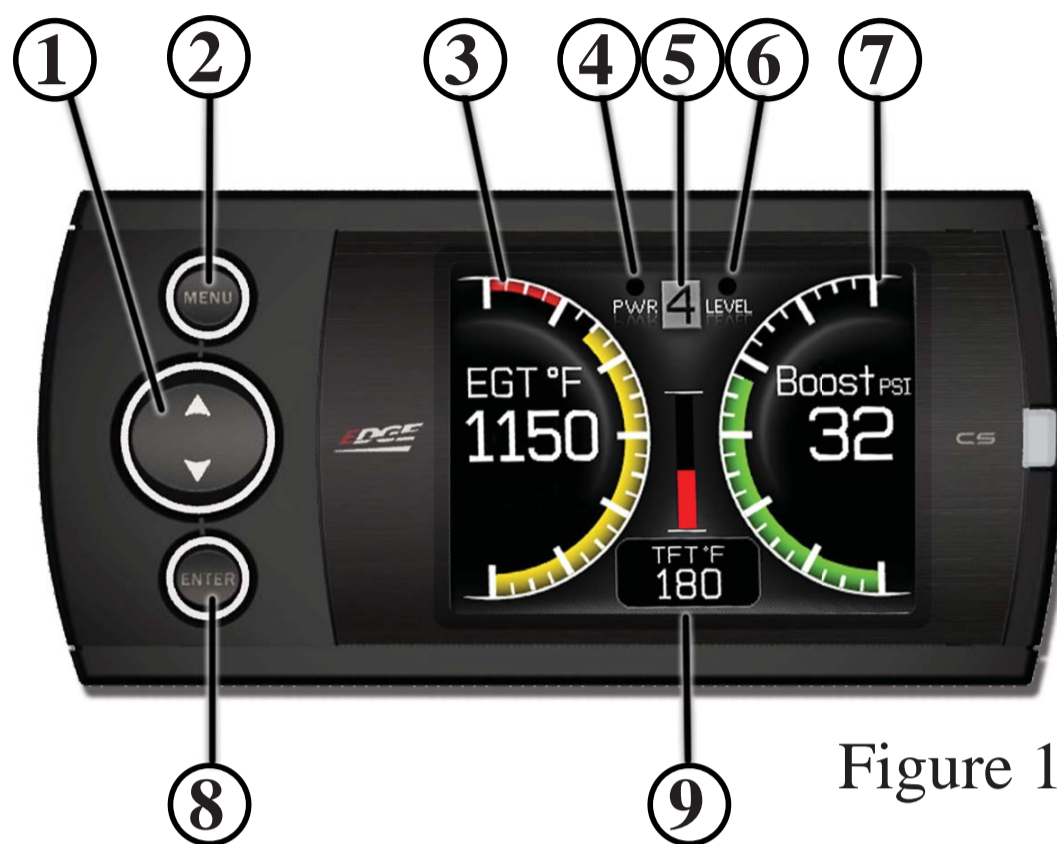



Figure 1

1. **Up/Down Arrow Button** - On the ATTITUDE gauge screen these buttons are used to toggle the power level up/down. The EVOLUTION gauge screen may use these buttons in future feature enhancements. The INSIGHT uses these to adjust power levels when using EFILive™. In the menus these buttons are used to select the menu items and increase or decrease values.
2. **Menu Button** - The menu button gives you access to the main menu or can be used to exit out of a menu screen.
3. **Left Gauge** - The left analog gauge. The displayed parameter for all gauges can be changed by pressing the enter button, choosing the desired gauge, and selecting a different parameter from the list.
4. **Alert Indicator** - The alert indicator light will illuminate (red) when an alert limit is exceeded. When this light contains an "R," it indicates that your Diesel Particulate Filter (DPF) equipped vehicle is performing a regeneration cycle. If the light is blue and contains a wrench  your Maintenance Manager is letting you know a maintenance item is ready to be serviced.
5. **Power Level Indicator** - The power level indicator represents the current power level. 0 represents stock. I stands for Insight which produces no additional horsepower.
6. **Back-down Indicator** - (ATTITUDE with JUICE) The back-down indicator light will illuminate (yellow) when the Juice module is decreasing power added by the device, when approaching or exceeding the back-down set point limit.
7. **Right Gauge** - The right analog gauge.
8. **Enter Button** - The enter button when pressed from the main screen will allow you to change the gauge parameters (PID, Alert Settings, and Gauge Color). In the menus it allows you to select the highlighted option.
9. **Center Gauge** - The center gauge.



## CTS GAUGE SCREEN LAYOUT



Figure 2

1. **Main Menu button** - The main menu button gives you access to the main menu.
2. **Left Gauge** - The left analog gauge. The displayed parameter for all gauges can be changed by simply touching the gauge and choosing a different parameter from the list. Use this menu to choose a new PID, change alert settings, and choose a new gauge color.
3. **Up/Down Arrow Buttons** - On the ATTITUDE gauge screen these buttons are used to toggle the power level up/down. The EVOLUTION gauge screen may use these buttons in future feature enhancements. The INSIGHT uses these to adjust power levels when using EFILive™. In the menus these buttons are used to select the menu items and increase or decrease values.
4. **Alert Indicator** - The alert indicator light will illuminate (red) when an alert limit is exceeded. When this light contains an "R," it indicates that your Diesel Particulate Filter (DPF) equipped vehicle is performing a regeneration cycle. If the light is blue and contains a wrench  your Maintenance Manager is letting you know a maintenance item is ready to be serviced.
5. **Power Level Indicator** - The power level indicator represents the current power level. 0 represents stock. I stands for Insight which produces no additional horsepower.
6. **Back-down Indicator** - (ATTITUDE with JUICE) The back-down indicator light will illuminate (yellow) when the Juice module is decreasing power added by the device, when approaching or exceeding the back-down set point limit.
7. **Right Gauge** - The right analog gauge.
8. **Lower Left Gauge** - The lower left digital gauge.
9. **Center Gauge** - The Center analog gauge.
10. **Lower Right Gauge** - The lower right digital gauge.



## GAUGE DISPLAY INFORMATION

## GAUGE LAYOUT OPTIONS

This feature allows you to adjust gauge display information directly from the main gauge screen. To adjust what the gauge displays, follow these instructions:

1. **CTS** - While viewing the main gauge screen, touch the gauge you would like to modify.
2. **CS** - While viewing the main gauge screen, press the enter button and select the gauge location you would like to modify.

The following screen will appear.

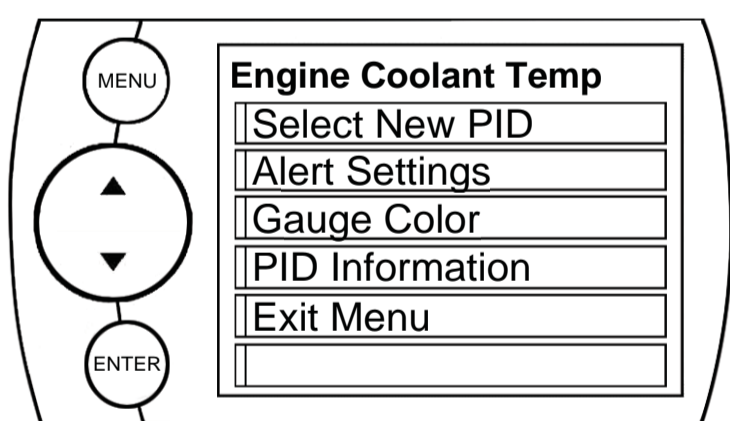

(Figure 2.1)

## SELECT NEW PID

Select the PID that you would like to monitor from the provided list.

## ALERT SETTINGS

For more information, refer to the “**ALERT OPTIONS (SETTINGS)**” section under the “**OPTIONS MENU**” section of this manual.

## GAUGE COLOR

Choose a color from the list. This will modify the gauge indicator. *NOTE: Only Analog gauges can be modified.*

## PID INFORMATION

This briefly explains what the selected PID is and/or what it monitors.

## EXIT MENU

Brings you back to the main gauge screen.

# NAVIGATING THE MAIN MENU

## ATTITUDE

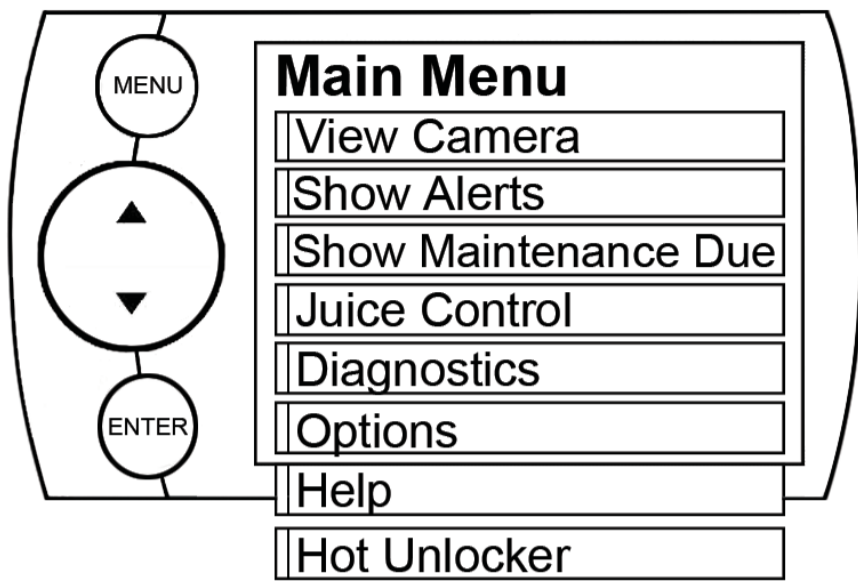

Figure 3

## EVOLUTION

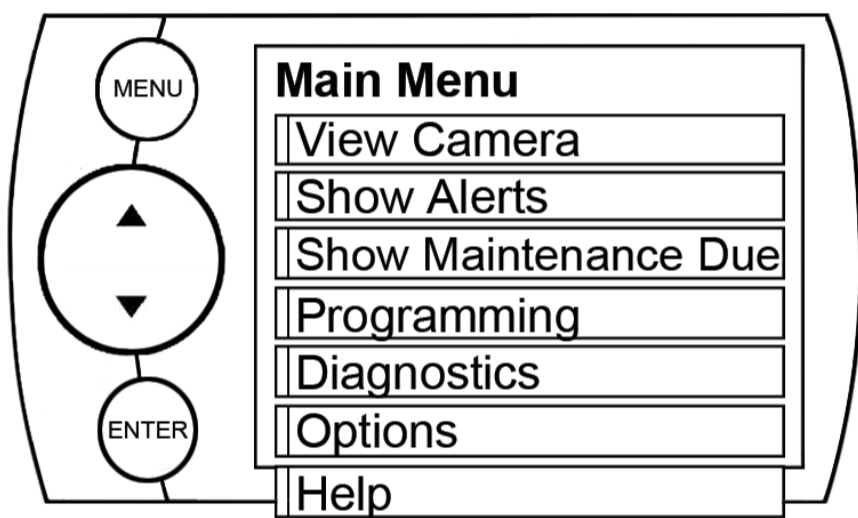

Figure 4

## INSIGHT

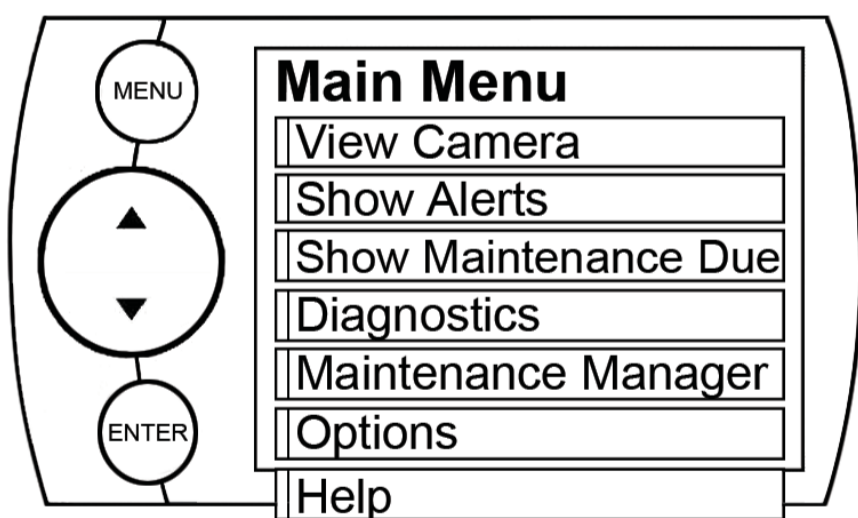

Figure 5

**NOTE:** The following will only show under certain circumstances:

1. "View Camera" will only show if a camera is plugged into the video jack located on the back side of the CTS. Does not apply to CS.
2. "Show Alerts" will only show if an alert is active.
3. "Show Maintenance Due" will only show if your Maintenance Manager is turned on and a maintenance item is due.

## MENU BUTTONS

Both the CS and CTS devices provide you with the following three buttons for navigating the menu system:

**Menu:** The Menu button allows you to enter the main menu.

Once you are in the main menu you'll use the Menu button to return to the previous screen.

**UP/Down Arrow:** The Up/Down Arrow button will allow you to toggle up or down through the menu options, you'll notice it highlights each option as you toggle.

**Enter:** Pressing the enter Button will select the currently highlighted option.

**NOTE:** With the CTS device you can simply touch the option you'd like to select on the menu screen. As a touch screen device it will automatically select the option you've touched and advance you to the selected option screen.

## VIEW CAMERA (CTS)

**NOTE:** If you have a back-up camera or other RCA device connected to the CTS, the view camera menu item will be

*active within the main menu.*

1. Selecting “View Camera” in the “Main Menu” list, will allow you to view the camera image. If you would like to stop viewing the camera image, touch the screen and the main gauge screen will re-appear.



**WARNING:** Do not rely solely on the camera image for backing up. It is possible for the camera image to freeze. Always use your mirrors, and look behind you before backing up. Objects in the view may be closer than they appear. If you are using a camera not manufactured by Edge Products, the image may be reversed.

## SHOW ALERTS

The CS/CTS device is equipped with an alert system that notifies the user when vehicle parameters are outside a user-defined value. There are a few ways the CS/CTS alerts are indicated and accessed:

### MAIN SCREEN METHOD

If one of your gauges on the main screen (Refer to Figures 1 & 2) contains the alert parameters, 2 things will occur:

1. The alert notification will sound only if it is turned on. (Sound will turn off after a few seconds

depending on the sound duration you have set)

2. The gauge back-light will flash. (Will continue flashing as long as the parameter is outside the user-defined value)

**NOTE:** *The alert sound and flashing will discontinue once parameter is no longer out of the user-defined value.*

### ALERTS SCREEN METHOD

This Alerts screen (Figure 6) will show all parameters for which an alert has been set. If an alert value is outside the user-defined setting, it will flash red. The Alerts screen will stay in view for a minimum of three seconds, until no alert condition exists, or until the screen/menu button is touched, at which point it will return to the main gauge screen.

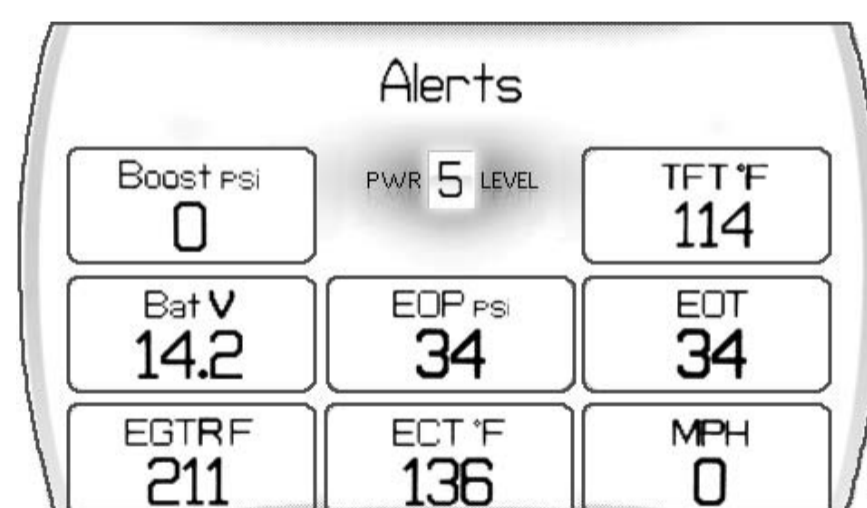

Figure 6

**NOTE:** *This menu only appears when there is an alert active. It shows the current, active alerts and their current values.*



If you have exited the Alerts screen (Figure 6) you can return to the screen by entering the “Main Menu” and selecting the “Show Alerts”.

*NOTE: For more information on how to set the Alerts, Refer to the: “ALERT SETTINGS (OR OPTIONS)” section of this manual.*

**SHOW MAINTENANCE DUE**

This feature allows you to quickly view which Maintenance Item is up for service. Refer to the MAINTENANCE MANAGER section of this manual for more information.

**DIAGNOSTICS**

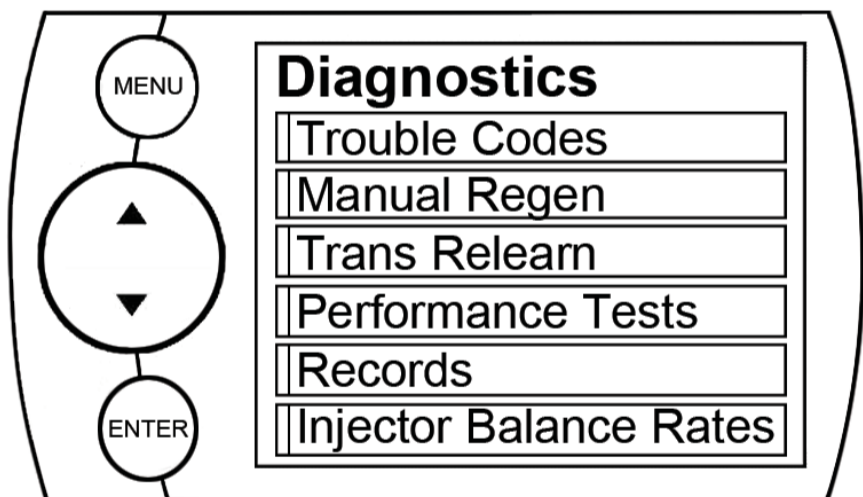

Figure 7

*NOTE: Not all options in Figure 7 will be available. The availability of these options will vary due to the product you purchased and your vehicle.*

**TROUBLE CODES**

When your PCM detects a problem with your vehicle it sets a trouble code. Use this menu item to retrieve the code, and to clear it after retrieval. See Figure 8.

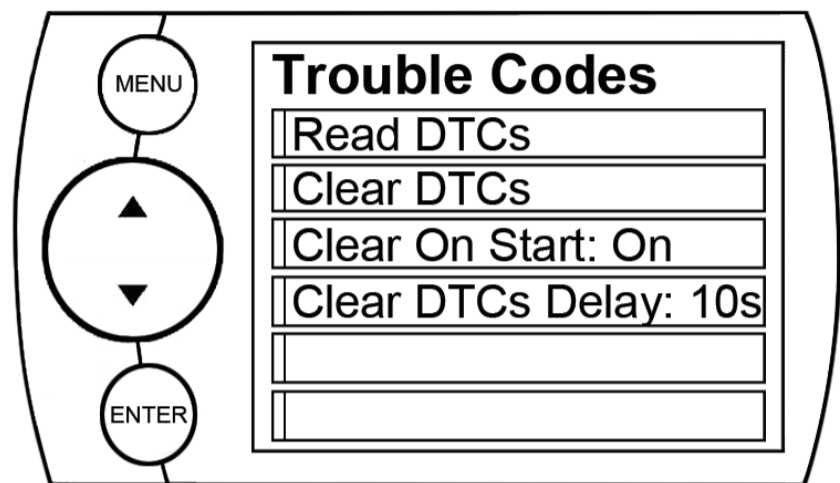

Figure 8

The diagnostics scanner included with the CS and CTS devices is a powerful tool that allows you to view and clear Diagnostic Trouble Codes (DTCs) on your vehicle. DTCs are the messages your vehicle’s computer stores when it detects a problem with your vehicle. The “Check Engine” light on your dash is activated by the presence of most DTCs (some DTCs may not set a check engine light).

**READ DTCs**

If you want to read the DTCs on your vehicle follow these instructions:

1. Make sure the Key is in the **ON position**.

2. Select the **Trouble Codes** from the **Diagnostics** menu.
3. Select **Read DTCs** from the menu.

### **CLEAR DTCs**

After you have retrieved the trouble codes and written them down, you can clear the trouble codes by selecting **Clear DTCs** from the menu. This will erase any of the codes currently set. If the codes come back we recommend you see a qualified mechanic who can accurately diagnose/repair the problem.

### **CLEAR ON START**

This feature is not available on all products. In some instances, such as the Juice Racing Products, trouble codes may need to be cleared every time the truck starts or the truck will go into limp mode. When using this feature, follow all on-screen instructions.

**NOTE:** *Fords and Chevy's are able to clear codes while the truck is running. Dodge trucks may require you to clear only when the key is on and the engine is not running.*

### **CLEAR DTCs DELAY**

This option is not available on all products. The delay sets

the time the Juice waits to clear DTC's on start (after key on).

### **MANUAL DPF REGENERATION**

Manual regeneration allows you to manually clear out the DPF. This can be helpful prior to heavy towing, racing, or prior to going off road in dead or dry shrubs/grass.

Completing a manual regeneration cycle will clear the soot mass in the filter, and lower exhaust back pressure/free up exhaust flow. It will be helpful to do this before any competition such as drag racing or tractor pulling. It's also helpful to use if you're going to be in a situation where you don't want the truck computer to initiate the Active Regeneration cycle on it's own, (i.e. heavy towing, or driving where dry grass, shrubs, or other combustibles are present). You can do this by:

1. Selecting the **Manual Regen** option in the **Diagnostics** menu. (Figure 7)

When manually initiating a regeneration cycle some vehicles will require a drive cycle (i.e. you have to drive the vehicle some distance) while others may allow you to initiate a Service Regeneration where you can leave the vehicle parked and engine running. If the latter



is the case, be sure to use the following guidelines:

1. Park the vehicle outdoors and keep people, other vehicles, and combustible material away from it.
2. Do not leave the vehicle unattended.
3. Do not connect any shop exhaust hoses or vents to the tail pipe.

**CAUTION:** *Exhaust temperatures may be greater than 300 C (572 F) during service regeneration.*

**CAUTION:** *Due to the elevated temperatures during this procedure, open the hood and keep the front of the vehicle away from anything impeding air flow to the radiator.*

### **DPF REGENERATION**

If you own a newer diesel powered vehicle, your vehicle is equipped with a diesel particulate filter (DPF). This filter is used in conjunction with a diesel oxidation catalyst. Together they work to reduce the amount of soot and emissions emitted from the tailpipe. As soot builds up in the DPF it will begin restricting the filter. The soot that gathers is automatically purged in one of two ways: Passive Regeneration & Active Regeneration. Both methods occur

automatically and require no action on your part. During either of these regeneration methods, you may notice an increase or change in the exhaust noise & increased EGT.

### **PASSIVE REGENERATION**

Passive regeneration occurs when the exhaust temperature (EGT) reaches an appropriate level in order to oxidize or burn soot to clean the DPF. This method can happen as a result of normal engine operating conditions, typically when the engine reaches an EGT high enough to burn off the soot (i.e. heavy towing, high load conditions etc.) If EGTs do not get hot enough to cause passive regeneration, then your truck's engine-control system automatically initiates an **active regeneration**.

### **ACTIVE REGENERATION**

During active regeneration, the truck computer cleans the DPF by raising the exhaust temp to a point where the soot is burned away. This is accomplished through various engine actions which raise the EGTs in the oxidation catalyst/DPF system to a level where the soot is burned off. After the soot is burned off, the EGTs and



back-pressure (restriction) fall back to normal levels. In order to help you know the status of DPF Regeneration, the device will display an “R” in the “Alert Indicator” section of the screen anytime active regeneration is happening.

**TRANSMISSION RELEARN**

Read through the screen information on your device to understand how this feature works.

*NOTE: This feature is available for the following only:*

*Evolutions: All 2001-2010 GM Diesel trucks.*

*Attitudes: 2001-2005 GM Diesel trucks.*

**PERFORMANCE TESTS**

Performance tests can be helpful for measuring performance gains after vehicle modifications have been installed (intake, exhaust, programmers, etc). Use this menu to access 0-60 and Quarter mile tests. (Figure 9)

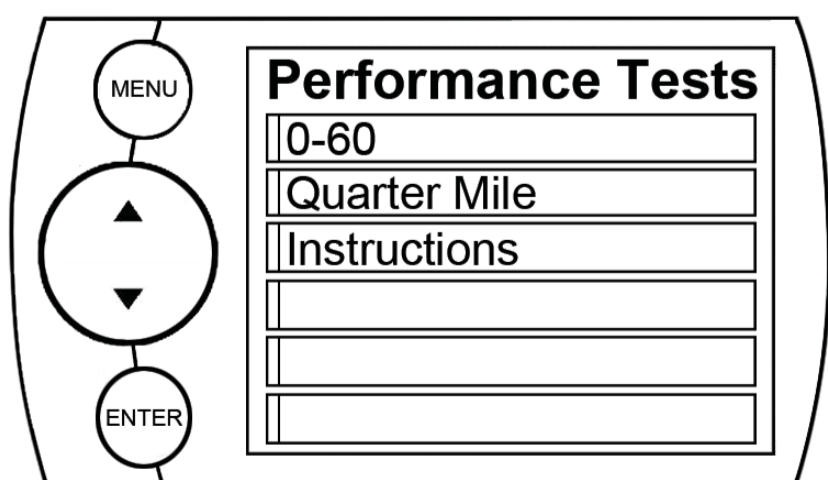

Figure 9

**WARNING:** Do not use the Performance Tests feature to break any traffic laws.

The CS and CTS devices allow you to test the performance of your vehicle by timing 0-60 and quarter mile runs. (Instructions are provided in the Instructions menu). The results recorded by the Performance Test features, will likely differ from what you’ll see on a drag-strip or other racing venues. Incorrect speedometer calibration, data sample rate, and tire slippage can cause miscalculations in the displayed results.

**0-60 TEST**

Select the **0-60** menu item and the following screen will appear. (Figure 10)

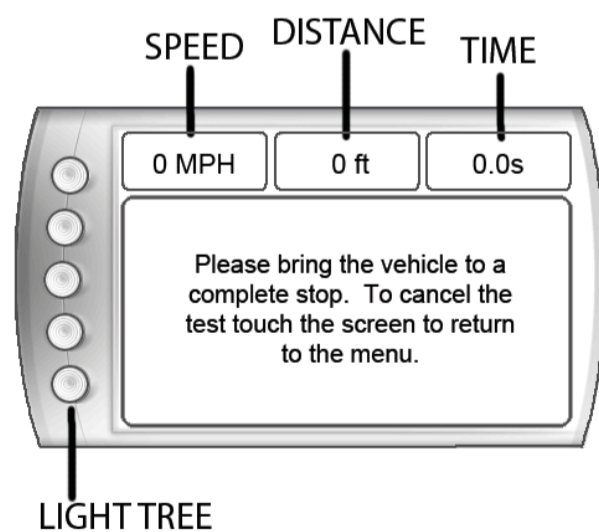

Figure 10

After bringing the vehicle to a stop, follow the directions noted on the screen.

## QUARTER MILE TEST

Select the **Quarter Mile** menu item and Figure 10 will appear. After bringing the vehicle to a stop, follow the directions noted on the screen. The Quarter mile test will prompt you with a drag strip style light tree. If you watch the circles on the left they will light up yellow, then green. If you go before green appears then a red light will light up in the bottom showing that you started too early. If you don't start early then you will see a green light remain in the bottom circle.

When you've finished the quarter mile run the device will display the ending mph, the distance traveled in ft., and the elapsed time it took to reach 1/4 mile. In addition it will graph your MPH vs Speed so you can better analyze the run.

## RECORDS

Records contain certain parameters for later review. This is useful on the drag strip, at a sled pull, or when you are trying to trouble shoot a problem/bug.

## INJECTOR BALANCE RATES

Injector Balance Rates are used to determine if all the injectors are operating within the correct tolerances.

**NOTE:** *Only available on certain models.*

If you experience a misfire, knock, excessive smoke, or rough running condition with no DTCs, the Injector Balance Rate option can help identify faulty injectors.

The balance rates are the fuel adjustments for each individual cylinder based on the variations in engine crankshaft speed. The balance rates will change depending on if the transmission is in Neutral or Drive. Monitor and record all cylinder balance rates in drive and neutral. Injectors that read a higher numerical value than +/- 4.0 ( e.g. +/- 5,6,7 etc.) in park/neutral and +/-6.0 in drive may identify faulty injectors.

If the balance rates show a possible faulty injector, we recommend you consult a professional diesel mechanic who can verify this test and also perform a Cylinder Power Balance test to diagnose faulty injectors.

## RUNNING THE TEST

1. Select **Injector Balance Rates** from the **Diagnostics** screen. You'll be prompted by the following screen. (Figure 11)



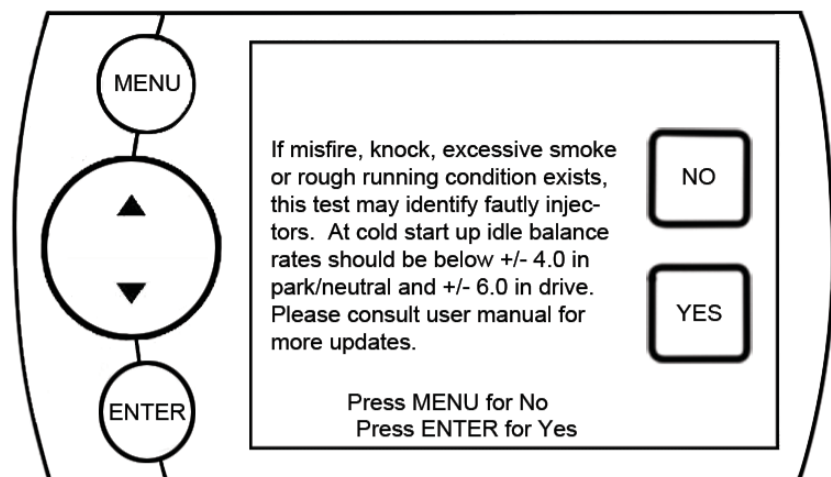

Figure 11

2. **Select Yes.** Figure 12 will appear. Each box represents an Injector. This screen is where you'll want to compare the injector balance rates in both Park and Drive.

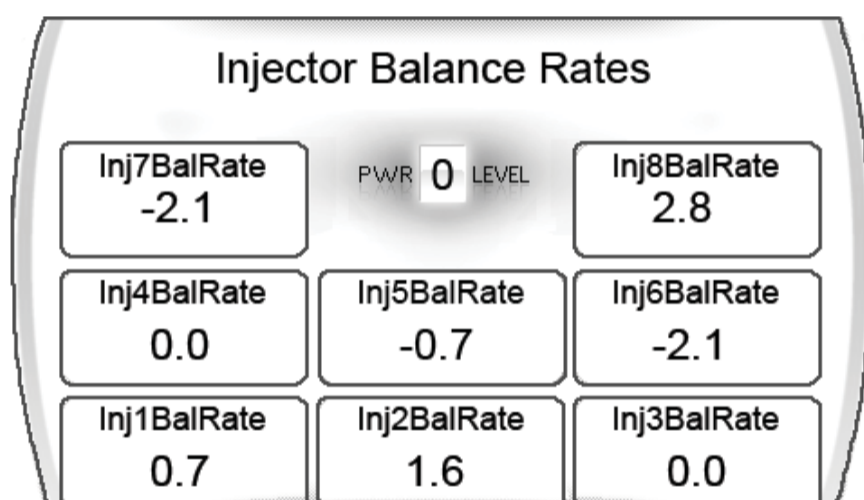

Figure 12

**NOTE:** Figure 12 injector balance screen shot represents a truck with injector balance rates that are acceptable. The sample was taken in park. You can see that there are no numbers higher than +4.0 or -4.0 on the screen, so it's safe to assume the injectors are working properly.

## MAINTENANCE MANAGER

**NOTE:** The Maintenance Manager may not yet be available on your device. Availability will depend on software releases specific to your vehicles' make and model.

The Maintenance Manager calculates the odometer value of your vehicle using the vehicle speed and time.

**NOTE:** The Maintenance Manager odometer reading may become out of sync with the actual dash odometer reading. You may need to periodically update the Maintenance Manager's odometer value. It is important to note that the CS/CTS only tracks miles traveled when the main gauge screen is being displayed. If you are in the menus while driving, your miles are not calculated.

## ODOMETER SETUP

1. Locate the "Maintenance Manager" by entering the "Main Menu".
2. Turn "ON" the Maintenance Manager. (If it is turned off, you will not be notified when service is due.)



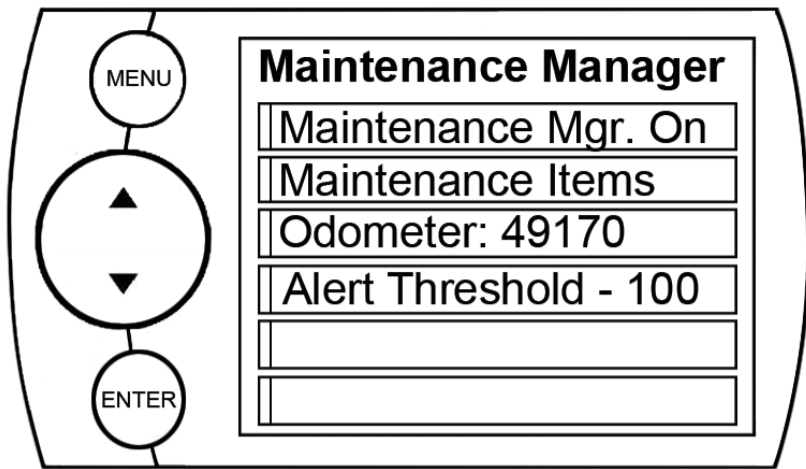

Figure 13

3. Choose “Odometer” to set your current Odometer reading. The screen shown in Figure 14 will appear.

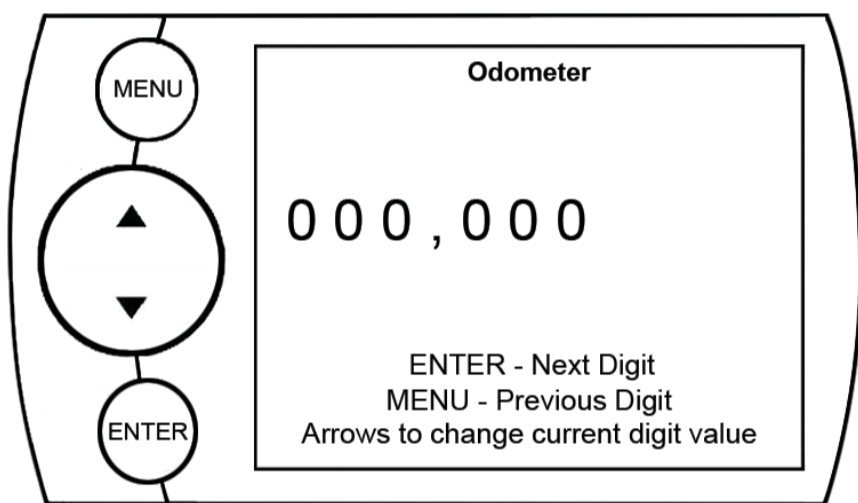

Figure 14

4. Use the Arrow buttons to adjust the values up or down.
5. Press the Enter button to move to the next Digit.
6. Once all digits have been entered, the Maintenance Manager screen will reappear showing your entered value. (See example in Figure 13. A value of 49,170 was entered).
7. Once the Odometer is entered and displayed, chose the “Maintenance Items” option.

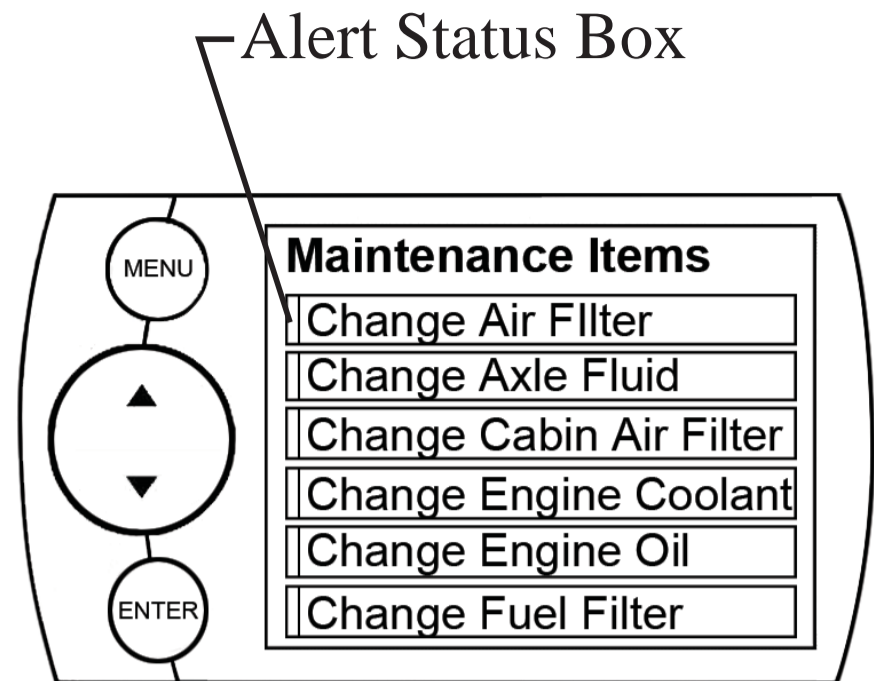

Figure 15

Other Maintenance Items not listed in Figure 15:

- Change Spark Plugs
- Change Trans Fluid
- Chk Trans Case Fld Lvl
- Inspect Brake Pads
- Lube Front Drive Shaft
- Lube Tie Rod Ends
- Rotate Tires

8. Chose the item you would like to maintain. (For demonstration purposes we will chose “Change Engine Oil”. The following steps may also be applied to all other items).

**NOTE: Refer to Figure 15. Once a Maintenance Item is turned on, the Alert Status Box to the left of the item will light up. If it is green, the item is not yet due for service. If it is yellow, the item is about to be due and within the specified Alert Threshold. If it is red,**

*the item is due for service. If it remains black, the item is not turned on. This all depends on the following settings.*

## MAINTENANCE SETUP

1. First you need to setup the interval value. In figure 16 we entered 3,000.

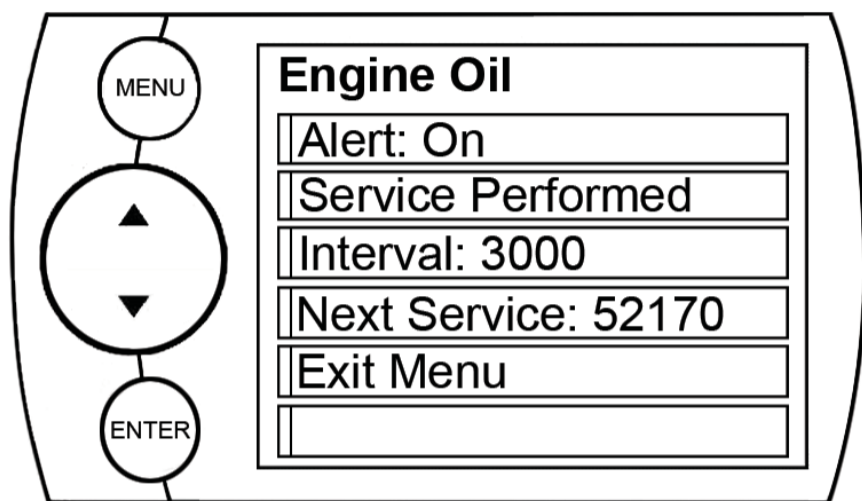

Figure 16

This means that we want the oil changed every 3,000 miles.

**NOTE:** Refer to your vehicle user manual to determine what value is recommended for each Maintenance Item.

2. Select “Service Performed”. This will automatically set the “Next Service” value.

**NOTE:** Each time your vehicle is serviced, the “Service Performed” button will need to be pushed to reset the “Next Service” Value.

3. The “Exit Menu” option will bring you back to the main gauge screen.

## ALERT THRESHOLD

The Alert Threshold value allows you to set how many miles ahead of time you want your Maintenance Manger to alert you that an item is due.

## OPTIONS MENU

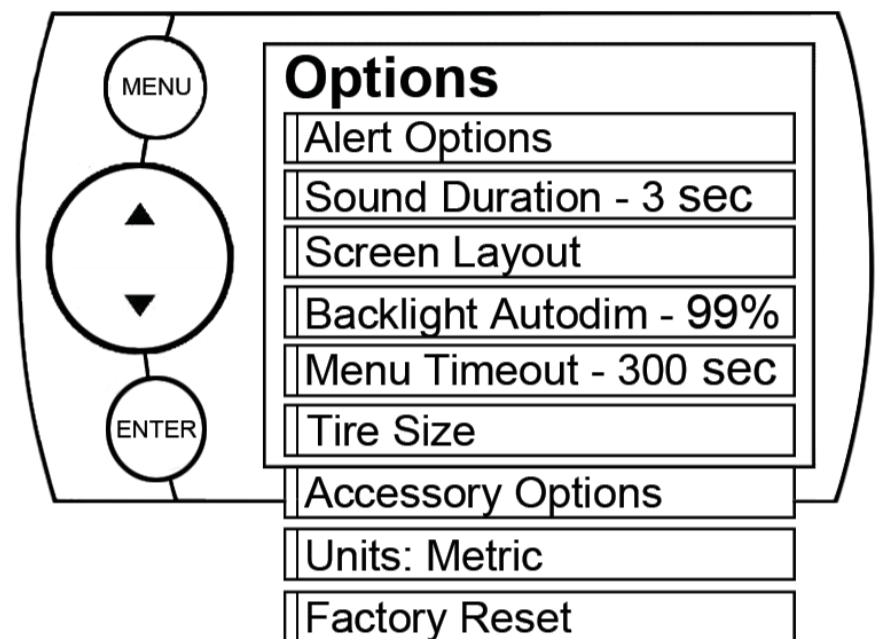

Figure 17

The Options menu contains menu items that will let you customize the device settings to your liking, as well as change the alert settings to best fit your needs.

## ALERT OPTIONS (SETTINGS)

The Alert Options (Settings) screen (Figure 18) allows you to turn the alerts on/off both collectively and individually, and also lets you set the alert values for each of the available parameters.

**To turn alerts on:**

1. Select **Alert Options** from the **Options** menu.
2. Select **Alerts are Off/On** and press enter. This will affect the entire alert system as a whole.

**To individually disable/enable an alert, or to change the alert:**

1. Select a PID in the Alert Options menu and Figure 18 will appear:

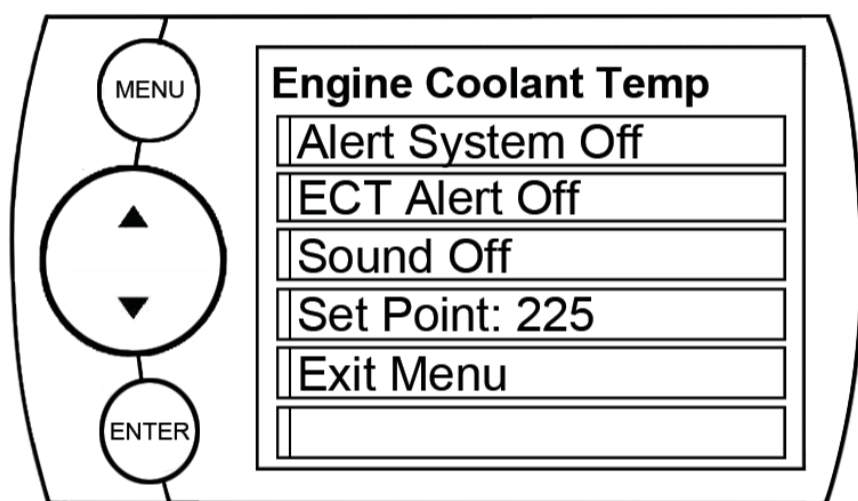

Figure 18

**NOTE:** In Figure 18 the *Engine Coolant Temperature PID is being modified.*

**ALERT SYSTEM OFF/ON**

Turns the entire alert system off/on. This disables both the alerts and sound.

**PID ALERT OFF/ON**

This turns off/on the specific PID alert you chose for Figure 14. That means that any other PID that is turned on, will remain turned on.

**SOUND**

Deals with individual PID alert sounds only.

**SET POINT**

User defined PID Value.

**SOUND DURATION**

You can adjust the duration of the alert sound by using this menu option. Simply press the up/down arrow until you have the desired sound length in **seconds.**

**SCREEN LAYOUT**

The screen Layout menu (Figure 19) allows you to choose from five different screen layout options. The Analog Gauge Screen is set as the default. Once you've selected the gauge screen you want to use, you can customize which parameters are displayed on each available gauge by:

1. CTS - Touching the parameter value on the main screen.
2. CS - Press enter button while on the main screen.

Once these are pressed, you can pick the desired PID from the list provided.



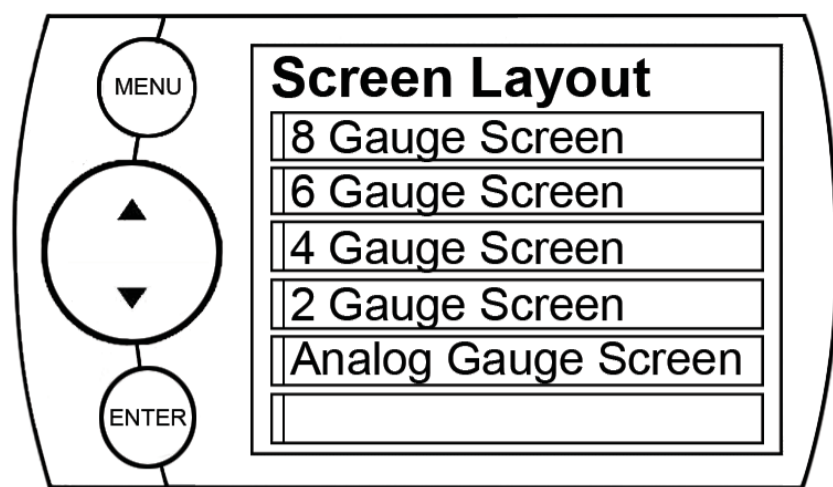

Figure 19

## BACKLIGHT AUTODIM

The CS and CTS devices both have ambient light sensors. As it gets darker outside, the device will automatically dim the screen for easier viewing. The Auto Dim feature allows you to set how far it will dim the screen.

**NOTE:** *It's best to make this adjustment at night so you can verify the screen brightness is correct. You'll need to return to the main display screen after setting the Autodim percent in order to see the changes.*

The default is set at 99%. This max setting provides the largest range between the brightest the screen gets during the daylight, and the darkest the screen will get at night. A 1% setting will provide the same brightness during the day as the 99% setting, but will remain bright with little to no change at night.

## MENU TIMEOUT

The CS and CTS devices have a built in time-out feature. The purpose of this time-out is to prevent the unit from staying powered up for excess amounts of time. If you leave the device in a menu option and then exit the vehicle, the device will stay in the menu for 300 seconds by default, after which it will return to the main screen and then power off. If left in a menu while the truck is running or the key is on it will return to the main screen after 300 seconds. You can adjust the wait time to be longer or shorter by simply using the arrows to take the time up or down.

**NOTE:** *This function only applies to menu screens. If you are viewing a parameter adjustment screen, the device will not time out. If you do not exit these screens, the device will not power-off and may discharge the vehicle's battery.*

## TIRE SIZE

If the CS/CTS is capable of re-calibrating your vehicle's speedometer, you will enter your modified tire size. If the CS/CTS can only display corrected vehicle speed, you will need to enter the values for

stock tire size and modified tire size.

Choose the method for inputting tire size that best fits your needs.

**English** = **35/12.50/16** where 35 is the height, 12.50 the width, and 16 the wheel size

**P-Metric** = **275/75/16** where 275 is width, 75 is aspect ratio, and 16 is diameter

**Circumference** = The outer circumference of the tire on your vehicle

**Height** = The Height of the tire on your vehicle

**Return to stock** = Returns values to default.

**NOTE:** *If your tire size is printed on the tire in P-Metric the easiest option will be choosing P-Metric (Figure 20).*

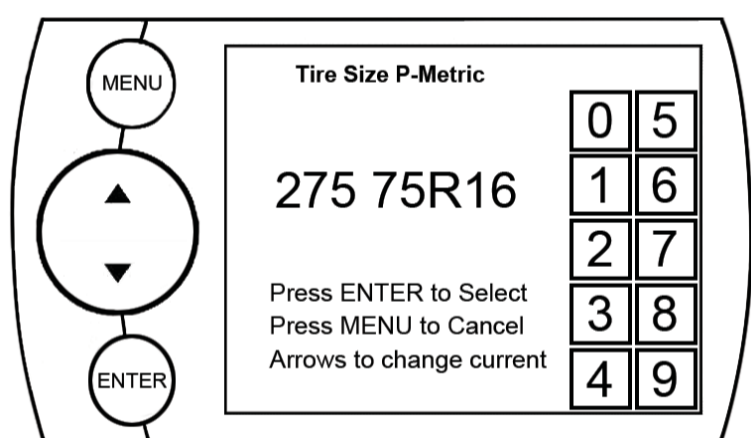

Figure 20

Use the key pad on the right hand side of the screen to enter the tire size that is currently on your vehicle. You can navigate through the numbers with the UP/Down arrows, or by touching the numbers (if you have a CTS). Once you've entered the value, hit enter and the tire size you've entered will be saved.

**NOTE: (Evolutions Only)**  
*Changing the tire size on the screen will not automatically re-calibrate the vehicle computer for tire size. You must program the vehicle in order for the changes to take place. When you program a power level to the truck the tire size will be programmed into the PCM and re-calibrate the speedometer.*

### ACCESSORY OPTIONS

Accessory options allow you to adjust add on features such as the Edge Expandable Accessories System(EAS). As other accessories are added, additional options will also be added.

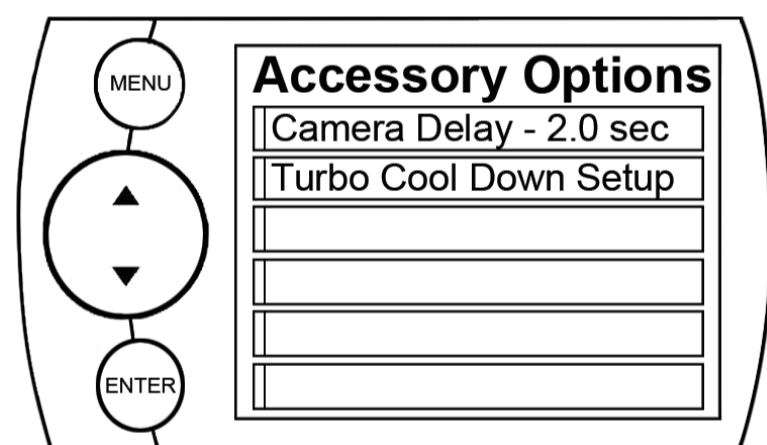

Figure 21

### CAMERA DELAY - CTS ONLY

**NOTE:** *If you don't have a camera or other RCA device connected to the CTS device, this menu option will be available but non functional.*

The CTS is designed to automatically engage the back-up



camera when the vehicle gear selector is in Reverse (the CTS must be able to detect gear position for this to function properly). The camera delay will allow you to customize the delay time for the device to switch from the main viewing screen to camera view. If this is set too short then you'll see the device blink as you move the gear selector past Reverse. If it's set too long the screen may not appear before you start backing up. Some vehicles will communicate gear position faster than others, so this menu option allows you to customize the delay.

### TURBO COOL DOWN SETUP

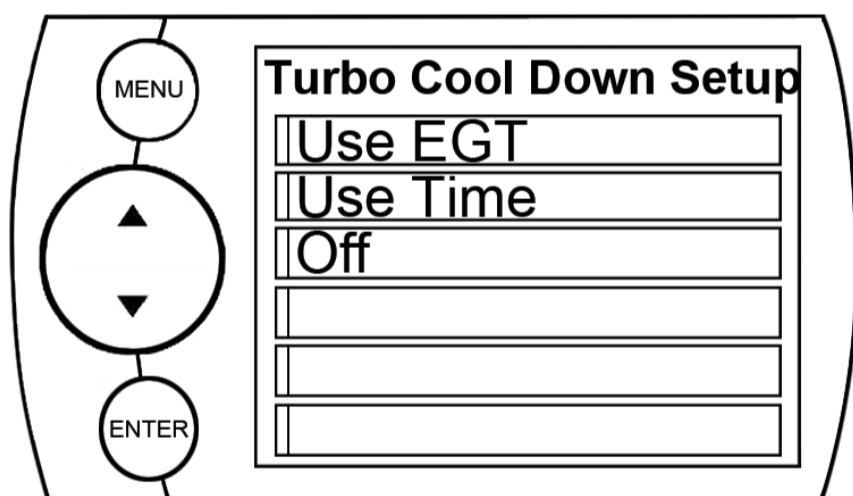

Figure 22

This menu allows the engine to continue running (after key-off) until one of three conditions are met. 1) If the EGT falls below the target set point or 2) The time set expires. 3.) Pressing either the brake pedal or gas

pedal. Your display will tell you which one pertains to your vehicle.

**NOTE:** *Dodge 07-09 trucks can be turned off using the key's panic button. Dodge 2010 trucks - lock and panic buttons at the same time.*



**WARNING:** *Do not use this feature in an enclosed area.*

**NOTE:** *The turbo timer will not function while the vehicle is regenerating (Diesel).*

### UNITS

Changing the unit option allows you to view PIDs in either Metric or English on the main gauge screen. Vehicle Speed, for example, may be viewed as either MPH or KPH. Temperature PIDs such as Engine Coolant Temperature may be viewed as either Fahrenheit or Celsius.

**CAUTION:** *If you set up your units in either English or Metric, the alert value will be the same for both. If you change from one unit to another, you will need to setup the alert values accordingly. For example, 100 MPH is not the same as 100 KPH.*



## FACTORY RESET

If you would like to revert back to the factory default settings, simply select **Factory Reset** and choose **YES** or press **ENTER**.

Many settings will be returned back to the default setting as they were when the unit was new. Any changes you've made to the alerts, the gauge screen displays, etc will be returned to the default settings provided by Edge Products.

***NOTE: Factory Reset will not return the vehicle to stock from a programmed Power Level. See Programming Power Levels section for instructions to return to stock power level.***

## HELP MENU

The Help Menu contains useful information about your device, and the vehicle it is being used on. It also contains Edge Products Contact Information, and Technical Support tools. (Figure 23)

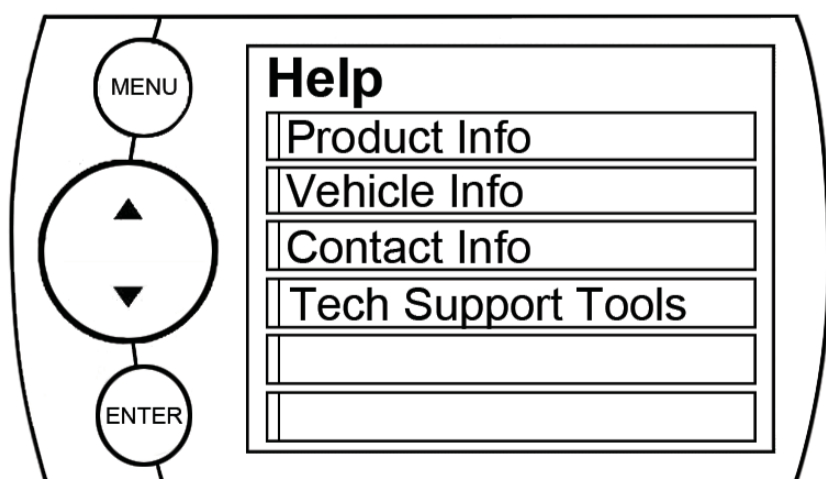

Figure 23

## PRODUCT INFO -CS/CTS

The Product Info screen contains 4 important items.

### 1. MSP430 Version

This is the firmware that runs on the Auxiliary Processor.

### 2. Firmware Version

The Firmware is the software that runs the device functions, I.E. menu systems, programming routines etc.

### 3. Calibration Version

The Calibration is the data that the device programs into your vehicle in order to achieve better performance/mileage.

### 4. Serial Number

The Serial Number is a number assigned to your particular device. This number is used to identify your device in the software update process and to Edge Technical Support.

From time to time Edge Products will release updates with improved functionality for both Firmware and Calibrations. Each of these updates are labeled with a number, the number shown in this menu represents the version that is currently on your device.

## PRODUCT INFO - EAS

If you have an EAS device installed on your vehicle and plugged into your CS/CTS

device, another Product Info screen will pop up. It will list your **EAS device's Firmware Version** as well as its **Serial Number**.

requested by Edge Products Technical Support personnel.

### VEHICLE INFO

Vehicle Info contains important information about your vehicle. This information will help Edge Products Technical Support by letting them know all of the specifics of your vehicle.

### CONTACT INFO

The Contact Information menu contains the Edge Products web site URL, the company address, the Technical Support e-mail address, and the Technical Support phone number.

This information will be useful if you need to contact Edge Products for warranty claims, sales information, upgrade information or any other technical questions/inquiries.

### TECH SUPPORT TOOLS

The Technical Support Tools menu contains tools made specifically to help Edge Products Technical Support representatives help customers when they are experiencing problems with their vehicle or device. This menu should only be used when

EVOLUTION

PROGRAMMING

**NOTE:** It is important to unplug all power consuming devices (plugged into the cigarette lighter). If you are receiving errors or your display is stuck on the “Uploading bootloader” screen, refer to the trouble shooting guide at the back of this manual for more information.

USING LEVELS

The CS/CTS device comes ready with power levels to be programmed into your vehicle’s Power Control Module (PCM) (see the Power Levels section of the manual for further detailed Power Level descriptions). You can choose these levels by entering the Programming menu (under the Main Menu), and choosing from one of the listed Power Levels. (Figure 24)

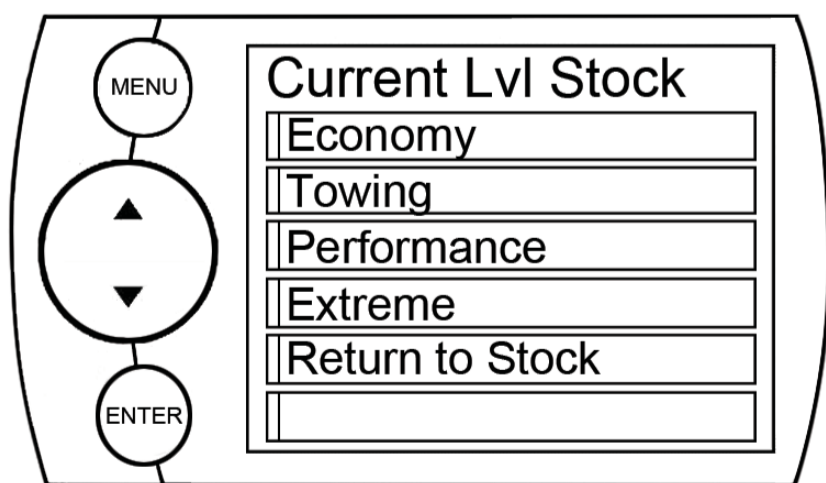

Figure 24

**NOTE:** Figure 21 depicts the programming level options for a GM product. If you have another make such as Ford or Dodge, you will notice that the levels available for your vehicle will vary from the GM options. For example, if you own a 97-09 F150, the economy level option is not available and cannot be added.

Select the power level that best suits your needs. Follow the instructions on the screen. Evolution programming is done while the vehicle is parked and away from traffic or where the vehicle may impede access, or exit. Programming will take several minutes and the vehicle can not be started.

**WARNING:** Do not combine, or “stack” chips (modules) to gain more horsepower. The chips could be incompatible and result in power-train failure or create dangerous conditions leading to a serious or fatal accident.

CUSTOM OPTIONS

After choosing a power level to program your vehicle with the Evolution, you will be prompted with the option to “Create



a custom program.” Choosing **YES** will load the **Custom Options** menu. (Figure 25)

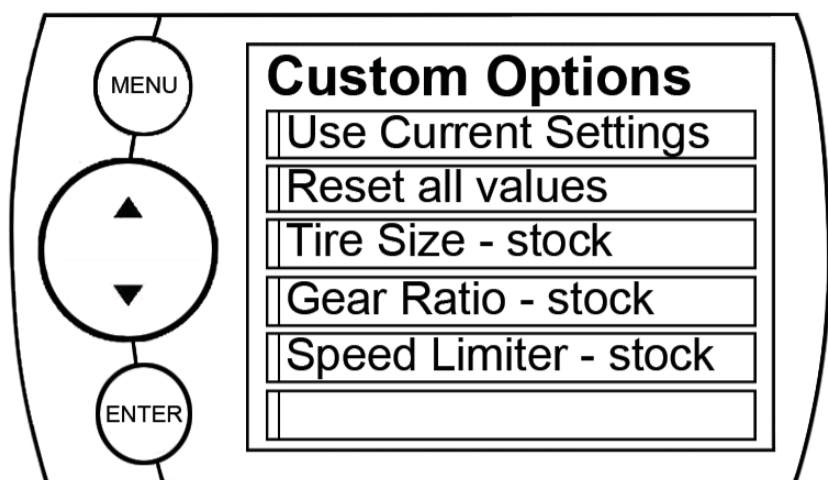

Figure 25

This will allow you to change certain parameters of the level you choose. Selecting **NO** will program a standard power level.

### **USE CURRENT SETTINGS**

This option will use the previously selected options.

### **RESET ALL VALUES**

This option will restore all of the settings back to factory defaults.

### **TIRE SIZE**

This option will allow you to select a new tire size if you've changed the factory tires.

### **GEAR RATIO**

This option will allow you to select a new gear ratio if you've changed the factory gears.

### **SPEED LIMITER**

This option will allow you to adjust the factory speed limiter higher or lower than the factory set speed limiter MPH.

Your Evolution programmer has the ability to remove/adjust

your vehicle's factory speed limiter. Removal/adjustment of the factory speed limiter is intended for use at a closed circuit, legally sanctioned racing environment. Even if racing in a legally sanctioned racing environment, it is your responsibility to ensure your tires and other vehicle components are rated to travel at increased speeds with the speed limiter removed/adjusted.



**WARNING:** *If you drive on public roads after removal or adjustment of the speed limiter, you must still obey all driving laws, including adhering to posted speed limits. To drive at racing speeds on public roads seriously endangers you, your passengers, and others nearby. Driving at high speeds with inadequate tires or other components can lead to serious or fatal injury.*

**CAUTION:** *Removing/adjusting the speed limiter for purposes inconsistent with the product's intended function violates the product's intended use and will invalidate the product's warranty. Edge Products is not responsible for, or liable for the consequences*

*of improper product use.*

During programming, the CS/CTS device will go through a series of screens telling you the action it is completing.

Follow the on screen instructions.

After the CS/CTS device has successfully programmed your vehicle, the programmed level number will appear on the main screen in the level indicator box.

***NOTE: Do not be alarmed if your lights flash, your dash chimes, or your doors automatically lock and unlock during the programming process. These operations are normal.***

## POWER LEVELS



***WARNING: Performance and Extreme levels are not intended for, and should not be used for towing. Do not exceed your vehicle's max GVWR as outlined in the vehicle's owner's manual. Doing so may result in loss of vehicle control and cause bodily injury.***

The CS/CTS Evolution typically has 4 power levels, and each is tuned specifically for different driving situations. The level names are reflective of what the

driving level should be used for.

***TRANS ONLY-*** The Trans Only level only makes changes to the transmission. It will provide firmer transmission shifts which help increase transmission life.

***ECONOMY -*** The economy level is the lowest power setting. It has been specifically tuned for optimum fuel economy, we recommend using this level for daily driving.

***TOWING -*** The towing level is designed for towing, Tuning strategies are optimized to provide power where it is needed most in order to move a load.

***PERFORMANCE -*** The Performance level is a high power level. The fuel injection and timing strategies are tuned semi aggressively to extract substantial power gains from the vehicle without sacrificing drive-ability or durability.

***EXTREME -*** This is the highest setting for the Evolution. The fuel injection and timing strategies are aggressively tuned to extract high performance from your vehicle without sacrificing drive-ability or durability.



**RACE EVOLUTION**

*NOTE: Most racing is done with modified, free-flowing exhaust systems. Regeneration should be disabled.*

**CAUTION 2008-2010 FORD****6.4L RACE EVOLUTIONS:**

*When you remove your DPF, you will need to replace it with a “Delete Pipe” which has sensor replacement fittings. Install your stock sensors in these*

*fittings. Failure to install the stock sensors may cause your vehicle to become disabled.*

**ATTITUDE**

*NOTE: In order for the CS/CTS to function properly; the JAB, Juice Module, and OBDII cables must first be installed and connected to the Attitude Monitor (CS/CTS). Refer to the EAS and JUICE Installation Guides as well as the Quick Install Guide for more information on how to install these devices.*

est power output.

Level 1 or 2 are suitable for Towing, while levels 4 and higher are used when you desire a high power output from the vehicle and have modified or upgraded your power and drive trains.

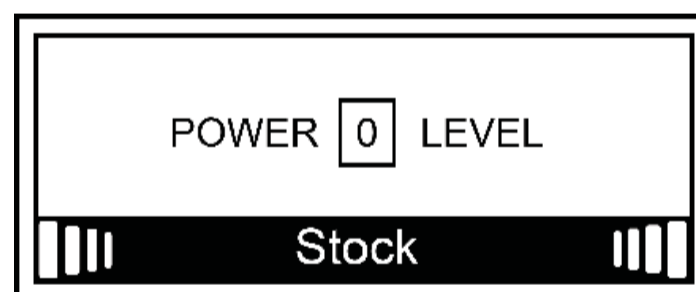

Figure 26

**POWER LEVELS**

The CS/CTS Attitude has up to 5 power levels (6 with the optional Hot Unlock). The level names reflect what the driving level should be used for. (Figure 26) Incremental touch or press of the up/down arrow buttons changes the level as shown. Level 1 has the lowest power output, and level 5 has the high-

**MILEAGE**

Specific tuning for optimum fuel economy under normal driving.

**TOW**

Tuning strategies are optimized to provide power where it is needed most when moving a load.



**DRIVE**

Specific tuning for daily all-around driving and performance.

**RACE**

Race Performance Tune. The fuel injection and timing strategies are aggressively tuned to extract substantial power gains from the vehicle without sacrificing drive-ability or durability.

**EXTREME**

The fuel injection and timing strategies are aggressively tuned to extract high power and performance from your vehicle.

**JUICE CONTROL**

The Juice Control menu allows you to regulate engine power delivery and drive-train performance, by enhancing the ECM factory settings through the Juice Module. The following settings may or may not be available depending on your make of vehicle and/or your Edge product. (Figure 27)

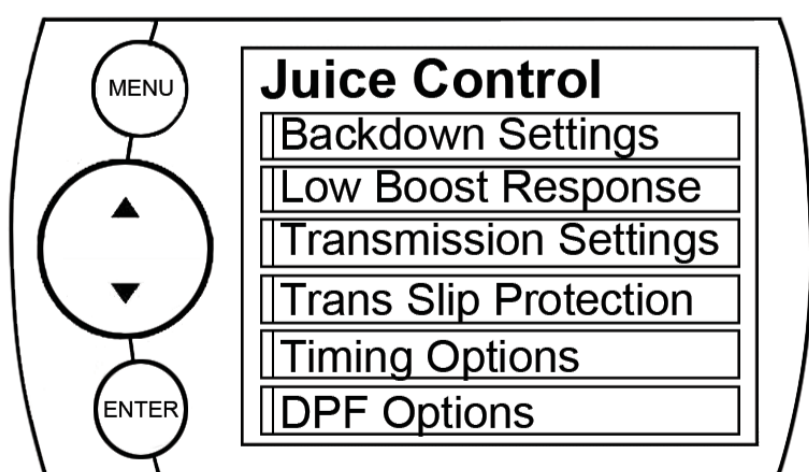

Figure 27

**BACK-DOWN SETTINGS**

**EGT BACK-DOWN**

The Attitude monitors the Exhaust Gas Temperature (EGT) and will automatically de-fuel the vehicle at your specified max EGT set point.

As the exhaust gas temperature approaches the EGT set point, a percentage of de-fueling occurs. This percentage is shown as the back-down value you can view on the Attitude display if selected as an option. When this value reaches 100% the fueling delivered by the Juice module has been totally disabled. However, stock fueling will allow the vehicle to reach EGT levels which may exceed the preset Max EGT Set Point.

**CAUTION: Other high performance modifications in addition to the Juice can allow the fueling to exceed the max set point and stock EGT levels, even after 100% de-fueling by the Attitude. This may result in detrimental EGT levels and potential power-train damage.**

**CAUTION: On the 1999-2003 Ford 7.3L, EGT Back-down will remove even the stock power in order to limit EGT**

**COLD ENGINE PROTECTION**

This feature restricts the Juice module from adding more power until the engine has reached a minimum temperature. As the engine warms up, more power is added until a specific engine temperature is reached at which point 100% Juice power is available.

*(NOTE: The 1999-2003 Ford 7.3L uses Engine Oil Temperatures to determine when and how much additional power is to be added.)*

**LOW BOOST RESPONSE**

This setting will allow you to change the performance response at low engine speed or boost levels. Select the power level for which you want to adjust the Responsiveness. Select your level of responsiveness. 1 being the lowest and 5 being the highest.

**TRANSMISSION SETTINGS**

These settings will allow you to de-fuel during shift and torque converter lock.

*NOTE: We recommend choosing de-fueling (Yes) during torque converter or clutch slip for stock transmissions. Selecting (No) prevents the Juice*

*module from de-fueling when the torque converter or clutch is slipping.*

**CAUTION:** *Selecting (No) will allow the Juice to fuel when the transmission slips. (Yes) eases the transmission strain because the Juice lowers its power output when the torque converter or clutch is slipping.*

**TRANS SLIP PROTECTION**

In some cases, this option will be available under the “TRANSMISSION SETTINGS” section. Refer to the previous section for more info.

**TIMING OPTIONS**

This option is only available on some Dodge diesel trucks. Choosing the Juice Timing allows the timing to be matched to the Juice Power options. Choosing stock timing will allow the engine to run according to stock settings.

**AXLE RATIO**

This option is only available on Dodge diesel trucks. Follow all on screen instructions

**HOT UNLOCKER**

This optional power level is a high performance level, that

should only be used when the vehicle power and drive-train have been upgraded. **To unlock the power level**, you will need to:

1. Visit [www.edgeproducts.com](http://www.edgeproducts.com)
2. Click the “Hot Unlock Form” tab and save a copy to your computer.
3. Print out the form and fill out accordingly.
4. Follow instructions provided on the printout.

## **RACE ATTITUDE**

The Edge Racing Attitude is a device that interacts with the Edge Racing Juice Module to enhance your truck’s performance. You can change power levels on the fly while monitoring your trucks vital information.

The racing product you have purchased may include features that are not normally included with an Attitude.

### **DPF OPTIONS**

Refer to Figure 27 on previous page. Under the “JUICE CONTROL” menu, if DPF OPTIONS is listed on your device, refer to the following information:

### **MANUAL REGEN**

Follow all on-screen instructions. For more information, refer to the “MANUAL DPF REGENERATION” section under the “DIAGNOSTICS” section of this manual.

### **RESET DPF**

**CAUTION:** *Do not reset DPF data if the DPF is currently installed on the vehicle.*

After you have removed the DPF filter, use this feature to reset the DPF Data by selecting this option and pressing yes [ENTER]. This feature allows you to cancel a regeneration cycle if it were to begin while having the DPF removed from the vehicle.

## **PROGRAMMING**

Depending on your make and model, your Attitude may give you the option to program your PCM. If this is the case, refer to the Evolution section of this manual for more information on programming. Your CS/CTS will also guide you through the process.



## INSIGHT

**EFILIVE™****Adjust EFILive™ Tuned PCMS  
On-The-Fly!**

On 2001-2005 LB7 and LLY Duramax engines you can now change the power levels on-the-fly created by your EFILive™ custom tuning software with your Edge Insight CS or CTS! Simply use your EFILive™ software to change your DSP5 Switch Type from “hard wire” to “serial”. Once you are set up to support “serial” communication, simply use the up and down arrow buttons on your Insight to adjust EFILive™ tunes on-the-fly. Your current level will be displayed in the level indicator box. 5 custom levels (1-5) are usable with this feature.

TABLE OF CONTENTS

INTRODUCTION

PARTS DESCRIPTION

OPERATING INSTRUCTIONS

INTERNET UPDATES

APPENDIX

**USING ACCESSORIES**

**EAS**

The CS and CTS devices are equipped with an expandable accessories port which interfaces with the Edge Expandable Accessory System (EAS), as well as a video-in jack. (Figure 28)

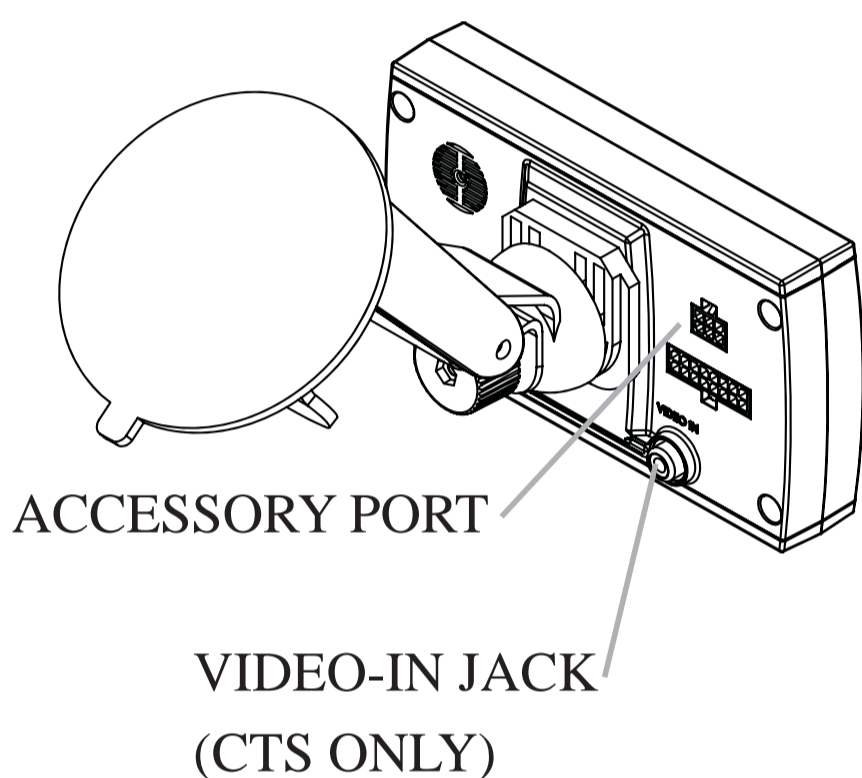

Figure 28

The EAS is an accessory network cable that transmits data between the CS or CTS and Edge Accessories.

With the EAS you can add multiple accessories to the CS or CTS using a daisy-chain-style connection system. (Figure 29)

Refer to your EAS Supplement Manual for instructions on how to properly install your EAS Devices.

**JAB (EAS)**

The JAB (Juice to Attitude Bridge) allows you to connect your Edge Juice Module to your CS or CTS device. This allows your CS or CTS to communicate with and control your Juice Module.

**EGT PROBE (EAS)**

The EGT (Engine Exhaust Temperature) sensor gives you direct engine temperature readings via a temperature probe. The EGT is plugged into the accessory port shown in Figure 28.

**EGT PROBE [STANDARD]**

If you are not interested in an expandable system, use the Standard Edge EGT probe (Figure 29). The standard EGT probe is not expandable with future accessories.

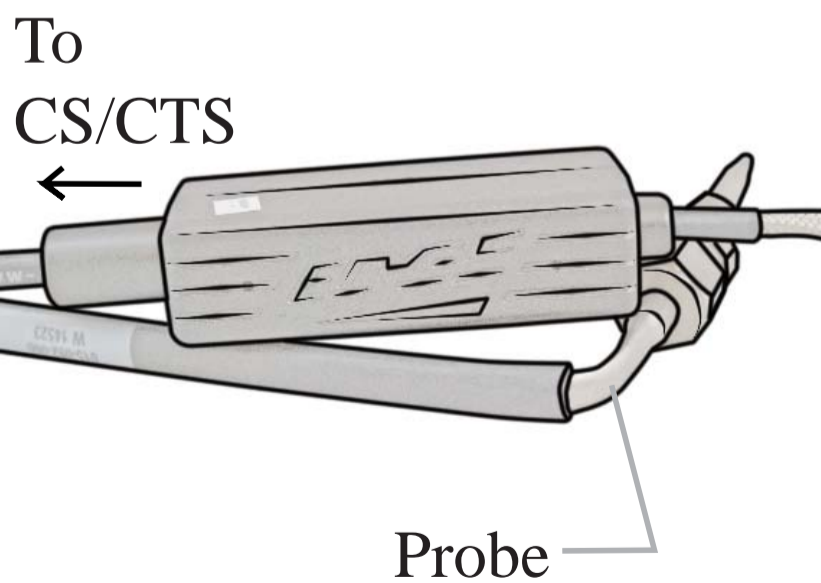

Figure 29

**EDGE BACKUP CAMERA**

Finish your CTS off with the Edge Products Backup Camera. (Figure 30) The Backup Camera provides a high-quality color image with “Night Vision” infrared LEDs allowing users to see objects in total darkness, up to a range of approximately 30 feet. The camera comes with a built-in, theft-resistant mount that installs easily using the license plate mounting screws/bolts. The custom Edge designed, theft-resistant mount is sturdy and stylish. The quick-release mount features a simple lock-and-key mechanism. The camera is also equipped with a magnetic back allowing users to mount the camera in different locations. The adjustable mounting bracket allows the user to adjust the viewing angle up and down to reach the desired viewing angle.

The CTS will work with most off-the-shelf back-up cameras that use an RCA style video connector. In addition to using the CTS as a back-up camera display device, you can also use it as a display for a DVD player, or other devices equipped with RCA video-out.



Figure 30

**To view or purchase any of our EDGE Accessories visit: [WWW.EDGEPRODUCTS.COM](http://WWW.EDGEPRODUCTS.COM) or contact your local EDGE PRODUCTS AUTHORIZED MVP DEALER.**

**EDGE MOUNTING SOLUTIONS****DASH PODS**

Edge Products offers the best custom mounting options on the market. Edge Products dash mounts (Figure 31) offer a unique solution for CS or CTS owners that are looking to add a factory finish look to their truck.



Figure 31



The pods are durable, made from high-quality plastic, and manufactured for a perfect fit and finish. They are angled for easy viewing, can be painted to match vehicle interior color (if needed), and are easy to install. The CS and CTS devices will fit in all Edge Products pods.

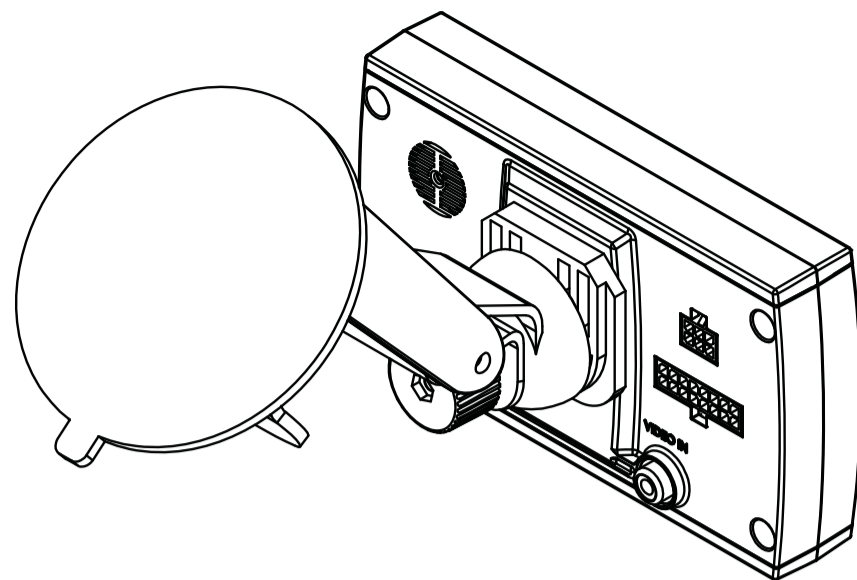

Figure 33

***NOTE: The CTS requires an adapter kit when used with Edge's Custom Dash PODs. (Figure 32)***



Figure 32

## SUCTION MOUNTS

Both CS and CTS devices come with a standard windshield mount (Figure 30) manufactured by Arkon Resources Inc., the leader in device-mounting solutions. The CS and CTS devices have a standard two-tab system built in so they can accept an array of different Arkon mounts.

## C U S T O M I Z A T I O N

**BACK GROUND IMAGE**

When your display is in Analog Gauge Screen layout, you have a choice to change the background image.

1. Select **Options** inside the **Main Menu**.
2. Select **Screen Layout** and choose the **Analog Gauge Screen**.
3. When the **Analog Gauge screen** displays, you will have the option to choose from 10 different screen backgrounds. Scroll through options using the up/down arrows and then press enter or touch the screen to select.

Figures 34-36 are some example backgrounds:



Figure 34



Figure 35



Figure 36

**USING MYSTYLE**

Create and add your own custom background using the unique Edge Products My-Style™ Software included with your CD or download from the Edge Products website.

Your background is limited only by your imagination! Have a picture of your family, truck, pet or logo? ...easily add it by connecting your device to your computer and use the MyStyle™ Software.



**FUSION UPDATE SOFTWARE**

**\*\*\*REQUIRES INTERNET CONNECTION\*\*\***

Fusion Software allows the user to update their device to the latest version of firmware and calibration files. This software is included on the CD provided with your device. It can also be downloaded for free from Edge Products web site at [www.edgeproducts.com](http://www.edgeproducts.com) or the CD can be requested by calling 888-360-EDGE (3343).

***NOTE: Be sure to install both the SOFTWARE and the DRIVERS that come included in the download or on the CD before you connect your device to your PC. During the installation you will be prompted to install the drivers, choose yes. For step by step installation instructions please copy this link into your web browser: [http://www.edgeproducts.com/product\\_images/product\\_update-file-11.pdf](http://www.edgeproducts.com/product_images/product_update-file-11.pdf)***

**USING THE SOFTWARE**

***NOTE: The CS/CTS device should not be plugged into the vehicle's OBDII port and your computer's USB port at the same time. Only the USB is needed to update.***

1. Click the Fusion icon on your PC desktop once you've installed Fusion.
2. If you have not yet created an account, click on "Create a New User". You will then be directed to a web page to create your login information.

***NOTE: After entering your information, a password will be sent to the e-mail address you provide. Be sure your e-mail account doesn't block e-mails from [www.edgeproducts.com](http://www.edgeproducts.com).***

3. Upon receiving the password, enter your e-mail address and password on the login screen of the Fusion Software.
4. You'll be prompted to connect the device to launch. After connecting the device, you'll see a screen pop-up.(Figure 37)
5. Click yes to continue with the update.

***NOTE: Be sure to return your vehicle to stock before connecting the device to Fusion.***

***NOTE: Plug both USB connectors into the computer before connecting the device***



*to ensure proper operation. If only one can be used, plug in the USB that is part of the long cable. The short pigtail can not be used alone.*



Figure 37

After you've selected **yes** on the previous screen (Figure 37) the Fusion software will go through the steps in order to update the device. Once it's completed you'll see the following screen. (Figure 38)



Figure 38

6. Click OK and the update will be completed. You'll now have the latest Firmware, and Calibration on your device.

When your device is connected to Fusion, the device model, Lvl, Bootloader, Firmware, Calibration and Serial Number are all displayed at the bottom of the screen. These numbers will be useful to quickly view the state of your device, and whether or not it is currently programmed to a vehicle.

- **MODEL** : The model number for your device.
- **LVL** : The currently programmed level.
- **BOOTLOADER** : The boot loader version currently on your device.
- **FIRMWARE** : The firmware version currently on your device.
- **CALIBRATION**: The calibration version currently on your device
- **SERIAL NUMBER** : The serial number assigned to your device

## PROGRAMMING ERRORS

### UPDATE REQUIRED

Fusion is designed to help the development team at Edge Products support new vehicle calibrations.

When you connect your device to the vehicle, the first step it takes is identifying your vehicle's stock file. If the stock file isn't currently supported:

1. The device will display a screen alerting you that the **stock file is not yet supported.**
2. It will then prompt you to **press a button/touch the screen** in order to read and save the stock file.
3. Once the device has saved the stock calibration, it will prompt you to **connect the device to Fusion.**
4. Fusion will ask you if you want to upload your vehicle's stock files to our server. Choosing **Yes** will upload the files to the server, and alert the development team. This will help the development team at Edge Products provide support for your vehicle's calibration as quickly as possible.

### NON-STOCK CONDITION

During programming, the device will read the stock file on

your vehicle and compare it to a corresponding stock file that has been verified by Edge Products. If there is a **mis-match**, the device will alert you, and display this message: *“Non-stock condition detected. This is most likely because your vehicle has been programmed with a competitive product. It is recommended that you return your vehicle to a stock condition with the product that changed it. Alternatively, you can plug your device into your computer and it will load the necessary files onto your device to return your vehicle to stock.”*

If you don't have the competitive product that programmed your truck:

1. Connect the device to Fusion (via USB connector) where you'll be prompted to download the correct stock files.
2. Once downloaded, simply connect the device to your vehicle (via OBDII), and the device will program the verified stock files to your vehicle.

O E M E G T L O C A T I O N S

*NOTE: This section refers to diesel vehicles*

The 2007.5 and newer light-duty diesel pickups are equipped with OEM Exhaust Gas Temperature (EGT) sensors, all of which can be monitored with the CS and CTS Devices.

Before a customer uses the vehicle's OEM sensors for reading exhaust gas temperature, it's extremely important that he/she become educated about EGT sensor placement, and understand what exactly to look for when using an EGT sensor on a diesel-powered vehicle. (NOTE: Additional detailed installation instructions are found in supplemental manuals)

Edge Products was the first company to integrate gauge screens with their power modules giving customers the ability to monitor EGTs and other vehicle parameters in real-time. Since the introduction of the Attitude monitor Edge Products has always recommended that the EGT probe be placed in the exhaust manifold, in a pre-turbo location simply because the manifold location gives the best representation of combustion chamber temperatures. Other locations downstream in the ex-

haust system do not accurately represent combustion chamber temperatures.

The 2008 and newer Ford Powerstroke 6.4L is factory-equipped with an EGT sensor in the pipe prior to the high pressure turbo. This EGT sensor accurately represents EGT temperatures in the combustion chamber.

The 2007.5+ GM Duramax and Dodge Ram 6.7 Cummins do not have EGT sensors placed pre-turbo where the optimum readings can be achieved. When items such as turbos, catalyts, NOX filters, and particulate traps are introduced, temperatures can vary in large margins due to the thermal energy stored/transferred by these devices. This creates an environment that doesn't represent combustion-chamber temperatures as effectively as a manifold/pre-turbo placed sensor does.

Edge Products recommends using a pre-turbo EGT sensor if you use the CS/CTS for any kind of competition, or heavy hauling. If your vehicle is not equipped with a pre-turbo EGT

TABLE OF CONTENTS

INTRODUCTION

PARTS DESCRIPTION

OPERATING INSTRUCTIONS

INTERNET UPDATES

APPENDIX



sensor, Edge recommends you purchase an Edge Products sensor and install it in a pre-turbo location.

As noted in the accessories section, you can purchase an Edge Products EGT sensor to be coupled with the Edge Accessories System (EAS) or you can purchase a standalone Edge EGT sensor. Either of these items can be purchased at [www.edgeproducts.com](http://www.edgeproducts.com) or at your local Edge Products Authorized MVP Dealer.

If you are unsure whether or not your vehicle is equipped with a pre-turbo EGT sensor please see the diagram on the following page.

If you are unsure what temperature range is acceptable on your EGT's we recommend you do the following:

- 1 - Display EGTs on your main display screen
- 2- Observe what EGTs are displayed while at a stock power level and accelerating at a heavy load, i.e. pulling a heavy trailer up a long hill.
- 3 - 1350 F is the highest recommended exhaust gas temperature.

The following Illustrations represent the 2007.5 + light-duty diesel pickups.

**(NOTE: Additional EGT installation instructions can be found in the Juice Supplement Installation Instructions manual as well as the EAS Installation Instruction manual.)**

The Dodge 6.7 Cummins is not equipped with a pre-turbo EGT sensor. It is however equipped with three EGT sensors downstream from the turbo. All of these sensor's readings are available for display on the CS and CTS. However they are not an accurate representation of combustion chamber temperatures. (Figure 39)

The GM LMM Duramax is not equipped with a pre-turbo EGT sensor. It is however equipped with two EGT sensors downstream from the turbo. Both of these sensor's readings are available for display on the CS and CTS. However they are not an accurate representation of combustion chamber temperatures. (Figure 39)

The Ford 6.4 Powerstroke has an EGT sensor placed in the passenger side up pipe prior to the turbo. This is an excellent location for an EGT sensor. The readings you'll see here represent the temperatures in the combustion chamber than the temperatures you would see down stream. (Figure 39)

TABLE OF CONTENTS

INTRODUCTION

PARTS DESCRIPTION

OPERATING INSTRUCTIONS

INTERNET UPDATES

APPENDIX

# Modern Light-Duty Diesel Truck Exhaust Illustrations

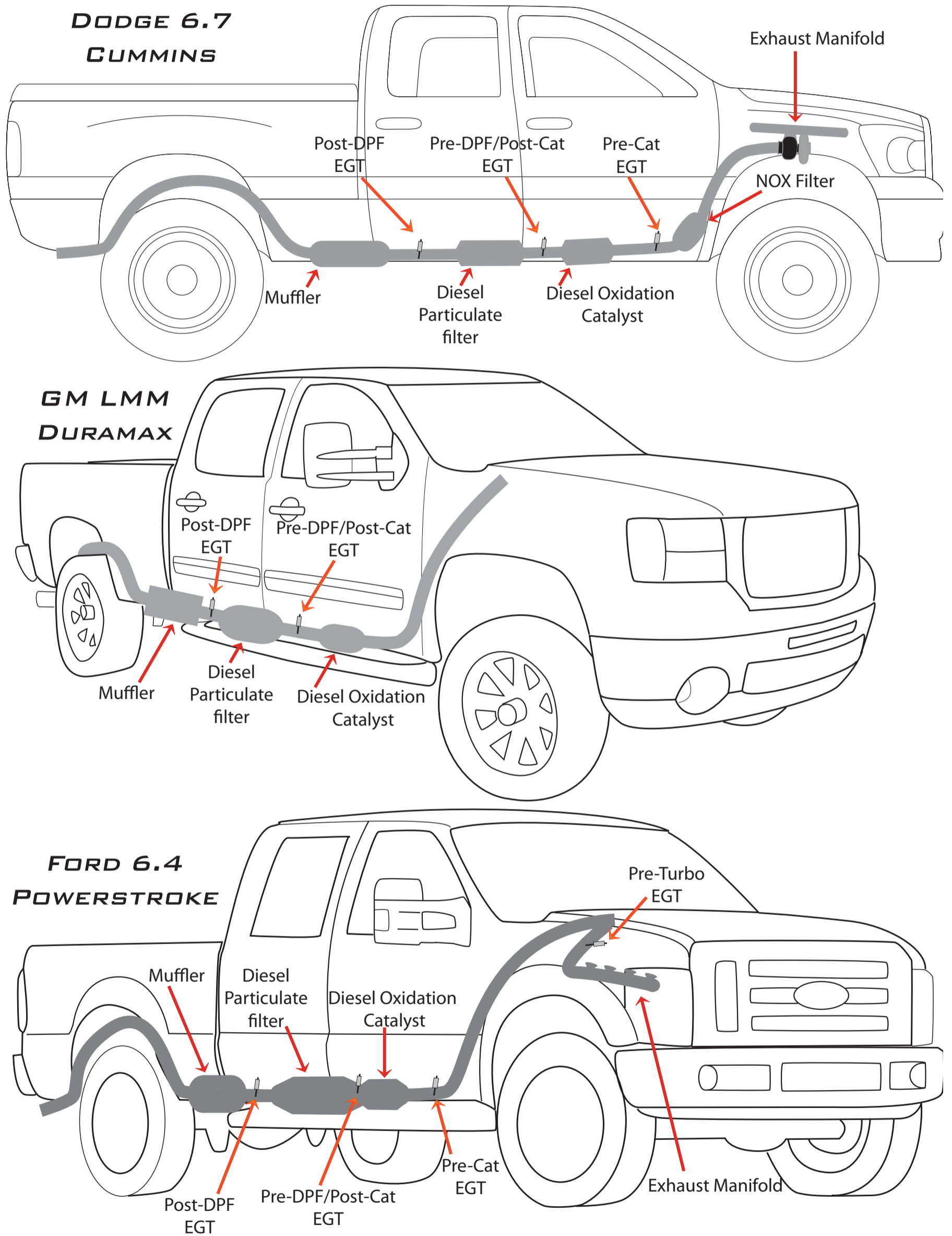

Figure 39

**T I P S / T R O U B L E S H O O T I N G**

Tip: Programming your vehicle may expose existing defects in your PCM that could disable your vehicle. It is advised that you do not program in remote locations in case of failure. Vehicle manufacturers do not recommend programming in extreme temperature. Please see your vehicle service manual to ensure that programming is being done in accordance to the original equipment manufacturers specifications.

Tip: Keep in mind that the CS/CTS is a high performance product and that not all vehicles deliver the exact same power output when programmed with the CS/CTS. It is recommended that you select a program that will best fit your needs. Whether towing, or traveling long distances at high speeds, choose your power level wisely and keep in mind the condition and tolerances of your vehicle when selecting a suitable power level.

Tip: If any problems persist, contact Edge Technical Support. Please have the product Serial Number and Vehicle Information prior to calling Technical Support. This will help ensure quick and accurate support.

Tip: When taking your vehicle to the dealership to get the oil changed or to get other work done, it is always a good idea to program the truck to stock before taking it in for service. In many cases, the dealership has new updates for the truck, and consequently will update the vehicles computer. If this is an Evolution product and is programmed to a power level, the dealership update will over write the programming and lock the device.

Always program the truck to stock, and update the product on Fusion while it is out of the truck to ensure that the software on the Evolution is up to date with the software the dealer installs in the vehicle.

Tip: Plugging both USB Cables into your computer will improve the connection between your CS/CTS and Computer.



TABLE OF CONTENTS

INTRODUCTION

PARTS DESCRIPTION

OPERATING INSTRUCTIONS

INTERNET UPDATES

APPENDIX

TROUBLE SHOOTING GUIDE		
SYMPTOM	POSSIBLE CAUSE	SOLUTION
Display beeps for two seconds (long beep)	The unit is too hot from being in the direct sunlight	Once the device cools down the screen will turn itself on
No display when the key is in “on” position	The unit will not wake up with the key in the “on” position until the screen is touched or any button is pressed	Touch the screen or start the vehicle, if this does not turn the screen on then you will need to call technical support
Vehicle does not start after programming	The calibration may have not written correctly	Select “Return to stock” from the programming menu. Then, Program back to stock. Now, try to start the vehicle again. If the problem continues contact technical support
Fusion drivers will not install correctly	The drivers were not successfully installed by the automatic installer	Manually install the drivers, Edge technical support can provide you with instruction on how to do this
Camera picture is frozen	Bad connections	Cycle the key off and on. Double check your fuse and connectors.
Error 16 when programming	There was a communication error	Try to program the level again
Display beeps quickly	Possible device malfunction	Update the device using the fusion software
Edge EGTs are not displaying	Connector on the back of the device is not fully seated	Make sure the cable connection is not upside down, and push the cable until it is fully seated
Unit will not power on after vehicle is started or after screen or buttons are pressed.	Typically this issue is caused by a blown OBDII/Cigarette Lighter Fuse.	Replace fuse and test unit again.
<p>Evolution programming errors:</p> <ol style="list-style-type: none"> <li>1. Your device gets stuck on the “Uploading Boatloader” screen</li> <li>2. An error is displayed: “ERROR-We could no upload the bootloader to the vehicle...”</li> <li>3. If you are constantly asked to make sure your key is on.</li> <li>4. Error displayed after your device shows blank gauges and says that it is loading. The error will be displayed as “Cannot communicate with vehicle, ensure the key is in the on position...”</li> </ol>	<p>Sometimes programming can be disrupted by installed aftermarket devices that are tapped into the trucks communication lines (J1850). These may include but are not limited to aftermarket radios, chime boxes, remote starters, ect.</p> <p>Also, any power consuming devices should not be plugged into the cigarette adapter during the programming process. Fluctuations in power may disrupt the programming process.</p>	<p>The following solutions are good first steps to getting around these programming errors. If these steps do not solve your problem, please contact Edge Tech Support:</p> <p><b>Fuses: (CAUTION: Always turn the key off while unplugging fuses).</b></p> <ol style="list-style-type: none"> <li>1. Remove fuses connecting radio, radio amplifier, satellite radio, remote starter, or any other aftermarket device you have installed on your vehicle.</li> </ol> <p><b>Power:</b></p> <ol style="list-style-type: none"> <li>1. Close all doors during programming.</li> <li>2. Do not operate electrical accessories (radio, windows, wipers, ect.)</li> <li>3. Remove any devices plugged into the cigarette lighter or any other auxiliary power port.</li> </ol>

**C O M M O N L Y U S E D A C R O N Y M S**

ACT = Air Charge Temp	KS = Knock Sensor
ACV = Air Control Sensor	LOAD = Engine Load
AOD = Automatic Overdrive Transmission	LOS = Limited Operation Strategy
APP = Accelerator Pedal Position	LPD = Line Pressure Desired
BAT = Battery Voltage	LUS = Lock-up Solenoid
BCM = Body Control Module	MAF = Mass Airflow
BOO = Brake On/Off Switch	MAFV = Mass Airflow Sensor Voltage
BP = Barometric Pressure Sensor	MAP = Manifold Absolute Pressure
CCD = Computer Controlled Dwell	MAT = Manifold Air Temp
CCO = Converter Clutch Override	MCU = Microprocessor Control Unit
CDR = Crankcase Depression Regulator	MIL = Malfunction Indicator Light
CEL = Check Engine Light	MPH = Miles Per Hour
CFI = Central Fuel Injection	OHC = Over Head Camshaft
CHT = Cylinder Head Temperature	OSS = Output Shaft Speed
CID = Cylinder Identification Sensor	PCM = Powertrain Control Module
CKP = Crank Position Sensor	PFE = Pressure Feedback EGR Sensor
CMP = Cam Position Sensor	PIP = Profile Ignition Pickup
CPS = Crankshaft Position Sensor	PSPS = Power Steering Pressure Switch
CS = Color Screen	RPM = Revolutions Per Minute
CTS = Color Touch Screen	SES = Service Engine Soon
DPF = Diesel Particulate Filter	SIL = Shift Indicator Light
DTC = Diagnostic Trouble Codes	SPARK = Spark Advance/Retard
EAS = (Edge)Expandable Accessory System	SPOUT = Spark Output Signal
ECA = Electronic Control Assembly	STAR = Self Test Automatic Readout
ECM = Electronic Control Module	TAPS = Throttle Angle Position Sensor
ECT = Engine Coolant Temp	TCM = Transmission Control Module
EDF = Electric Drive Fan Relay	TFI = Thick Film Ignition System
EDIS = Electronic Distributor	TFT = Transmission Fluid Temperature
EGO = Exhaust Gas Oxygen Sensor	TGS = Top Gear Switch
EGR = Exhaust Gas Recirculation	TPS = Throttle Position Sensor
EGRC = EGR Control Solenoid	TQC = Torque Control
EOT = Engine Oil Temperature	TSS = Turbine Shaft Speed
EVP = EGR Position Sensor	TTS = Transmission Temperature Switch
EVR = EGR Valve Regulator	VAF = Vane Air Flow Sensor
FDM = Fuel Delivery Module	VAT = Vane Air Temperature
FPM = Fuel Pump Monitor	VCT = Variable Cam Timing
FRP = Fuel Rail Pressure	VSS = Vehicle Speed Sensor
HEGO = Heated Exhaust Gas Sensor	WAC = WOT A/C Cut-off Switch
IAT = Intake Air Temperature	WOT = Wide Open Throttle
ICM = Integrated Controller Module	
IDM = Ignition Driver Module	
ISC = Idle Speed Control	
ITS = Idle Tracking Switch	
IVS = Idle Validation Switch (Diesel)	
KAM = Keep Alive Memory	
KOEO = Key On Engine Off	
KOER = Key On Engine Running	

**I N D E X**

TABLE OF CONTENTS

INTRODUCTION

PARTS DESCRIPTION

OPERATING INSTRUCTIONS

INTERNET UPDATES

APPENDIX

**A**

- Accessory 43
  - Accessory Options 31
- Alert 4, 16, 17, 19, 20, 28, 29, 33, 49
  - Alert Options 28
  - Show Alerts 20, 21
  - Threshold 27, 28
- Autodim 30

**B**

- Back-down 16, 17
  - Cold Engine Protection 39
  - EGT Back-Down 39
- BackLight 30

**C**

- Camera 19, 44
- CARB 9
- Clear DTC Delay 22
- Clear on start 22
- Clutch Slip 40
- Cold Air Intake 8
- Cold Engine Protection 39
- Custom Options 35

**D**

- Diagnostics 21
- DPF 16, 17, 22, 23, 24, 55
  - DPF Options 41
- DTCs 22, 55

**E**

- EAS 31, 34, 43, 51, 55
- EGTs 23, 32, 39, 43, 50, 51
- EPA 9
- Errors 49

**F**

- Factory Reset 33
- Fusion Software 47

**G**

- Gauge 16, 17, 20, 29, 46

**H**

- Hot Unlock 38

**I**

- Injector Balance Rates 25

**J**

- JAB 43
- Juice Control 38

**L**

- Low Boost Response 39

**M**

- Maintenance Manager 26, 27
- Menu Timeout 30
- Mount 45
- Mystyle 46

**N**

- Non-Stock Condition 49

**O**

- OBDII 13, 15, 47, 49

**P**

- Performance Tests 24
  - 0-60 24
  - Quarter Mile 25
- Power Level 16, 17, 33, 35, 37, 38
- Pre-Turbo 50, 51
- Probe 43
- Programming 35, 49

**Q**



Quarter Mile. *See also* Performance Tests

**R**

Race 38, 40  
Records 25  
Regeneration 22

**S**

Safety 4, 5  
Screen Layout 16, 17, 29  
Serial Number 34, 48, 53  
Software 47  
Sound Duration 29  
Speed Limiter 5, 36  
Stacking 5

**T**

Technical Support 33, 34, 53  
Tire Size 30  
Torque Converter 40  
Transmission 55  
    Relearn 24  
Trouble Codes. *See* DTCs  
Turbo Cool Down 32

**U**

Units 32  
    English 31, 32  
    Metric 31, 32  
Update Required 49

USB 13, 14, 15, 47, 49, 53

**W**

Warranty 6, 7

**TABLE OF CONTENTS**

**INTRODUCTION**

**PARTS DESCRIPTION**

**OPERATING INSTRUCTIONS**

**INTERNET UPDATES**

**APPENDIX**

TABLE OF CONTENTS

INTRODUCTION

PARTS DESCRIPTION

OPERATING INSTRUCTIONS

INTERNET UPDATES

APPENDIX



**COPYRIGHT© 2010 REV 06**

*For additional questions not found in the user guide call:*

**Edge Products Technical Support: (888) 360-EDGE (3343) 8:00 am - 5:00 pm MST**

**To expedite your support call, please have your Vehicle Information,  
Part Number, and Serial Number ready prior to calling Technical Support.**

**The Edge Products information is found on the label located  
on the bottom of the device.**